

Cat. No. Z167-E1-06A

AMPLIFIER UNIT

V640-HAM11-V2

CIDRW HEAD

V640-HS61

CIDRW CONTROLLER

V700-L22

LINK UNIT

V700-L11

V640 SERIES

USER'S MANUAL

OMRON

Introduction

Thank you for purchasing the V640 Series CIDRW System.

Please observe the following points when operating the V640 Series:

- Please read and understand the content of this manual before using the system.
- After reading this manual, store it in a handy location for easy reference whenever necessary.

MEMO

Introduction	Table of Contents/Precautions in using the product
SECTION 1	Product Outline
SECTION 2	Installation and Connections/Wiring
SECTION 3	Preparing for Communications
SECTION 4	Reading from/Writing to ID Tags
SECTION 5	Troubleshooting
SECTION 6	Appendix

CIDRW System

V640-HAM11-V2

V640-HS61

V700-L22

V700-L11

Amplifier Unit

CIDRW Head

CIDRW Controller

Link Unit

User's Manual

READ AND UNDERSTAND THIS DOCUMENT

Please read and understand this document before using the products. Please consult your OMRON representative if you have any questions or comments.

WARRANTY

OMRON's exclusive warranty is that the products are free from defects in materials and workmanship for a period of one year (or other period if specified) from date of sale by OMRON.

OMRON MAKES NO WARRANTY OR REPRESENTATION, EXPRESS OR IMPLIED, REGARDING NON-INFRINGEMENT, MERCHANTABILITY, OR FITNESS FOR PARTICULAR PURPOSE OF THE PRODUCTS. ANY BUYER OR USER ACKNOWLEDGES THAT THE BUYER OR USER ALONE HAS DETERMINED THAT THE PRODUCTS WILL SUITABLY MEET THE REQUIREMENTS OF THEIR INTENDED USE. OMRON DISCLAIMS ALL OTHER WARRANTIES, EXPRESS OR IMPLIED.

LIMITATIONS OF LIABILITY

OMRON SHALL NOT BE RESPONSIBLE FOR SPECIAL, INDIRECT, OR CONSEQUENTIAL DAMAGES, LOSS OF PROFITS OR COMMERCIAL LOSS IN ANY WAY CONNECTED WITH THE PRODUCTS, WHETHER SUCH CLAIM IS BASED ON CONTRACT, WARRANTY, NEGLIGENCE, OR STRICT LIABILITY.

In no event shall responsibility of OMRON for any act exceed the individual price of the product on which liability is asserted.

IN NO EVENT SHALL OMRON BE RESPONSIBLE FOR WARRANTY, REPAIR, OR OTHER CLAIMS REGARDING THE PRODUCTS UNLESS OMRON'S ANALYSIS CONFIRMS THAT THE PRODUCTS WERE PROPERLY HANDLED, STORED, INSTALLED, AND MAINTAINED AND NOT SUBJECT TO CONTAMINATION, ABUSE, MISUSE, OR INAPPROPRIATE MODIFICATION OR REPAIR.

SUITABILITY FOR USE

THE PRODUCTS CONTAINED IN THIS DOCUMENT ARE NOT SAFETY RATED. THEY ARE NOT DESIGNED OR RATED FOR ENSURING SAFETY OF PERSONS, AND SHOULD NOT BE RELIED UPON AS A SAFETY COMPONENT OR PROTECTIVE DEVICE FOR SUCH PURPOSES. Please refer to separate catalogs for OMRON's safety rated products.

OMRON shall not be responsible for conformity with any standards, codes, or regulations that apply to the combination of products in the customer's application or use of the product.

At the customer's request, OMRON will provide applicable third party certification documents identifying ratings and limitations of use that apply to the products. This information by itself is not sufficient for a complete determination of the suitability of the products in combination with the end product, machine, system, or other application or use.

The following are some examples of applications for which particular attention must be given. This is not intended to be an exhaustive list of all possible uses of the products, nor is it intended to imply that the uses listed may be suitable for the products:

- Outdoor use, uses involving potential chemical contamination or electrical interference, or conditions or uses not described in this document.
- Nuclear energy control systems, combustion systems, railroad systems, aviation systems, medical equipment, amusement machines, vehicles, safety equipment, and installations subject to separate industry or government regulations.
- Systems, machines, and equipment that could present a risk to life or property.

Please know and observe all prohibitions of use applicable to the products.

NEVER USE THE PRODUCTS FOR AN APPLICATION INVOLVING SERIOUS RISK TO LIFE OR PROPERTY WITHOUT ENSURING THAT THE SYSTEM AS A WHOLE HAS BEEN DESIGNED TO ADDRESS THE RISKS, AND THAT THE OMRON PRODUCT IS PROPERLY RATED AND INSTALLED FOR THE INTENDED USE WITHIN THE OVERALL EQUIPMENT OR SYSTEM.

PERFORMANCE DATA

Performance data given in this document is provided as a guide for the user in determining suitability and does not constitute a warranty. It may represent the result of OMRON's test conditions, and the users must correlate it to actual application requirements. Actual performance is subject to the OMRON Warranty and Limitations of Liability.

CHANGE IN SPECIFICATIONS

Product specifications and accessories may be changed at any time based on improvements and other reasons.

It is our practice to change model numbers when published ratings or features are changed, or when significant construction changes are made. However, some specifications of the product may be changed without any notice. When in doubt, special model numbers may be assigned to fix or establish key specifications for your application on your request. Please consult with your OMRON representative at any time to confirm actual specifications of purchased products.

DIMENSIONS AND WEIGHTS

Dimensions and weights are nominal and are not to be used for manufacturing purposes, even when tolerances are shown.

ERRORS AND OMISSIONS

The information in this document has been carefully checked and is believed to be accurate; however, no responsibility is assumed for clerical, typographical, or proofreading errors, or omissions.

PROGRAMMABLE PRODUCTS

OMRON shall not be responsible for the user's programming of a programmable product, or any consequence thereof.

COPYRIGHT AND COPY PERMISSION

This document shall not be copied for sales or promotions without permission.

This document is protected by copyright and is intended solely for use in conjunction with the product. Please notify us before copying or reproducing this document in any manner, for any other purpose. If copying or transmitting this document to another, please copy or transmit it in its entirety.

To Users of Model V700-L21

The V700-L22 is the CIDRW controller complying with the 2003 edition of the SEMI E99 standard. A V700-L21 cannot simply be replaced with a V700-L22. If you wish to replace a V700-L21, bring the CIDRW controller control program into line with the new stipulations as described in this manual.

■ Main Points of Difference with the V700-L21

- Addition of support attributes

The CIDRW attributes defined as CarrierIDOffset and CarrierIDLength in the 2003 edition of the SEMI E99 standard have been added.

With the V700-L22, the user can now specify as attributes the position of the MID in the ID tag, and the data length.



Refer to Support Attributes p.134.

- Changes in message specifications

The 2003 edition of SEMI E99 adds a format definition for the message specification data item MID.

The specifications of the data item MID have changed in the V700-L22.



Refer to Message Specifications p.70.

- Addition of a data area access function

The V700-L22 has added a function for specifying ID tag data area access destinations as offset addresses.

The V700-L21 divides the data area into 8-byte units called segments, and reads and writes data to each segment. Besides this, the V700-L22 also allows you to specify offset addresses referenced to the first address in the ID tag data area, so that data can be read and written in units of one byte.



Refer to Message Specifications p.70.

- Replacing a V700-L21 with a V700-L22

The following settings are required to replace a V700-L21 with a V700-L22.

- (1) Set the attributes CarrierIDOffset and CarrierIDLength.

Set CarrierIDOffset to 0 and for CarrierIDLength set the data length of the data item MID specified by the ID write request (S18F11). If there is a mismatch between the CarrierIDLength attribute and the MID length in the ID write request (S18F11), a CE (communications error) occurs, and no data is written.

- (2) Change the MID to data comprising displayable ASCII characters only.

With the V700-L22, data that includes undisplayable ASCII characters cannot be read with an ID read request (S18F9); an EE - execution error - occurs. Data including undisplayable ASCII characters in the MID cannot be specified with an ID write request (S18F11).



CHECK!

With the V700-L21, the MID to be read or written is consigned to an area fixed at 16 bytes. If the specified data length in the ID write request (S18F11) is less than 16 bytes, NULs are added in internal processing to make the total up to 16 bytes. In contrast, with the V700-L22, the accessible MID data occupies only the area specified by the attributes CarrierIDOffset and CarrierIDLength. Remember that data can only be read or written in the area specified by the attributes.

Applicable Standards

1. FCC Rules (Federal Communications Commission)

This device complies with Part 15 Subpart C of the FCC Rules.

FCC ID: E4E6CYCID6400202

Operation is subject to the following two conditions:

- (1) this device may not cause harmful interference, and
- (2) this device must accept any interference received, including interference that may cause undesired operation.

FCC NOTICE

This equipment has been tested and found to comply with the limits for a Class B digital device, pursuant to part 15 of the FCC Rules. These limits are designed to provide reasonable protection against harmful interference in a residential installation.

This equipment generates, uses and can radiate radio frequency energy and, if not installed and used in accordance with the instructions, may cause harmful interference to radio communications. However, there is no guarantee that interference will not occur in a particular installation. If this equipment does cause harmful interference to radio or television reception, which can be determined by turning the equipment off and on, the user is encouraged to try to correct the interference by one or more of the following measures:

- Reorient or relocate the receiving antenna
- Increase the separation between the equipment and receiver.
- Connect the equipment into an outlet on a circuit different from that to which the receiver is connected.
- Consult the dealer or an experienced radio/TV technician for help.

FCC WARNING

Changes or modifications not expressly approved by the party responsible for compliance could void the user's authority to operate the equipment.

Properly shielded and grounded cables and connectors must be used for connection to host computer and/or peripherals in order to meet FCC emission limits.

CAUTION

This device must be professionally installed.

This CIDRW Head [Model: V640-HS61 (-X)] is dedicated to Amplifier Unit [Model: V640-HAM11-V2 (-X)].

2. EC Declaration of Conformity

Hereby, Omron, declares that this V640(-X) is in compliance with the essential requirements and other relevant provisions of Radio and Telecommunications Terminal Equipment Directive 1999/5/EC, and satisfy tests for the appropriate requirements of the following relevant standards.

Radio: EN300 330 V1.2.1 (May 1999)

EMC: EN301 489-3 (EN301 489-1)

Safety: EN61010-1: 1993+A2



3. Wireless Standards of China

V640-HAM11-V2/-HS61 CMII ID 2006DJ2071

4. Korean Radio Law

OMR-V64HAM11-HS61

Applicable SEMI Standards

This CIDRW system complies with the following standards.

- SEMI E99 THE CARRIER ID READER/WRITER FUNCTIONAL STANDARD
- SEMI E5 EQUIPMENT COMMUNICATION STANDARD 2 MESSAGE CONTENT (SECS II)
- SEMI E4 EQUIPMENT COMMUNICATION STANDARD 1 MESSAGE TRANSFER (SECS I)



SEMI is the acronym for Semiconductor Equipment and Materials International.
SECS is the acronym for SEMI Equipment Communications Standard.

Precautions for Safe Use

Please observe the following precautions for safe use of the products.

- Do not allow water to enter or insert wires through gaps in the case. This could cause fire or electric shock.
- In the event of a malfunction, stop using the product immediately, turn off the power, and consult your OMRON dealer.
- Dispose of this product as industrial waste.

Precautions for Correct Use

Please observe the following precautions to prevent failure to operate, malfunctions, or undesirable effects on product performance.

■ Installation Site

Install the product at a location where:

- It is not exposed to direct sunlight.
- It is not exposed to corrosive gases, dust, metal chips, or salt.
- The working temperature is within the range stipulated in the specifications.
- There are no sudden variations in temperature (no condensation).
- The relative humidity is within the range stipulated in the specifications.
- No vibration or shock exceeding the values stipulated in the specifications is transmitted directly to the body of the product.
- It is not subject to splashing water, oil, or chemical substances.

■ Mounting

- This product communicates with ID Tags using the 134 kHz frequency band. Some transceivers, motors, monitoring equipment, and power supplies (power supply ICs) generate electrical waves (noise) that interfere with communications with ID Tags. If you are using the product in the vicinity of any of these devices, check the effect on communications in advance.
- In order to minimize the effects of noise, ground nearby metal bodies with a grounding resistance not exceeding 100 ohms.
- When mounting Amplifier Units, tighten the screws with a torque no greater than 1.2 N·m.
- When mounting CIDRW Heads, tighten the screws with a torque no greater than 0.6 N·m.
- When multiple CIDRW Heads are mounted next to each other, communications performance could be impaired by mutual interference. Read and follow the information in this manual on mutual interference when installing multiple heads.



Refer to page 115.

■ Power and Ground Cables

- Use the power supply voltage specified in this manual.
- Ensure correct polarity when connecting to the +/- power supply terminals.
- The ground terminals must be connected to a ground with a grounding resistance not exceeding 100 ohms.

■ Wiring Work

- Always turn the power off before starting wiring work or connecting/disconnecting cables.
- Do not run high-voltage lines and power lines through the same conduit.
- To prevent damage by static electricity, wear a wrist strap or equivalent, and take measures to prevent charging, before touching terminal components or parts inside connectors.

■ Screw Locking Adhesive

- Screw locking adhesive (screw lock) may cause deterioration and cracking of resin parts; do not use it for screws in resin parts or anywhere where resin washers are used.

■ Cleaning

- Do not use organic solvents such as thinner or benzene.

■ Communications with the Host Device

Communicate with the host device only after confirming that the CIDRW Controller has started. Also, unstable signals may occur at the host interface when the CIDRW Controller is started. When initializing operation, clear the reception buffer at the host device or take other suitable methods to clear unwanted signals.

■ Startup Precaution

Never turn OFF the power supply while the CIDRW Controller is starting, including when power is turned ON, when the mode is changed, or when the CIDRW Controller is being reset. Doing so may damage the CIDRW Controller.

Editor's Note

Visual Aids



Indicates an explanation of a point that must be observed to ensure that the product is capable of its proper functions and performance. Read this information carefully and follow the cautions. If the product is used incorrectly, data or the equipment itself could be destroyed.



Indicates summaries of points of particular importance relating to product performance, e.g. points to note during operation and advice on how to use the product.



Indicates the number of a page where related information can be found.



Indicates information for reference when you encounter a problem.

Indicator Statuses

The following symbols are used to show the status of the indicators on the CIDRW Controller and Amplifier Units.

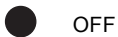

OFF



Flashing



ON

Table of Contents

Introduction	0
To Users of Model V700-L21	4
Applicable Standards	5
Applicable SEMI Standards	7
Precautions for Safe Use	8
Precautions for Correct Use	9
Editor's Note	11
SECTION 1 Product Outline	15
What is a CIDRW System?	16
Features	17
System Configuration	18
Component Names and Functions	19
Flowchart for Getting Started	23
SECTION 2 Installation and Connections/Wiring	25
Installation	26
Connections and Wiring	31
SECTION 3 Preparing for Communications	47
Set the Communications Conditions for the CIDRW Controller	48
Set the Communications Conditions for Amplifier Units	61
Set the Communications Conditions for Link Units	63
Communications Test	65
SECTION 4 Reading from/Writing to ID Tags	69
When SECS is Used	70
When SECS is Not Used	81

SECTION 5 Troubleshooting	91
When SECS is Used	92
When SECS is Not Used	98
SECTION 6 Appendix	103
Specifications and Dimensions	104
System Configuration Examples	108
Characteristic Data depending on Conditions of Use	110
Data Segment Area	129
Regular Inspection	130
SECS Protocol Specifications	131
ASCII Code Table	136
Protective Construction	137
Index	139
Revision History	141

MEMO

SECTION 1

Product Outline

❖ What is a CIDRW System?	16
❖ Features	17
❖ System Configuration	18
❖ Component Names and Functions	19
❖ Flowchart for Getting Started	23

What is a CIDRW System?

The CIDRW system writes data to, and reads data from, the carrier IDs (ID Tags) mounted on the carriers (FOUP) in semiconductor manufacturing processes without contacting these ID Tags. CIDRW is the abbreviation of Carrier ID Reader/Writer and this abbreviation is used throughout this manual.

Reading and writing information such as models, process instructions, lots, and inspection results to and from ID Tags makes it possible to manage work instruction information from a host device.

Example: Management of information in semiconductor and wafer manufacturing processes

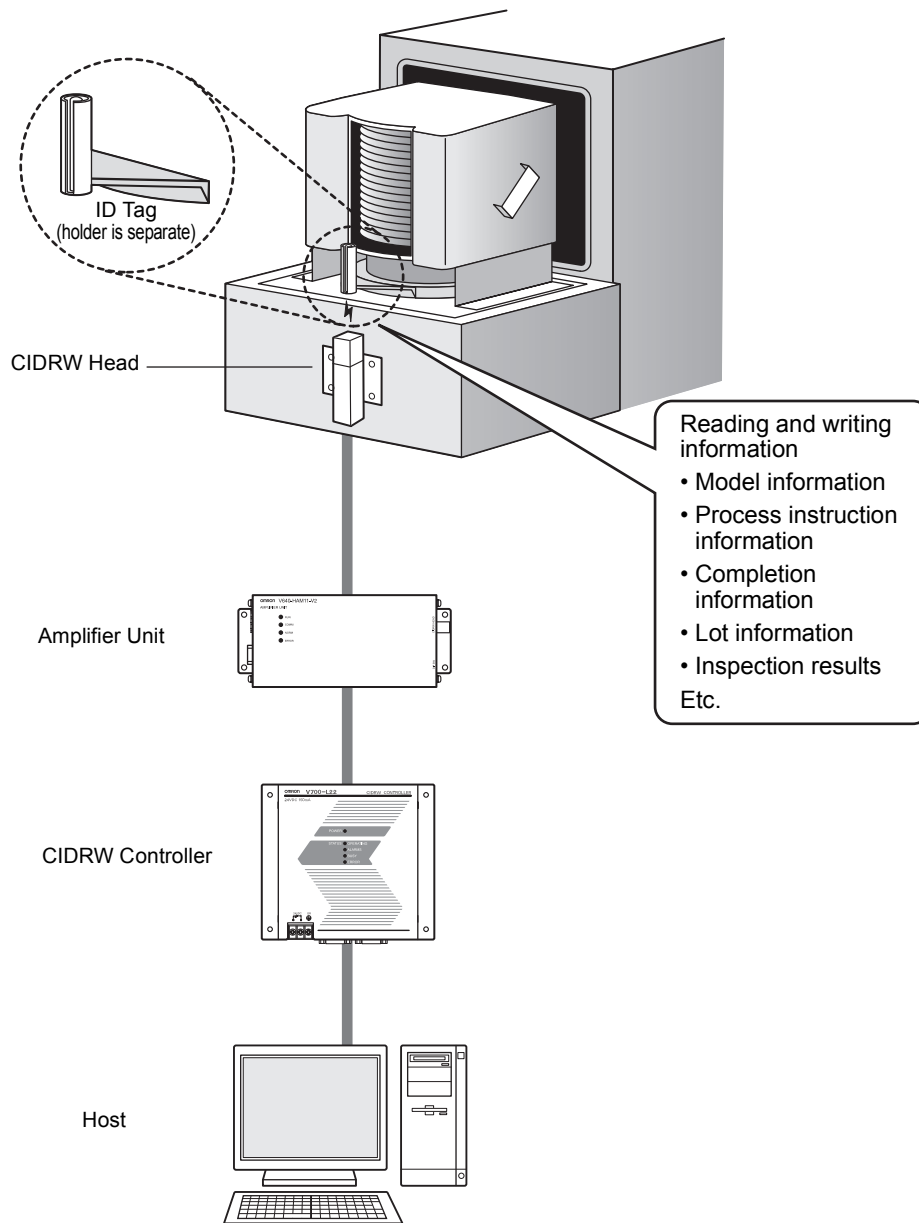

Features

■ CIDRW Systems that Conform to SEMI Standards (SEMI E99, E5, E4)

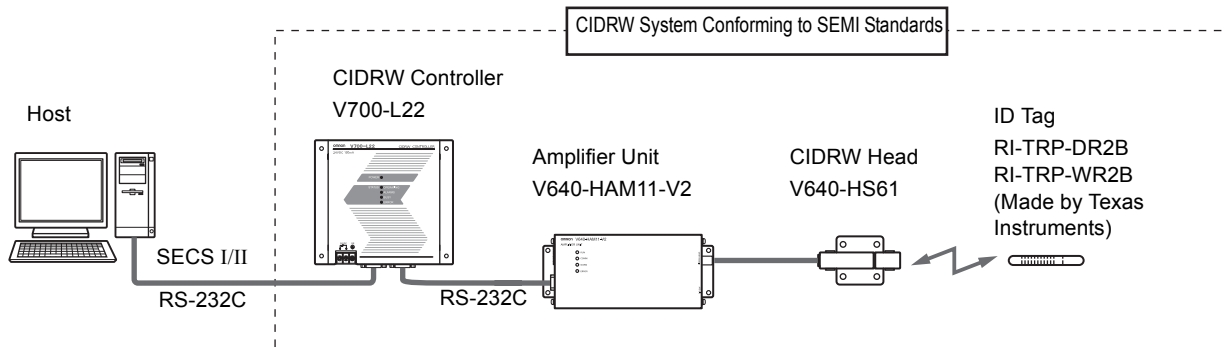

List of Applicable Standards

- SEMI E99 THE CARRIER ID READER/WRITER FUNCTIONAL STANDARD
- SEMI E5 EQUIPMENT COMMUNICATION STANDARD 2 MESSAGE CONTENT (SECS II)
- SEMI E4 EQUIPMENT COMMUNICATION STANDARD 1 MESSAGE TRANSFER (SECS I)



SEMI is the acronym for Semiconductor Equipment and Materials International.
SECS is the acronym for SEMI Equipment Communications Standard.

The V640-HAM11-V2 automatically distinguishes the type of Texas Instruments ID Tag being used (RI-TRP-DR2B/-WR2B), and reads and writes the data from the ID Tag.

System Configuration

When SECS Is Used

Communication with the host device is possible using the SECS protocol.

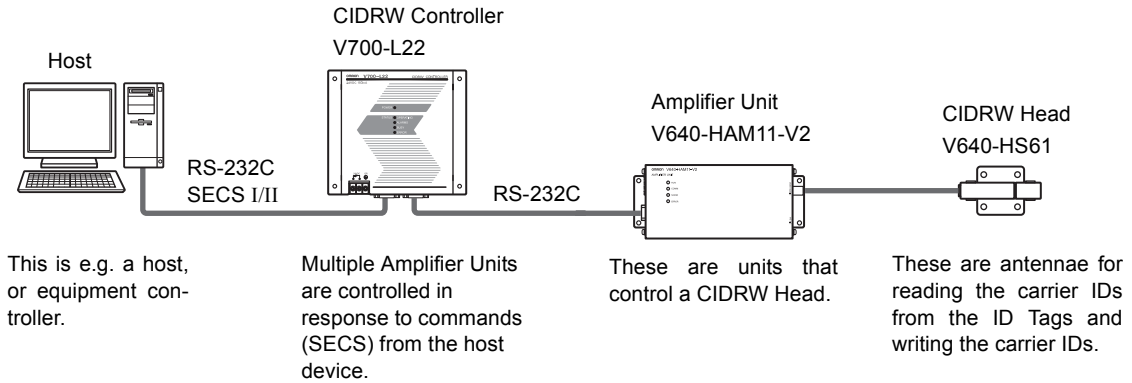

When SECS Is Not Used

Communications with the host device follow the OMRON proprietary protocol. The Amplifier Units are connected directly to the host device without using a CIDRW Controller.

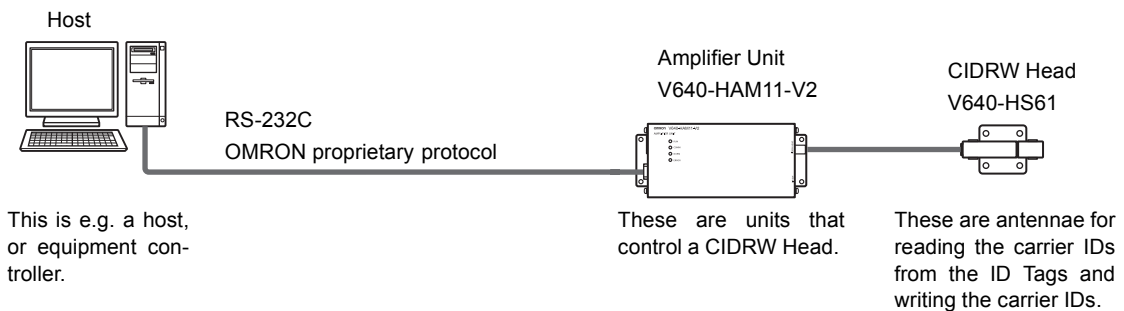

Refer to the following page for specific connection examples.

page 108

CHECK!

Using Link Units (V700-L11) to make connections makes it possible to remove and replace just the relevant Amplifier Unit while leaving the power to the CIDRW system on in the event of a failure or during maintenance.

Component Names and Functions

CIDRW Controller V700-L22

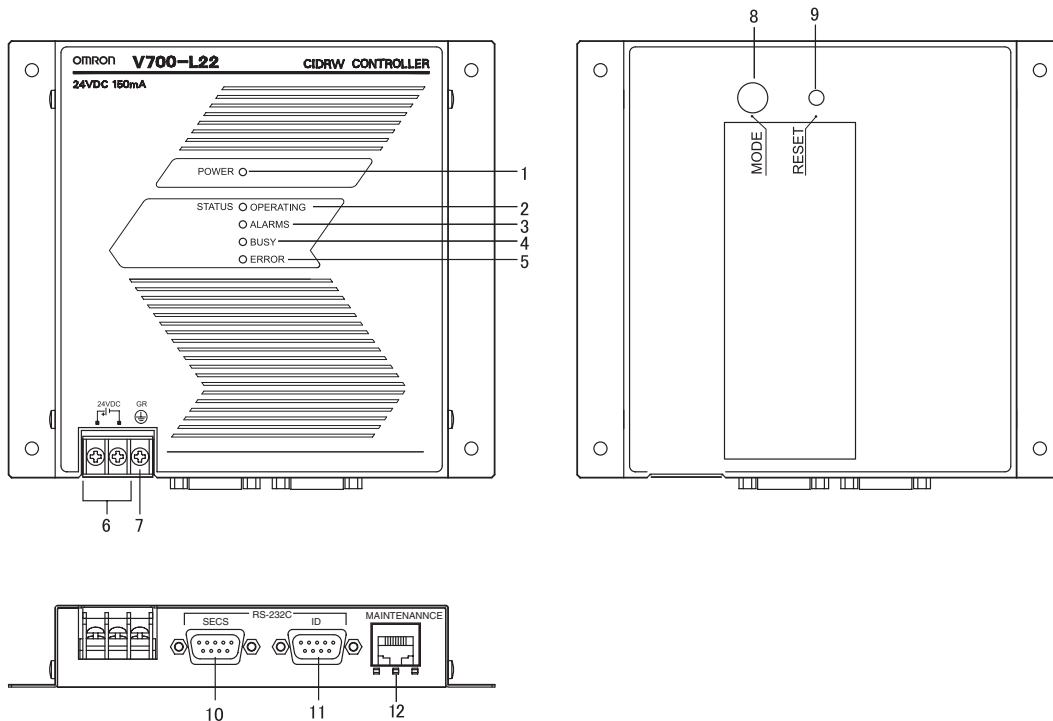

No.	Name	Function
1	Power indicator (green)	An LED that indicates whether the power is ON or OFF. Lit while the power is ON.
2	OPERATING indicator (green)	Lit while the CIDRW system status model is operating.
3	ALARMS indicator (green)	Lit when the status in "Alarm Status" of the CIDRW system is Alarm (1).
4	BUSY indicator (green)	Lit when the status in "Operational Status" of the CIDRW system is BUSY.
5	ERROR indicator (red)	When a processing error is detected (when SSACK is other than NO), this indicator is lit for 50 ms.
6	24 VDC power supply terminals (with cover)	Connect to the 24 VDC power supply.
7	Frame ground terminal (with cover)	The grounding wire is connected here. (Ground to 100 Ω or less)
8	MODE switch	Used to select the mode of operation.  Refer to page 48. 0: Normal Operation mode. When mounting the Controller, set the switch to this position. 3: Setting mode, selected to set information such as the communication conditions. When the switch on the bottom face of the Controller cannot be accessed, the operation mode can be changed from the host device while the switch is left at the 0 setting. 1 - 2, 4 - 7: Setting prohibited
9	RESET switch	Restarts the CIDRW Controller.
10	SECS port	Port for connecting the host device. Conforms to SECS I/II.
11	ID port	An Amplifier Unit or Link Unit is connected here.
12	Maintenance port (with cover)	Not used. Do not remove the cover.

Amplifier Unit V640-HAM11-V2

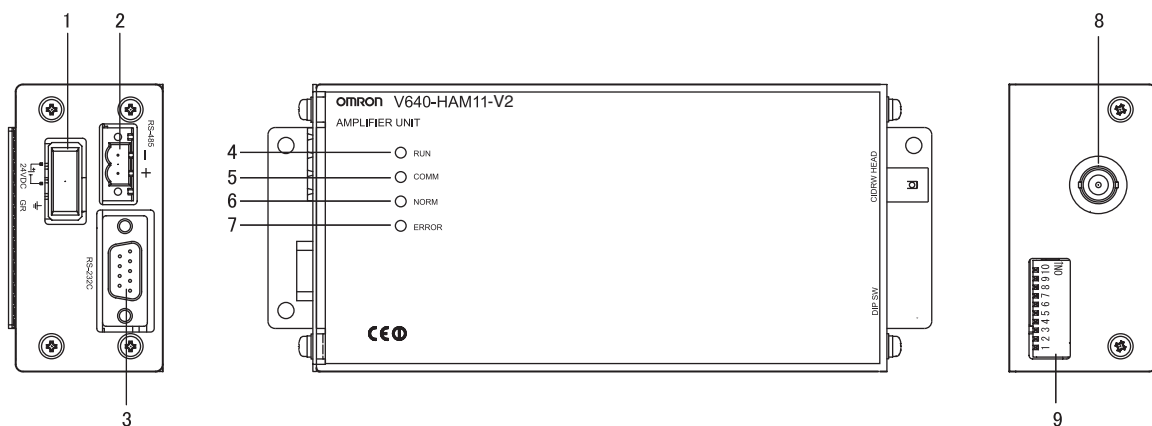

No.	Name	Function
1	Dedicated power supply connector	Connect to the 24 VDC power supply.
2	RS-485 port	When using multiple CIDRW Heads, connect this to the RS-485 port of another Amplifier Unit or to the multi-connection port of a Link Unit.
3	RS-232C port	Connected to a CIDRW Controller or a host device. Uses the OMRON proprietary communications protocol.
4	RUN indicator (green)	Turns ON when the Amplifier Unit is in normal operation.
5	COMM indicator (yellow)	Turns ON during communications with the host device or during communications with an ID Tag.
6	NORM indicator (green)	Turns ON when the communications finish with no error.
7	ERROR indicator (red)	Turns ON when an error occurs during communication with the host device, or during communication with an ID Tag.
8	CIDRW Head connection port	A CIDRW Head is connected here.
9	Setting DIP switches	Used to set the node number, the communications conditions, and the RS-485 terminal resistance.

CIDRW Head V640-HS61

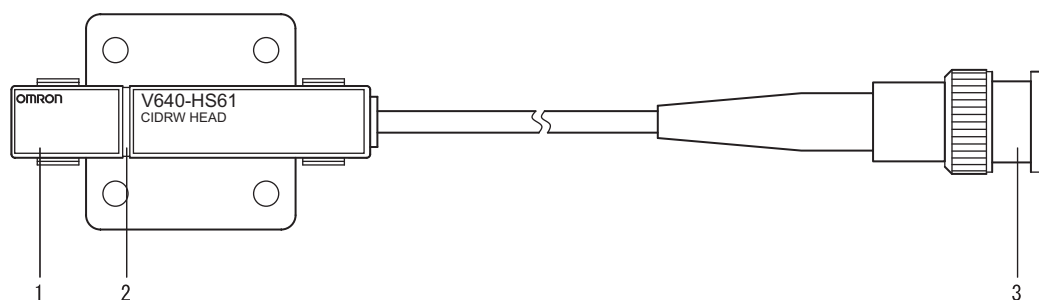

No.	Name	Function
1	Antenna	Used to communicate with ID Tags.
2	Antenna center	This is the center of the communications area.
3	Connector	Connect to an Amplifier Unit.

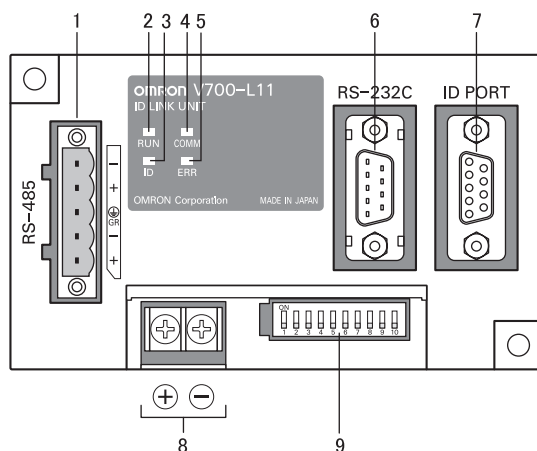

Link Unit V700-L11



No.	Name	Function
1	Multi-connection port (RS-485)	This is the port that connects to the Amplifier Units when multiple CIDRW Heads are connected to a CIDRW Controller. The GR (frame ground) terminal is also at this port.
2	RUN indicator (green)	Turns ON while the Link Unit is in normal operation.
3	ID indicator (green)	Not used
4	COMM indicator (green)	Turns ON during data communications with the host device.
5	ERR indicator (red)	Turns ON when an error occurs during data communications with the host device or head.
6	Host device connection port (RS-232C)	This is a port for connecting to the CIDRW Controller via an RS-232C interface. A dust cover is fitted on shipment from the factory. Remove this cover before using the port.
7	ID connection port	Not used
8	24 V power supply terminals (inside the cover)	Connect to the 24 VDC power supply.
9	Setting DIP switches (inside the cover)	Used to set the equipment number, the communications conditions, and the RS-485 terminal resistance.



Flowchart for Getting Started

Installation and Connections

-  Installation
Refer to page 26.
-  Connection and Wiring
Refer to page 31.





Preparation for Communications

-  Set the Communications Conditions for the CIDRW Controller
Refer to page 48.
-  Set the Communications Conditions for Amplifier Units
Refer to page 61.
-  Set the Communications Conditions for Link Units
Refer to page 63.



Trial Operation

-  Test for Communications with the Host Device
Refer to page 65.
-  ID Tag <-> CIDRW System Communications Test
Refer to page 66.
-  Check the Surrounding Environment
Refer to page 28.







Communications

 When SECS is Used
Refer to page 70.



 When SECS is Not Used
Refer to page 81.

When you Encounter a Problem...

 When SECS is Used

-  Refer to page 92. List of Error Messages
-  Refer to page 92. Controller Indicators
-  Refer to page 93. Operation Check Flowchart

 When SECS is Not Used

-  Refer to page 98. List of Error Messages
-  Refer to page 98. Amplifier Unit Indicators
-  Refer to page 99. Operation Check Flowchart

SECTION 2

Installation and Connections/Wiring

☒ Installation	26
☒ Connections and Wiring	31

Installation

CIDRW Controller

NOTICE

There is a switch for selecting the operation mode (Normal Operation mode <-> Setting mode) on the bottom face of the CIDRW Controller. Set the communications conditions in the Setting mode (switch position 3) before mounting the CIDRW Controller.



Refer to page 48.

Set the Controller to the Normal Operation mode (switch position 0) when mounting it.

Mount the CIDRW Controller with the resin washers and four M4 screws provided as accessories.

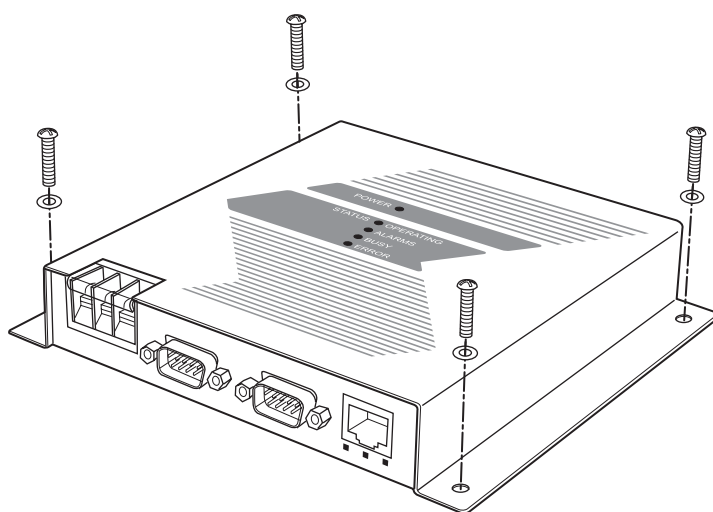

Mounting dimensions

(Unit: mm)

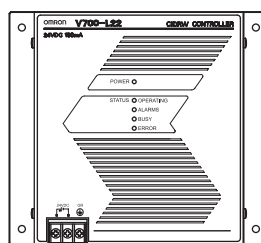
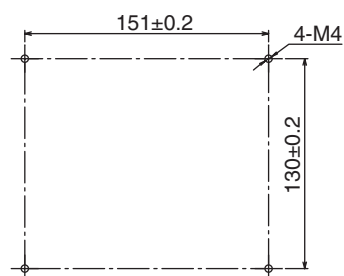

NOTICE

- Tighten the M4 screws with a torque not exceeding 1.2 N·m.
- Do not apply organic solvents used with screw locking agents at the locations where the screws are inserted.

Amplifier Unit

Use spring washers and flat washers with the four M4 screws when mounting the Amplifier Unit.

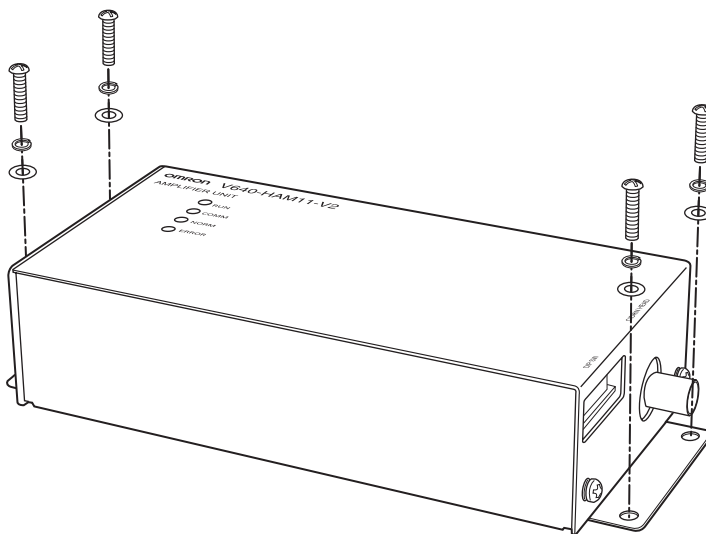

Mounting dimensions

(Unit: mm)

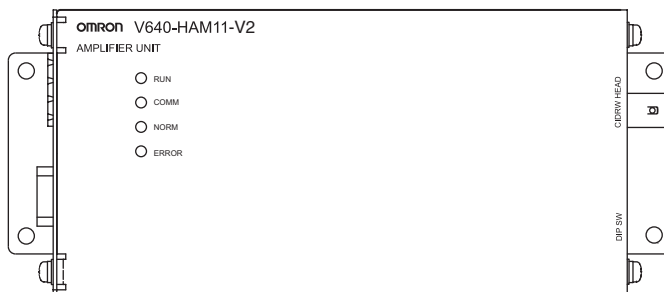
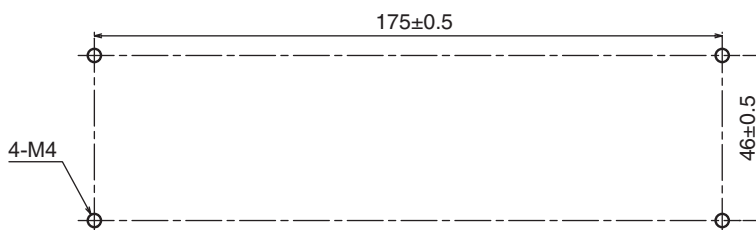

NOTICE

Tighten the M4 screws with a torque not exceeding 1.2 N·m.

CIDRW Head

The area for communications with ID Tags varies substantially according to the installation orientations and the background conditions (metals, noise, etc.). Check the communications area before deciding the installation position.

For details on actual communications distances, see *Characteristic Data depending on Conditions of Use* in *Appendix*.



Refer to page 109.

Positional Relationship between the CIDRW Head and the ID Tag

The communications area differs according to the positional relationship during communications.

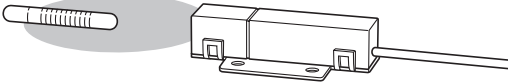
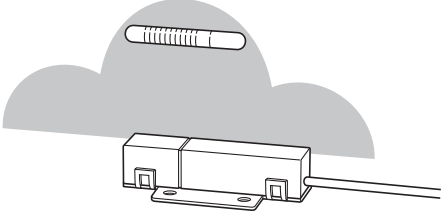
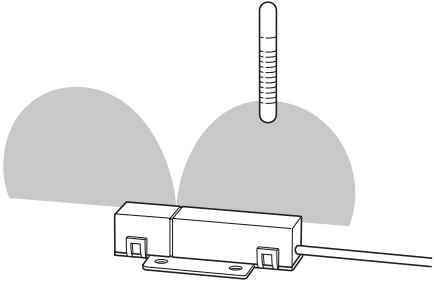
Mounting orientation	Communications area (purely illustrative)	Explanation
Coaxial		The maximum communications area is obtained when the center lines of the CIDRW Head and the ID Tag coincide.
Parallel		The maximum communications area is obtained when the center point of the antenna on the CIDRW Controller is aligned with the center line of the ID Tag.
Vertical		When the center point of the antenna on the CIDRW Head is aligned with the center line of the ID Tag, the communications area is substantially reduced.

Data Reading and Writing

The communications distances for reading and writing are not the same; the distance is shorter for writing. Therefore, when data is to be both read and written, take the distance for writing as the reference distance when installing the CIDRW Head and the ID Tag.

■ Influence of Background Metal on ID Tag

Metals in the vicinity of the communications area will affect the range, making it smaller.

 Refer to page 115.

■ Influence of Noise

This CIDRW system uses a frequency of 134 kHz for communications with ID Tags. Equipment such as switching power supplies, inverters, servomotors, or monitors in the surrounding area will adversely affect communications, restricting the communications area.



The noise levels in the vicinity of the CIDRW Head can be determined with the environmental noise measurement command (applies only when SECS is not used) . Refer to page 89.

For details on the relationship between noise and communications distance, see *Appendix* . Refer to page 128.

■ Mounting

Use spring washers and flat washers with the four M3 screws when mounting a CIDRW Head.

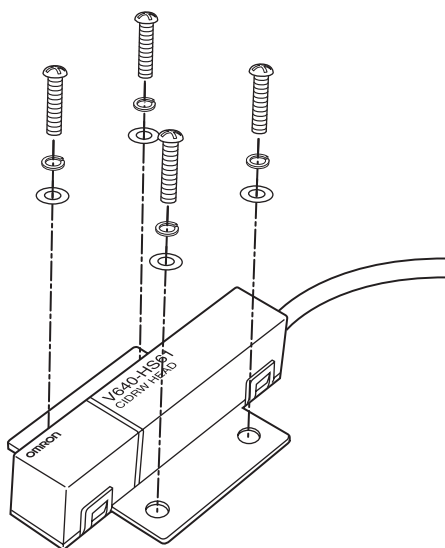

Mounting dimensions

(Unit: mm)

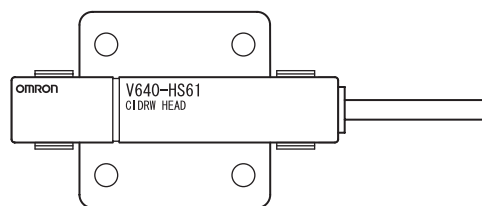
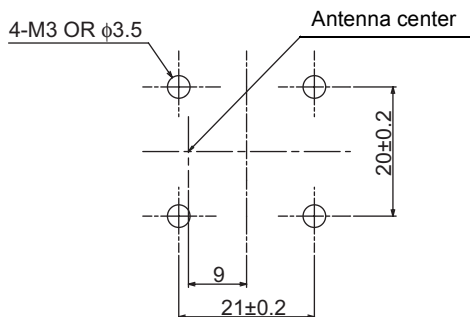

NOTICE

Tighten the M3 screws with a torque not exceeding 0.6 N·m.

Link Unit

Mount Link Units with the two M4 screws and washers provided as accessories.

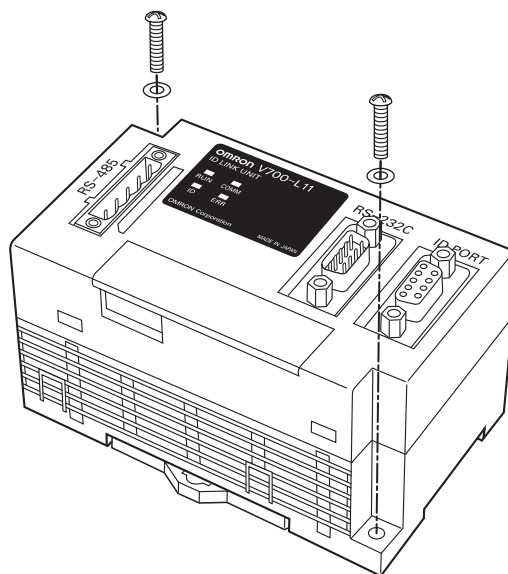

Mounting dimensions

(Unit: mm)

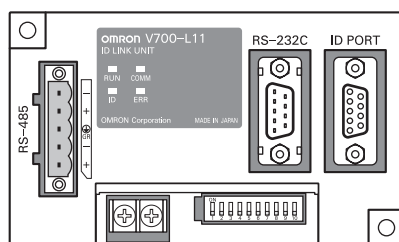
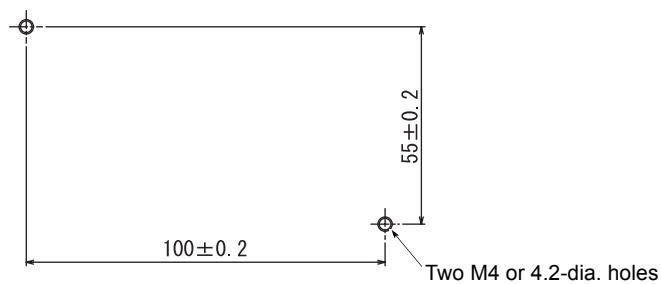

NOTICE

- Tighten the M4 screws with a torque not exceeding 1.2 N·m.
- Do not apply organic solvents used with screw locking agents at the locations where the screws are inserted.

Connections and Wiring

CIDRW Controller

Power Supply and Grounding Wires

Connect the wires to the 24 VDC power supply terminals and frame ground terminal.

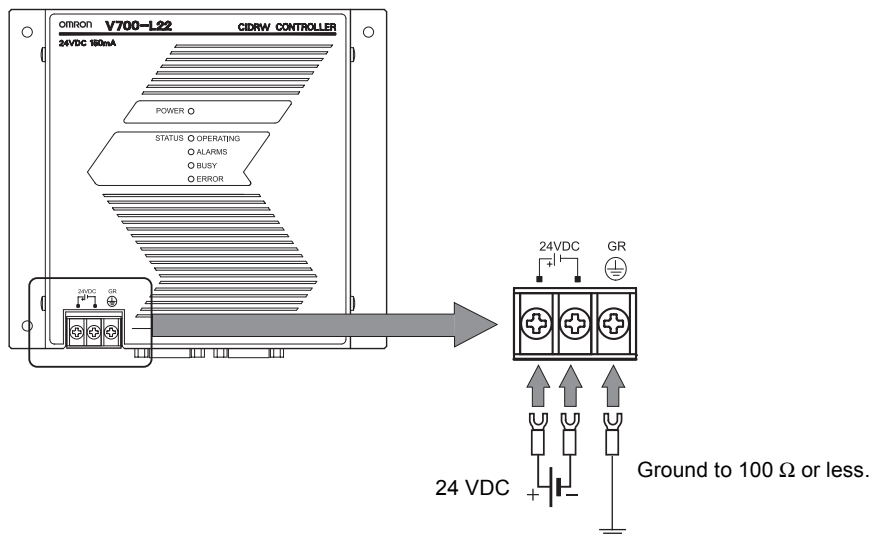

- Crimp terminals

The terminal screws on the terminal block are M3 size. Use appropriate crimp terminals for M3 screws as shown below.

Crimp terminals

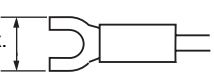
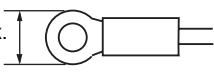
Shape	Size
Forked	6 mm max. 
Round	6 mm max. 

- Power supply

Use a power supply unit that satisfies the following conditions.

Condition

Power supply voltage	Output current	Safety standard
24 VDC +10%, -15%	500 mA DC min.	UL Class 2

Recommended model

Manufacturer	Model
OMRON	S82K-01524

NOTICE

Be sure to replace the cover after wiring.

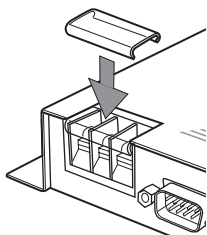

■ **SECS port**

The method for wiring for communications with a host device via the SECS port is explained here.

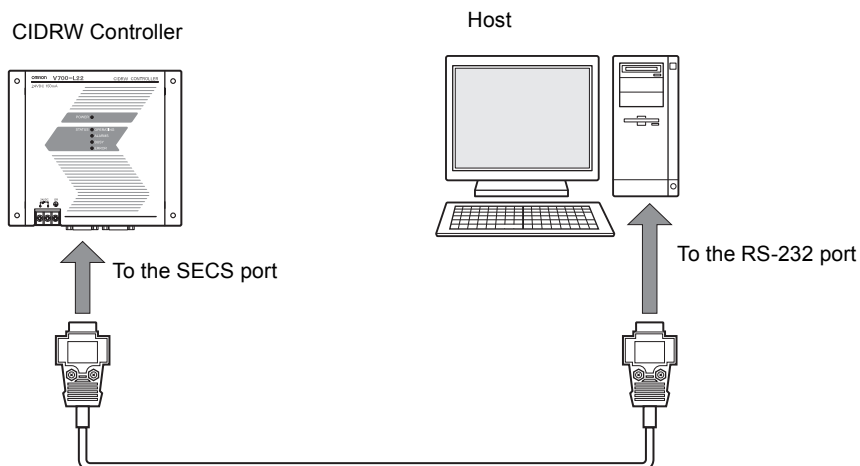

• **Connector**

The SECS port on the Controller is a D-SUB 9-pin connector. The pin arrangement is shown below.

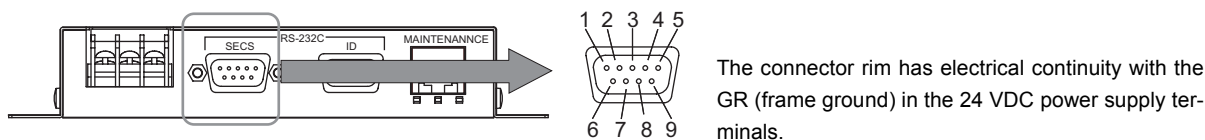

Pin No.	Signal name	Symbol	Signal direction	Remarks
1	—	NC	—	Not connected
2	Receive data	RD	Input	
3	Send data	SD	Output	
4	—	—	Output	Always OFF
5	Signal ground	SG	—	
6	—	—	Input	Use in the open status.
7	Request send	RS	Input	Always ON during normal operation
8	—	NC	—	Not connected
9	—	NC	—	Not connected

Recommended model

		Manufacturer	Model
Cable		Hitachi Cable	CO-MA-VV-SB 5PX28AWG
Connector	Socket	OMRON	XM2D-0901
	Hood		XM2S-0913

• Wiring

The cable length should be no greater than 15 m.

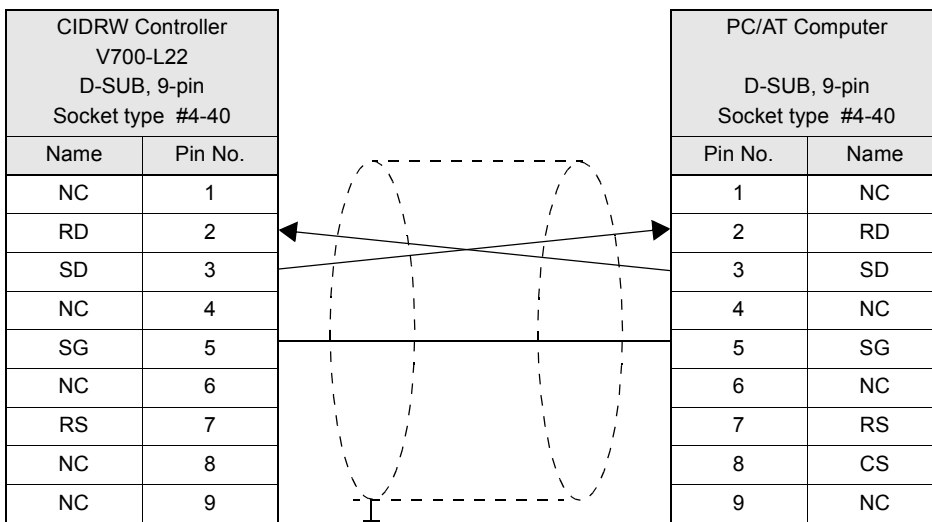

Ground shielded wires either at the CIDRW Controller side or at the PC/AT side.

Amplifier Unit

■ Connector for connecting a CIDRW Head

1. Align the pin on the connector with the channel in the cable connector and insert the cable connector.
Hold the fixed part of the connector while making this insertion.

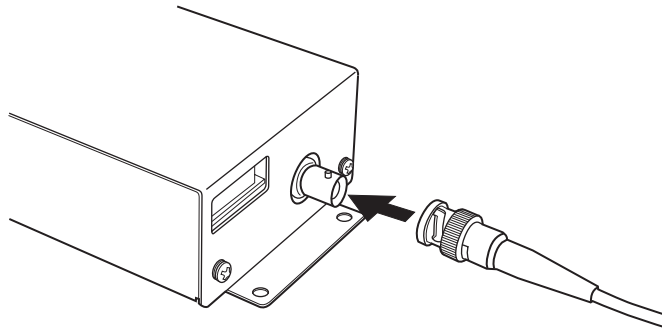

2. After inserting the connector fully home, turn the fixed part clockwise to lock it.

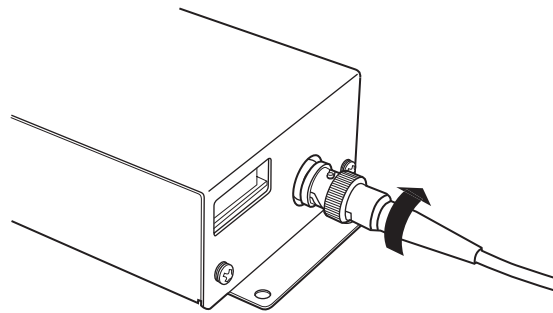

■ Power Supply and Grounding Wires

Connect the power supply and grounding wires to the dedicated power supply connector.

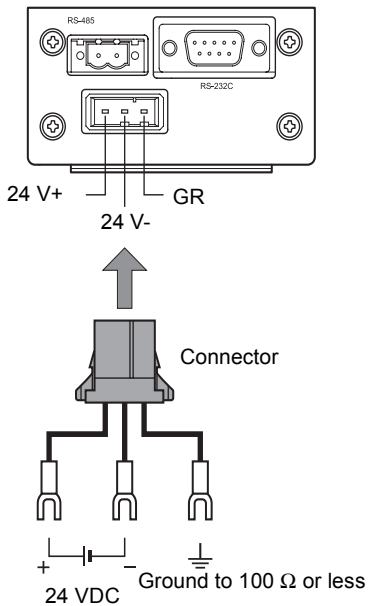

NOTICE

- The grounding wire should be connected to a ground exclusive to the Amplifier Unit. If the grounding wire is shared with another unit, or connected to a beam in a building, there may be adverse effects.
- Make the grounding point as close as possible and the length of the grounding wire used as short as possible.

- Dedicated power supply connector and RS-485 port connector
Prepare a V640-A90 (can be purchased as an accessory).

Contents of the V640-A90 set (accessory)

Name	Quantity	When procured individually	
		Manufacturer	Model
Power supply connector	One	Tyco Electronics	1-178288-3
Pins for power supply connector	Three		175217-3
Connector for RS-485 port	One	Phoenix Contact	MSTB2.5/2-STF-5.08

- Dedicated power supply cable
Use an AWG20 - 24 cable.
Use a dedicated tool for crimping the cable to the connector pins.

Recommended crimping tool

Manufacturer	Model
Tyco Electronics	919601-1

- Power supply unit
Use a power supply unit that satisfies the following conditions.

Condition

Power supply voltage	Output current	Safety standard
24 VDC +10%, -15%	300 mA DC min.	UL Class 2

Recommended product

Manufacturer	Model
OMRON	S82K-01524

■ RS-232C Port

The method for connecting a CIDRW Controller or host device via the RS-232C port is explained here.

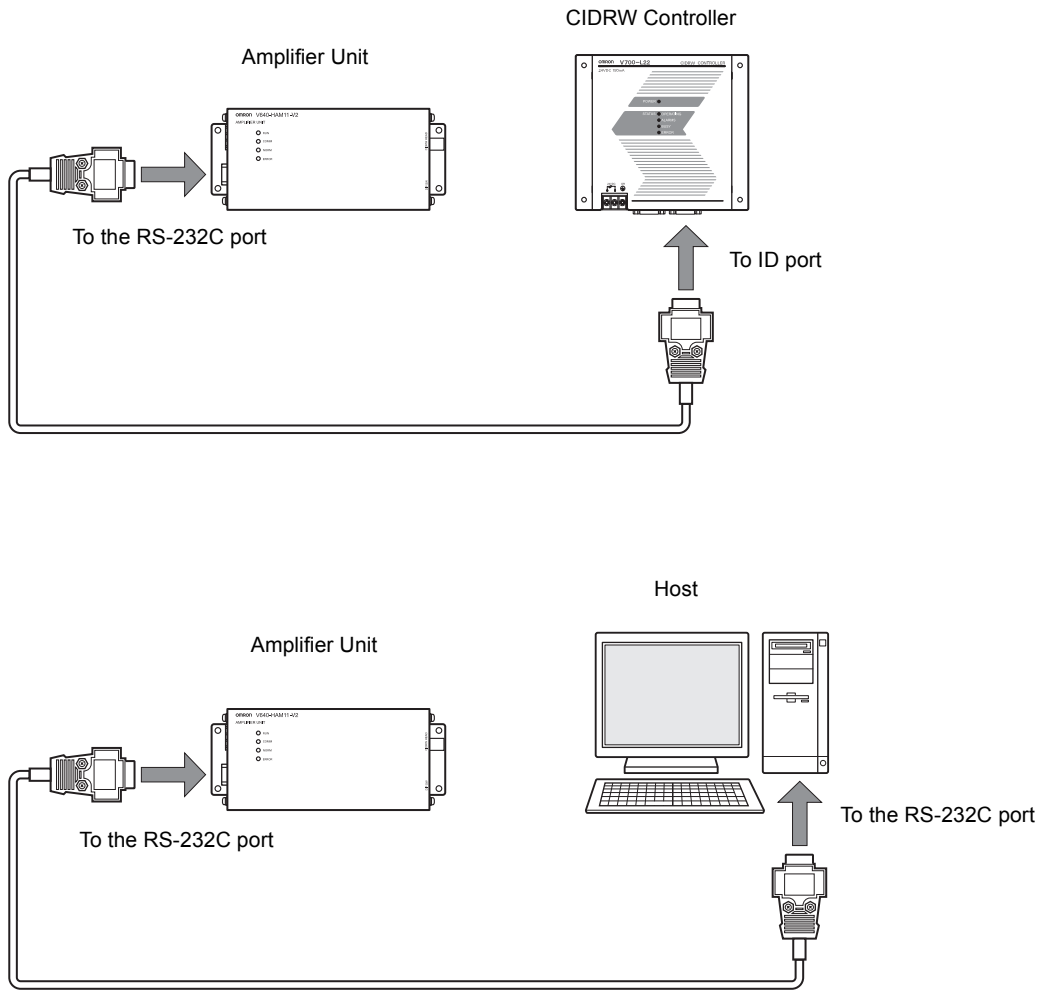

• Connector

The RS-232C port of the Amplifier Unit is a D-SUB, 9-pin connector. The pin arrangement is shown below.

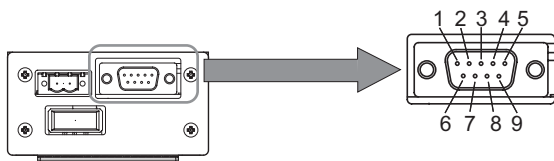

The connector rim has electrical continuity with the GR (frame ground) terminal in the dedicated power supply connector.

Pin No.	Signal name	Symbol	Signal direction	Remarks
1	—	NC	—	Not connected
2	Receive data	RD	Input	
3	Send data	SD	Output	
4	—	NC	—	Not connected
5	Signal ground	SG	—	
6	—	NC	—	Not connected
7	Request send	RS	Output	Always ON during normal operation
8	Send enable	CS	Input	
9	—	NC	—	Not connected

Recommended model

			Manufacturer	Model
Cable			Hitachi Cable	CO-MA-VV-SB 5PX28AWG
Connector	Host side	Socket	OMRON	XM2D-0901
		Hood		XM2S-0913
	Amplifier unit side	Socket		XM2D-0901
		Hood		XM2S-0911

- Wiring for connection to a V700-L22 CIDRW Controller
The cable length should be no greater than 15 m.

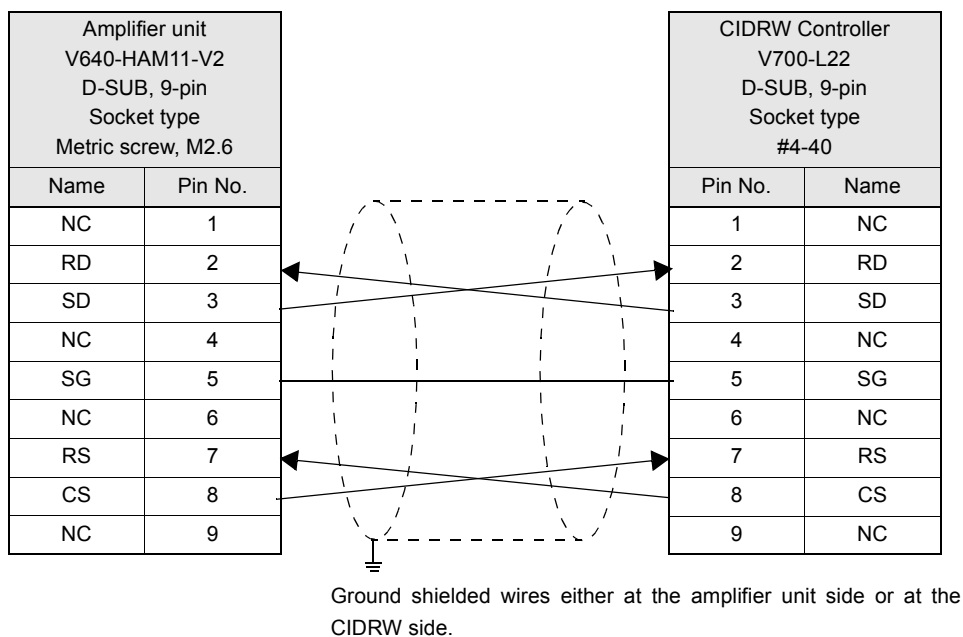

- Wiring for connection to a PC/AT computer (9-pin connector specification)
 The cable length should be no greater than 15 m.

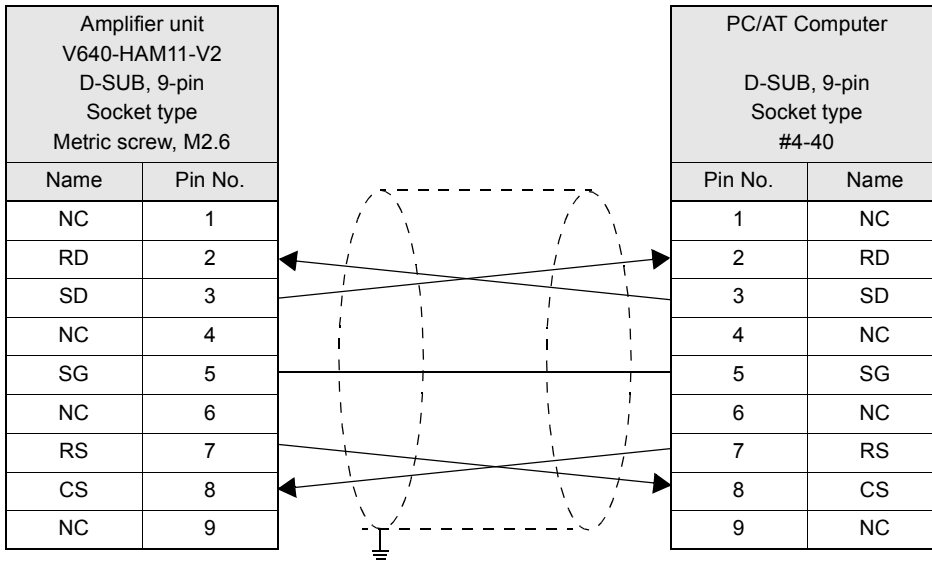

Ground shielded wires either at the CIDRW Controller side or at the PC/AT side.

If the CS function is to be used at the PC/AT computer side, a return wire is required.

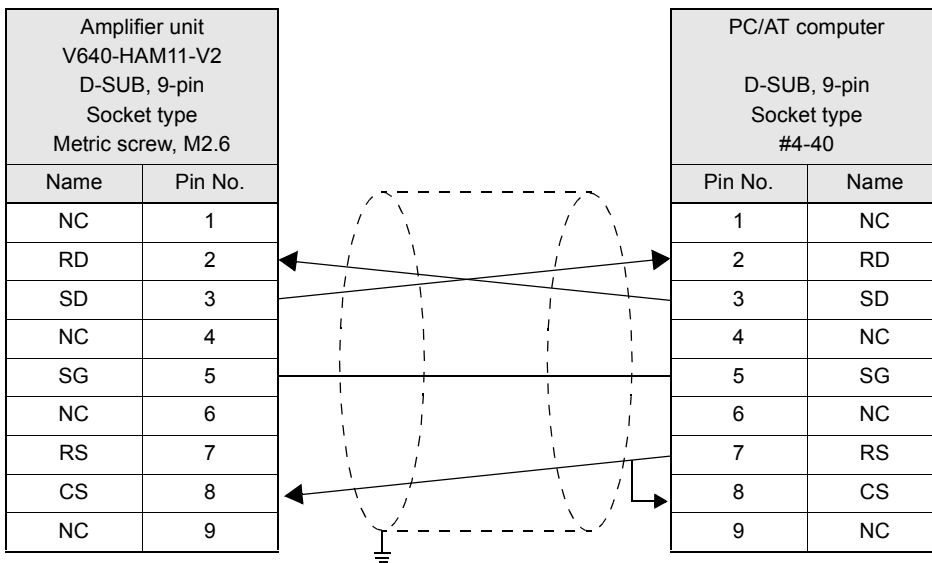

Ground shielded wires either at the CIDRW Controller side or at the PC/AT side.



RS signal control method at the host device

In a 1:N connection, the RS signals generated from the host device by normal control must be input as CS signals. Turn the RS signals OFF within 15 ms after the completion of data transmission. Correct communications will not be possible without this control.

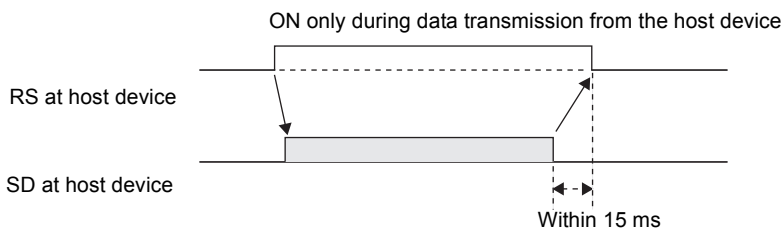

■ RS-485 Port

The method for connection to the RS-485 port of another Amplifier Unit when multiple CIDRW Heads are used is explained here.

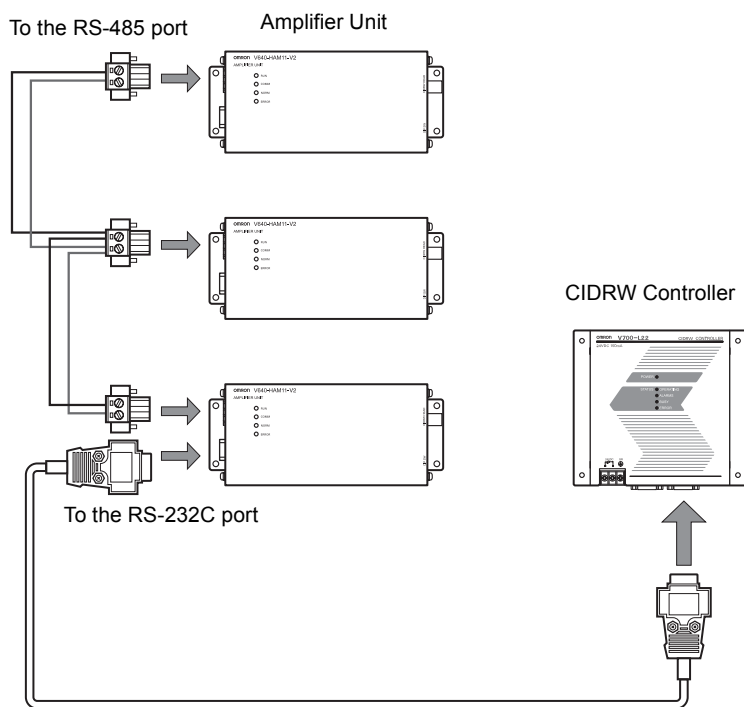

NOTICE The maximum total length of RS-485 cable is 50 m.

• Connector

Prepare a V640-A90 (can be purchased as an accessory) as the connector for the RS-485 port on the Amplifier Unit.

Refer to page 35.

The pin arrangement is shown below.

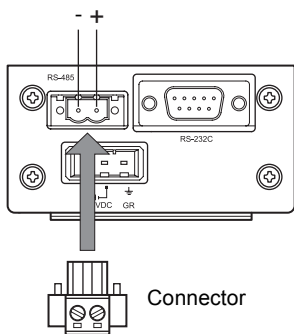

Name	Function
-	Connect to the minus line of another Amplifier Unit.
+	Connect to the plus line of another Amplifier Unit.

• Cable information

Recommended model

		Manufacturer	Model
Cable	RS-485 signal wire	Tachii Electric Wire	MVVS 2CX0.5SQ
Crimp terminals	When one wire is connected to each terminal.	Phoenix Contact	AI0.5-8WH
	When two wires are connected to each terminal.		AI-TWIN2×0.5-8WH
Crimping tool			CRIMPFOX UD6

• Wiring method

1. Attach crimp terminals to stripped portions of the cables.
2. Insert the wires into the correct holes in the connector, bearing the orientation of the connector in mind.
3. Tighten the set screws of the connector firmly to secure the cables.

The appropriate tightening torque is around 0.5 N·m.



CHECK!

A standard, tapered screwdriver will not enter all the way into the screw holes. Use a small gauge flat-blade screwdriver whose shaft and tip have the same thickness.

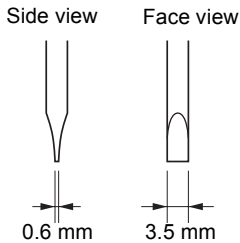

Recommended screwdriver

Manufacturer	Model
OMRON	XW4Z-00C

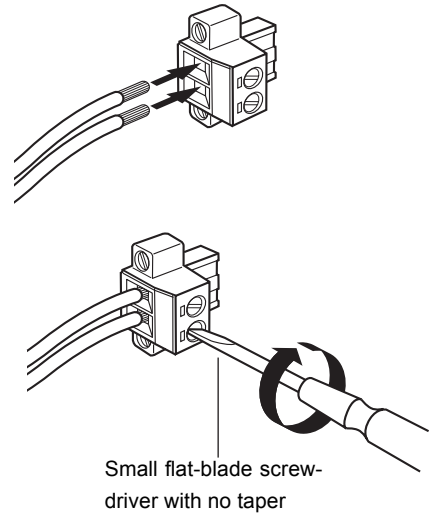

4. Having fitted the connector to the cable, connect it to an Amplifier Unit.

Orient the cable connector correctly in relation to the connector on the Amplifier Unit, and fasten the cable connector by fully tightening the retaining screws.

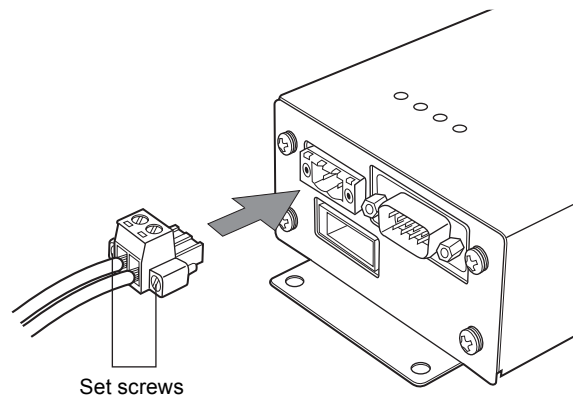

CHECK!

Disconnecting the connector

Fully loosen the two screws, then grip the projections on the connector and pull it straight out. If it is difficult to pull the connector out, press down on the Amplifier Unit while pulling on the connector.

Link Unit

■ Power Supply

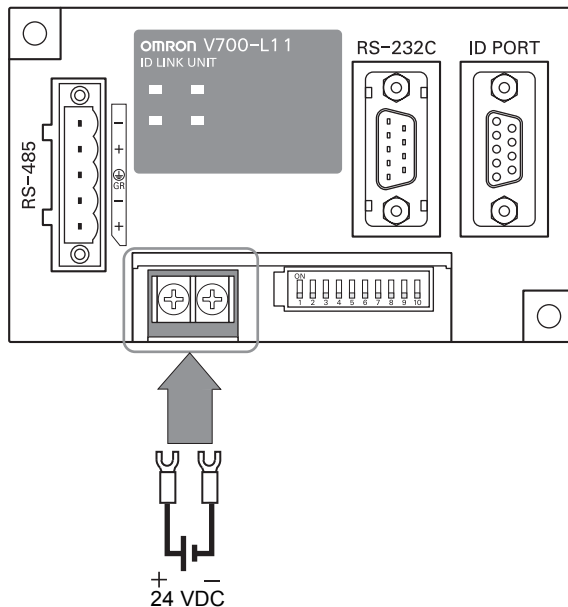

Opening the cover on the top face of the Link Unit exposes the power supply terminals.



• Crimp terminals

The terminal screws on the terminal block are M3 size. Use appropriate crimp terminals for M3 screws as shown below.

Crimp terminals

Shape	Size
Forked	6 mm max. 
Round	6 mm max. 

• Power supply

Use a power supply unit that satisfies the following conditions.

Condition

Power supply voltage	Output current	Safety standard
24 VDC +10%, -15%	500 mA DC min.	UL Class 2

Recommended model

Manufacturer	Model
OMRON	S82K-01524

■ **Host Connection Port**

The method for connecting to a CIDRW Controller or host device via the RS-232C port is explained here.

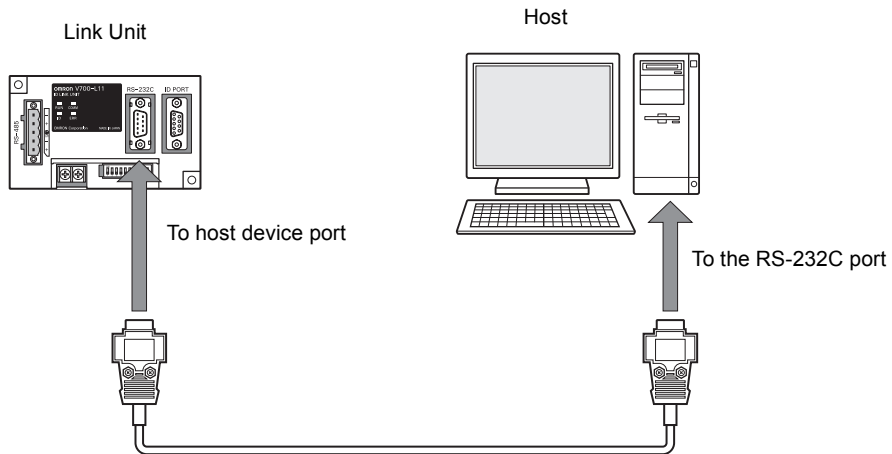
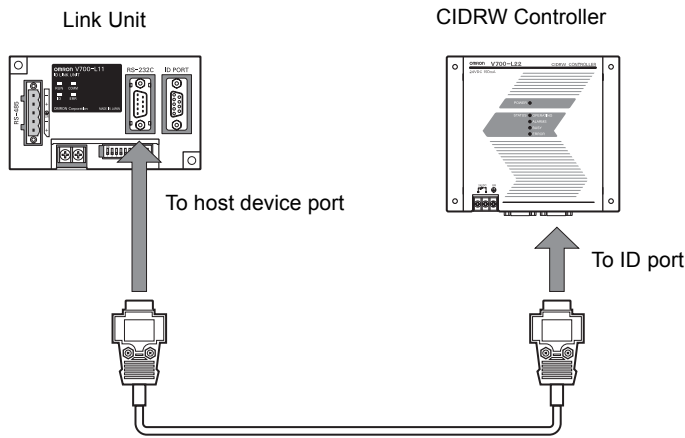

• **Connector**

The host device connection port on the Link Unit is a D-SUB, 9-pin connector. The pin arrangement is shown below.

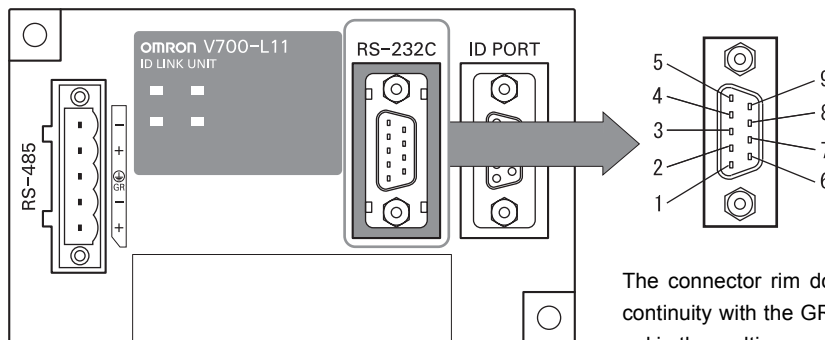

The connector rim does not have electrical continuity with the GR (frame ground) terminal in the multi-connection port.

Pin No.	Signal name	Symbol	Signal direction	Remarks
1	—	NC	—	Not connected
2	Receive data	RD	Input	
3	Send data	SD	Output	
4	—	NC	—	Not connected
5	Signal ground	SG	—	
6	—	NC	—	Not connected
7	Request send	RS	Output	Always ON during normal operation
8	Send enabled	CS	Input	
9	—	NC	—	Not connected

Recommended model

		Manufacturer	Model
Cable		Hitachi Cable	CO-MA-VV-SB 5PX28AWG
Connector	Socket	OMRON	XM2D-0901
	Hood		XM2S-0913

• Wiring for connection to a CIDRW Controller

The cable length should be no greater than 15 m.

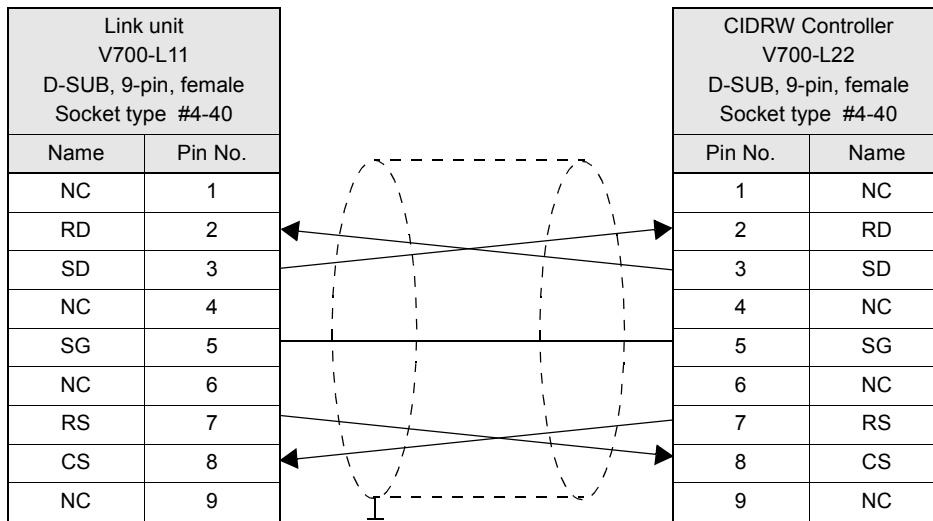

Ground shielded wires at the CIDRW Controller side.

- Wiring for connection to a PC/AT computer

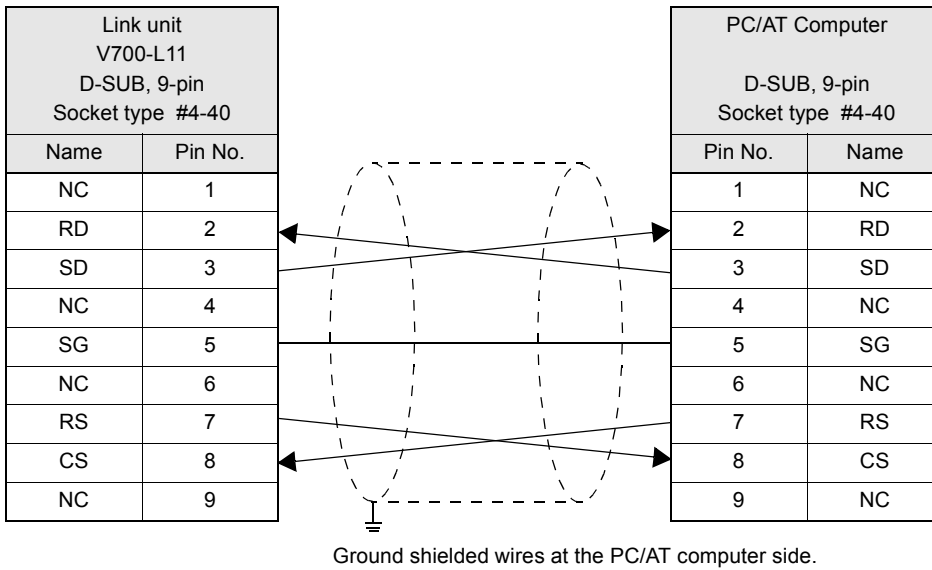

Ground shielded wires at the PC/AT computer side.

If the CS function is to be used at the PC/AT computer side, a return wire is required.

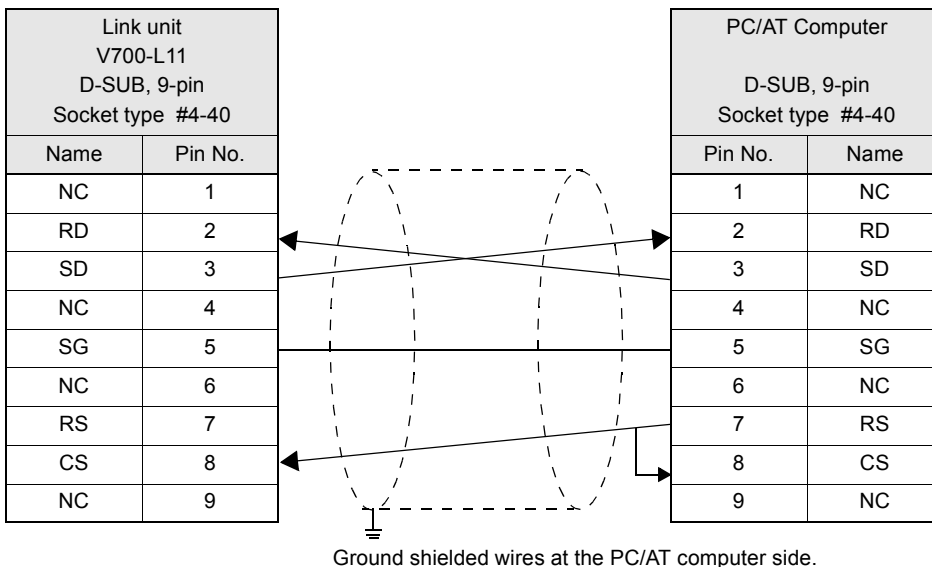

Ground shielded wires at the PC/AT computer side.



RS signal control method at the host device

In a 1:N system using Link Units, the RS signals generated from the host device by normal control must be input as CS signals. Turn the RS signals OFF within 15 ms after the completion of data transmission. Correct communications will not be possible without this control.

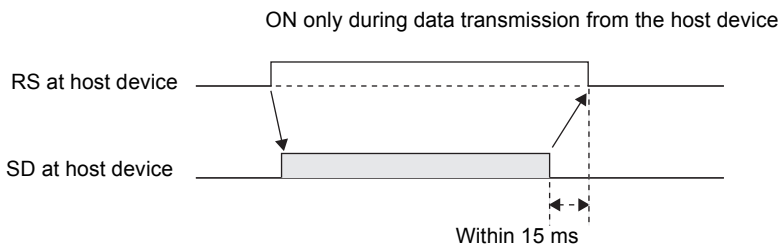

Multi-connection port

The method for connecting to an Amplifier Unit is explained here.

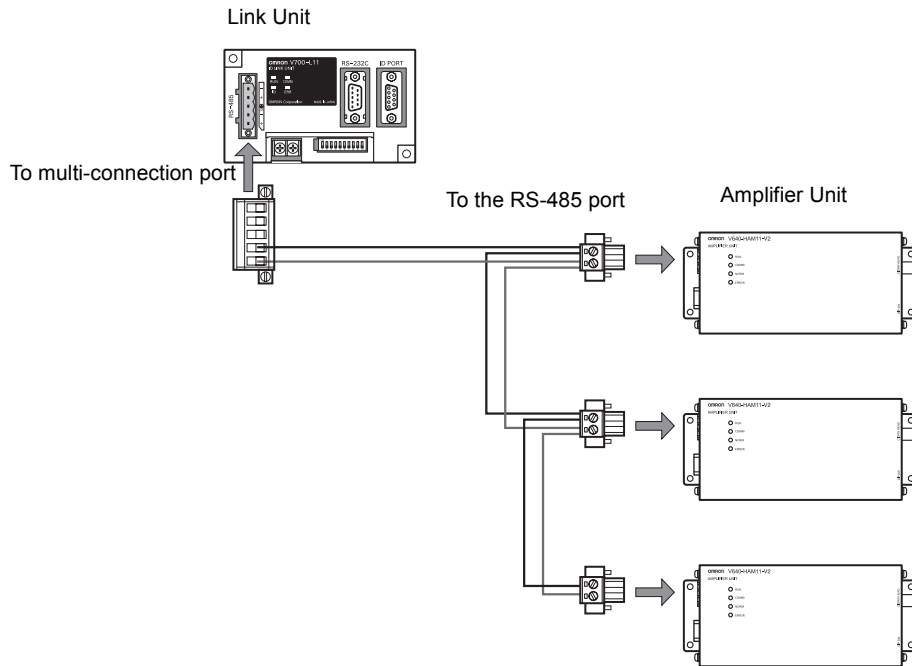

• Connector

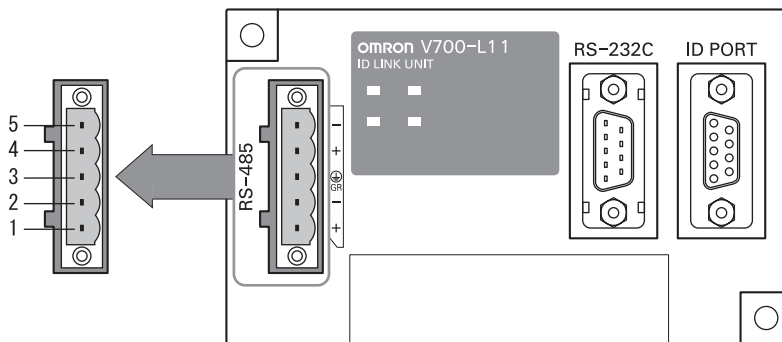

Pin No.	Name	Function
5	-	No wiring is required. (Short with terminal 2 within the circuit)
4	+	No wiring is required. (Short with terminal 1 within the circuit)
3	GR	Ground to 100 Ω or less.
2	-	Connect to the minus line of the Amplifier Unit.
1	+	Connect to the plus line of the Amplifier Unit.

• Cable

Recommended Product

		Manufacturer	Model
Cable	RS-485 signal wire	Tachii Electric Wire	MVVS 2CX0.5SQ
	Frame ground line	AWG22 - 20 cable	
Crimp terminals	When one wire is connected to each terminal.	Phoenix Contact	AI0.5-8WH
	When two wires are connected to each terminal.		AI-TWIN2×0.5-8WH
Crimping tool			CRIMPFOX UD6

• Wiring method

1. Attach crimp terminals to stripped portions of the cables.

2. Insert the wires into the correct holes in the connector, bearing the orientation of the connector in mind.

3. Tighten the set screws of the connector firmly to secure the cables.

The appropriate tightening torque is around 0.5 N·m.



CHECK!

A standard, tapered screwdriver will not enter all the way into the screw holes. Use a small gauge flat-blade screwdriver whose shaft and tip have the same thickness.

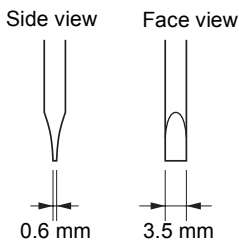

Recommended screwdriver

Manufacturer	Model
OMRON	XW4Z-00C

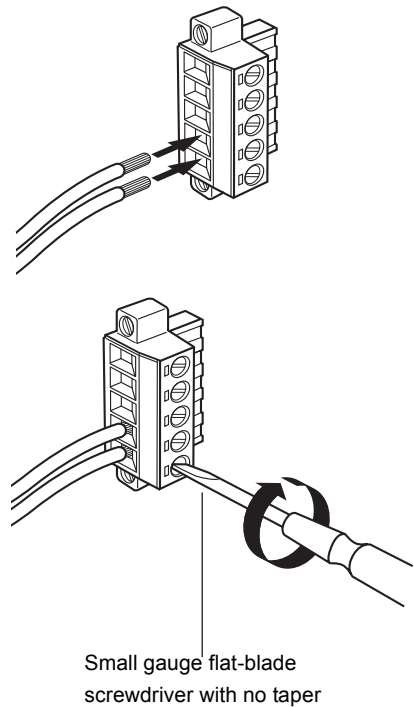

Small gauge flat-blade screwdriver with no taper

4. Having fitted the connector to the cable, connect it to the Link Unit.

Orient the cable connector correctly in relation to the connector on the Link Unit, and fasten the cable connector by fully tightening the retaining screws.

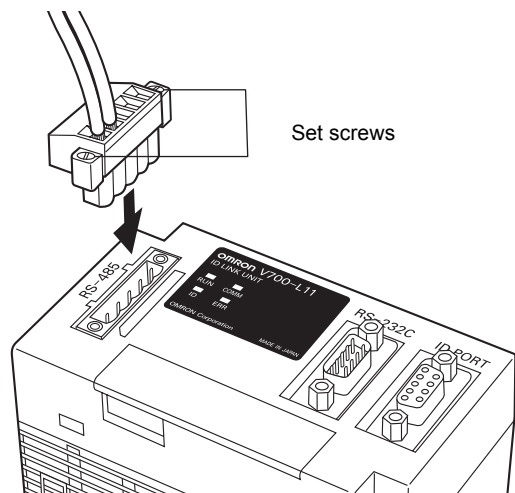

Set screws



CHECK!

Disconnecting the connector

Fully loosen the two screws, then grip the projections on the connector and pull it straight out. If it is difficult to pull the connector out, press down on the Link Unit while pulling on the connector.

SECTION 3

Preparing for Communications

☒ Set the Communications Conditions for the CIDRW Controller	48
☒ Set the Communications Conditions for Amplifier Units	61
☒ Set the Communications Conditions for Link Units	63
☒ Communications Test	65

Set the Communications Conditions for the CIDRW Controller

Set the communications conditions of the CIDRW Controller only when SECS is used.

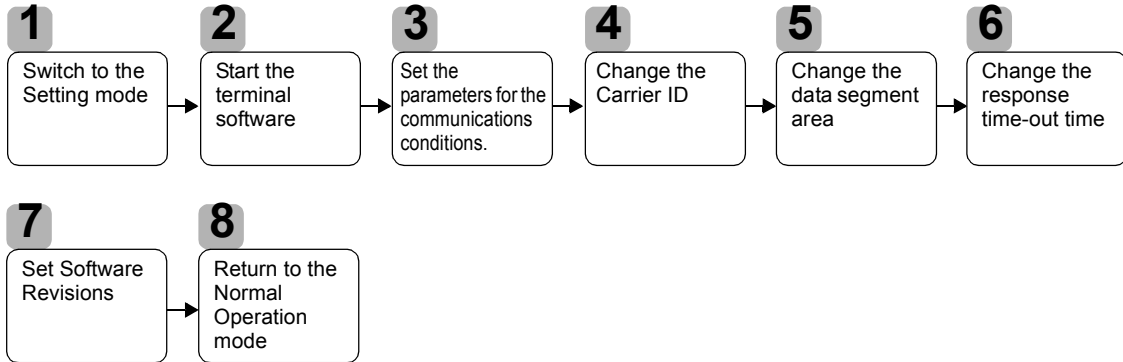

1 Switch to the Setting mode

The CIDRW Controller has two operating modes, the Normal Operation mode and the Setting mode. Switch to the Setting mode to set the communications conditions. There are two methods for switching the mode. Use the one that is appropriate for the circumstances.

■ Changing the Position of the Mode Switch on the Bottom of the Unit

This is the convenient method for setting before mounting the unit.

1. Turn OFF the power to the CIDRW Controller.
2. Set the mode switch on the bottom of the unit to 3.

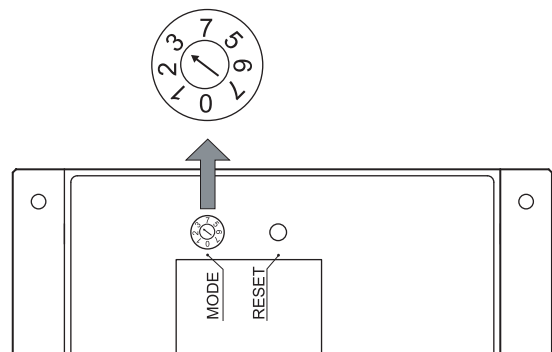

3. When all of the devices to be used are connected, turn the power ON.

The system starts up in the Setting mode, and the indicators react as shown below.

OPERATING	ALARMS	BUSY	ERROR

■ Sending a Switching Command from the Host Device

This method is convenient when the unit has already been mounted and the switch on the bottom cannot be repositioned to 3.

During operation in the Normal Operation mode, a command is sent from the host device to switch to the Setting mode.

1. Send a subsystem command (S18F13 ChangeState CPVAL1 = "PS") from the host device.



Refer to page 77.



CHECK!

CPVAL1="PS" is an expansion designation unique to V700-L22 and does not conform to SEMI standards.

The system is automatically restarted and the mode switches to the Setting mode.
The operation indicators react as shown below.

OPERATING	ALARMS	BUSY	ERROR

2 Start the terminal software

Use the host device's terminal software for the setting.



CHECK!

The commands and communications conditions in the setting mode are unique to OMRON. They do not conform to the SEMI standards. For the terminal software, use Hyper Terminal, which is standard with Windows, or a similar program.

The communications conditions for communication between the host device and CIDRW Controller are fixed. Make the following settings using the terminal software.

Item	Setting
Baud rate	9600 bps
Data length	8 bits
Parity	EVEN
Stop bits	1
Communications control	None
Send code	At the end of a line (when [ENTER] is input), the line feed characters ([LF]) are appended.
Display	Local echo

3 Set the parameters for the communications conditions

Specify the parameters whose settings are to be changed from the terminal software of the host device. The commands, and the parameters that can be set are indicated below.

List of Commands

Designation	Command Input	Explanation
Parameter designation	(Tag name) = (Set value) <CRLF>	Specify the parameter value corresponding to the tag name.
Parameter confirmation	::END	Checks the parameter designations that have been received so far and, if there is no error, confirms the settings.
Comment	# (Comment) <CRLF> or CRLF	This is ignored as the comment line.

Tag Name List

Classification	Parameter	Tag name	Setting range	Default setting
Protocol	Baud Rate	S_BAUD	1200, 2400, 4800, 9600, 19200, 38400, 57600, 115200 bps	9600 bps
	Device ID	S_DEVID	0 to 32767	0
	Time-out between characters	S_T1	0.1 to 10 s	0.5 s
	Protocol time-out	S_T2	0.2 to 25 s	10 s
	Response time-out	S_T3	1 to 120 s	45 s
	Time-out between blocks	S_T4	1 to 120 s	45 s
	Retry limit	S_RTY	0 to 31	3
	Master/slave	S_MS	M: Master S: Slave	M
SECS	Double block detection yes/no	S_DB	1: The header of the block currently being received is compared with the correct block received immediately before, and double blocks are detected. 0: Double block detection is not performed.	0
	Source ID	S_SRC	0 to 32767	0
	Single block No.	S_BNO	0, 1	1
Operation	Baud rate for communications with Amplifier Unit/Link Unit	C_BAUD	9600, 19200, 38400 bps Use a consistent baud rate setting within the same system configuration.	9600 bps
	Number of heads count processing	C_HEAD	0 to 31 0: The number of heads is automatically detected at the start. Any increase or decrease in the number of heads is automatically detected. 1 to 31: The number of heads is specified. The number of heads detected is compared with this specified number of heads. If the number of heads changes, for example because a head fails, an error (with alarm) is detected. If a head is not connected or an error is detected with a connected head, so that the number of heads does not match the specified number, an error (with alarm) is detected.	0



The setting mode commands do not conform to SEMI standards.
For the terminal software, use Hyper Terminal, which is standard with Windows, or a similar program.

1. Specify the parameters to be changed.

When the first parameter is specified, the ALARMS indicator flashes.

```
S_BAUD=19200
S_DEVID=1
S_BNO=0
_
```

2. Confirm the parameter change.

The input parameter is checked and written.

```
::END
_
```

When writing is completed, a message indicating the result is displayed.
The ALARMS indicator lights.

When writing is completed without error

```
SETUP_COMPLETE
_
```

If writing is completed with an error, the parameters are not updated.
The figure in square brackets [] indicates the line number where the error was first detected. If a parity error is detected in the received characters, this figure is [0].
Check the sent data based on this information.

When writing is completed with an error

```
SETUP_FAILED [2]_
_
```



CHECK!

A text file is created based on the data that is keyed in, as shown below, and this data can be conveniently transmitted using the terminal's text file send function.

Example: PRM.TXT

```
#Parameter Setting File for SystemA
#Protocol
S_BAUD=19200
S_DEVID=1
#SECS
S_BNO=0
::END
```

■ Check for Correct Setting

The currently set data can be output so that you can check if it is correct.

1. Send the parameter output command "::GET_PARAM" from the host device.

```
::GET_PARAM
```

The current communication parameter settings are displayed.

```
S_BAUD=19200
S_DEVID=1
S_T1=0.5
S_T2=10.0
S_T3=45
S_T4=3
S_RTY=3
S_MS=M
S_SRC=0
S_BNO=0
C_BAUD=9600
C_HEAD=0
::END
-
```

4 Change the Carrier ID

To read the carrier ID, the CID has to be specified within the area where the carrier ID can be set (CarrierIDField) within the ID tag's memory. This section explains the procedure for setting the carrier ID offset (attribute name: CarrierIDOffset) and the carrier ID size (bytes) (attribute name: CarrierIDLength) in the memory map of the ID tag.

The commands, and the parameters that can be set, are indicated below.

List of Commands

Designation	Command input	Explanation
Parameter designation	(Tag name) = (Set value) <CRLF>	Specify the parameter value corresponding to the tag name.
Parameter confirmation	::END	Checks the parameter designations that have been received so far and, if there is no error, confirms the settings.
Comment	# (Comment) <CRLF> or CRLF	This is ignored as the comment line.

Tag Name List

Parameter	Tag name	Setting range	Default setting
Carrier ID offset	CIDOF	0 - 15	0
Carrier ID size (bytes)	CIDLN	01 - 16	16



- Settings that exceed the carrier ID area (*) cannot be made. If such a setting is made, an error occurs.

*: $(CIDOF + CIDLN) \leq T_CIDLEN$

- The Carrier ID offset and carrier ID size (bytes) can only be changed in the L22 mode. They cannot be changed in the L21 mode. When you change from the L22 mode to the L21 mode, the carrier ID offset and carrier ID size (bytes) are returned to their initial settings.

1. Specify the parameters to be changed.

When the first parameter is specified, the ALARMS indicator flashes.

```
CIDOF=0
CIDLN=16
```

2. Confirm the parameter change.

The input parameter is checked and written.

```
::END
_
```

■ Check for Correct Setting

The currently set data can be output so that you can check if it is correct.

1. Send the parameter output command "::GET_E99SYS" from the host device.

```
::GET_E99SYS
```

The carrier ID settings are displayed.

```
RT=10.0
CT=0.1
RTY=3
DINST=
MENT=
MODEL=L22
HREV=001.04
CIDOF=00
CIDLN=16
::END
_
```



Do not change operation parameters other than RT, CIDOF, and CIDLN. This can cause the system to stop operating correctly.

5 Change the data segment area

The data segment area (memory map) must be changed to communicate with ID Tags (RI-TRP-DR2B, made by Texas Instruments). The procedure for changing the data segment area is explained here.

Data Segment Area Refer to page 129.

The commands, and the parameters that can be set, are indicated below.

List of Commands

Designation	Command input	Explanation
Parameter designation	(Tag name) = (Set value) <CRLF>	Specify the parameter value corresponding to the tag name.
Parameter confirmation	::END	Checks the parameter designations that have been received so far and, if there is no error, confirms the settings.
Comment	# (Comment) <CRLF> or CRLF	This is ignored as the comment line.

Tag Name List

Parameter	Tag name	Setting range	Default setting
Number of bytes in the carrier ID	T_CIDLEN	16 (fixed) The setting must maintain the following relationship (CIDOF + CIDLN) ≤ T_CIDLEN	16
Segment name	T_SEGN	"S01" to "S99"	"S01" to "S28"
Number of bytes in a segment	T_SEGL	8 (fixed)	8

1. The form of the input from the host device is shown in the figure to the right.

When the first parameter is specified, the ALARMS indicator flashes.

```
T_CIDLEN=16
T_SEGN=S01
T_SEGL=8
T_SEGN=S02
T_SEGL=8
T_SEGN=S03
T_SEGL=8
T_SEGN=S04
T_SEGL=8
T_SEGN=S05
T_SEGL=8
T_SEGN=S06
T_SEGL=8
T_SEGN=S07
T_SEGL=8
T_SEGN=S08
T_SEGL=8
T_SEGN=S09
T_SEGL=8
T_SEGN=S10
T_SEGL=8
T_SEGN=S11
T_SEGL=8
T_SEGN=S12
T_SEGL=8
T_SEGN=S13
T_SEGL=8
T_SEGN=S14
T_SEGL=8
T_SEGN=S15
T_SEGL=8
-
```

2. Confirm the parameter change.

The input parameter is checked and written.

```
:::END
-
```

When writing is completed, a message indicating the result is displayed.
 The ALARMS indicator lights.

When writing is completed without error

```
SETUP_COMPLETE
-
```

If writing is completed with an error, the parameters are not updated.
 The figure in square brackets [] indicates the line number where the error was first detected. If a parity error is detected in the received characters, this figure is [0].

When writing is completed with an error

```
SETUP_FAILED [2]_
-
```

Check the sent data based on this information.

■ Check for Correct Setting

The currently set data can be output so that you can check if it is correct.

1. Send the parameter output command "::GET_SEG" from the host device.

```
::GET_SEG
```

The data segment area is displayed.

```
T_CIDLEN=16  
T_SEGN=S01  
T_SEGL=8  
T_SEGN=S02  
T_SEGL=8  
T_SEGN=S03  
T_SEGL=8  
T_SEGN=S04  
T_SEGL=8  
T_SEGN=S05  
T_SEGL=8  
T_SEGN=S06  
T_SEGL=8  
T_SEGN=S07  
T_SEGL=8  
T_SEGN=S08  
T_SEGL=8  
T_SEGN=S09  
T_SEGL=8  
T_SEGN=S10  
T_SEGL=8  
T_SEGN=S11  
T_SEGL=8  
T_SEGN=S12  
T_SEGL=8  
T_SEGN=S13  
T_SEGL=8  
T_SEGN=S14  
T_SEGL=8  
T_SEGN=S15  
T_SEGL=8  
::END  
-
```

6 Change the response time-out time

In the initial settings of the CIDRW Controller, when ID Tag (RI-TRP-DR2B, made by Texas Instruments) data is read or written, a response time-out may occur. Be sure to set the response time-out time to 10 s.

The commands, and the parameters that can be set are indicated below.

List of Commands

Designation	Command input	Explanation
Parameter designation	(Tag name) = (Set value) <CRLF>	Specify the parameter value corresponding to the tag name.
Parameter confirmation	::END	Checks the parameter designations that have been received so far and, if there is no error, confirms the settings.
Comment	# (Comment) <CRLF> or CRLF	This is ignored as the comment line.

Tag Name List

Parameter	Tag name	Setting range	Default setting
Response time-out time	RT	10.0 (fixed)	2.5

1. Set the response time-out time to 10.0.

```
RT=10.0
-
```

2. Confirm the parameter change.

The input parameter is checked and written.

```
::END
-
```

When writing is completed, a message indicating the result is displayed.
The ALARMS indicator lights.

When writing is completed without error

```
SETUP_COMPLETE
-
```

If writing is completed with an error, the parameters are not updated.
The figure in square brackets [] indicates the line number where the error was first detected. If a parity error is detected in the received characters, this figure is [0].

When writing is completed with an error

```
SETUP_FAILED [2]_
```

Check the sent data based on this information.

■ Check for Correct Setting

The currently set data can be output so that you can check if it is correct.

1. Send the parameter output command "::GET_E99SYS" from the host device.

```
::GET_E99SYS
```

The current operation parameter settings are displayed.

```
RT=10.0
CT=0.1
RTY=3
DINST=
MENT=
MODEL=L22
HREV=001.04
CIDOF=00
CIDLN=16
::END
_
```

NOTICE

Do not change operation parameters other than RT, CIDOF, and CIDLN. This can cause the system to stop operating correctly.

7 Set Software Revisions

The operations of the V700-L22 can be changed to match those of the previous model, the V700-L21. The commands, and the parameters that can be set are indicated below.

List of Commands

Designation	Command input	Explanation
Parameter designation	(Tag name) = (Set value) <CRLF>	Specify the parameter value corresponding to the tag name.
Parameter confirmation	::END	Checks the parameter designations that have been received so far and, if there is no error, confirms the settings.
Comment	# (Comment) <CRLF> or CRLF	This is ignored as the comment line.

Tag Name List

Parameter	Tag name	Setting range	Default setting
Software revision	RVER	2.00: in V700-L22 mode 1.10: in V700-L21 mode	2.00

1. Specify the parameters to be changed.
When the first parameter is specified, the ALARMS indicator flashes.

```
RVER=1.10
```

2. Confirm the parameter change.
 The input parameter is checked and written.

```

::END
-
    
```

■ **Check for Correct Setting**

The currently set data can be output so that you can check if it is correct.

1. Send the parameter output command "::GET_VER" from the host device.

```

::GET_VER
    
```

The software revision settings are displayed.

```

RVER=1.10
::END
-
    
```

8 Return to the Normal Operation mode

■ **When the Mode is Selected with the Mode Switch on the Bottom of the Unit**

1. Turn OFF the power to the CIDRW Controller.
2. Set the mode switch on the bottom of the unit to the 0.

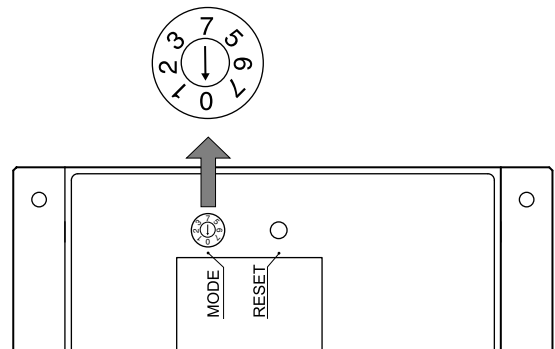

3. When all of the devices to be used are connected, turn the power ON.
 Start up in the Normal Operation mode.



Even if you restart with the mode switch left at the 3 position, or send a reset command "::EXIT," the Controller will start in the Setting mode. To switch to Normal Operation mode, you must set the mode switch to 0.

■ **When the Mode is Selected by a Command Sent from the Host Device**

1. Either send the reset command "::EXIT" from the host device or turn the power to the CIDRW Controller OFF and then back ON.
 Start up in the Normal Operation mode.

```

::EXIT
-
    
```

Reference:

List of Commands

Designation	Command input	Explanation
Parameter designation	(Tag name) = (Set value) <CRLF>	Specify the parameter value corresponding to the tag name.
Parameter confirmation	::END	Checks the parameter designations that have been received so far and, if there is no error, confirms the settings.
Comment	# (Comment) <CRLF> or CRLF	This is ignored as the comment line.
Parameter output	::GET_PARAM	Outputs the set parameters (protocol, SECS, operation).
	::GET_SEG	Outputs the set parameters (ID Tag memory map).
	::GET_E99SYS	Outputs the set parameters (operations).
	::GET_VER	Outputs the set parameters (software revision).
RESET	:EXIT	Restarts the CIDRW Controller.

Tag Name List

Classification	Parameter	Tag name	Setting range	Default setting
Protocol	Baud Rate	S_BAUD	1200, 2400, 4800, 9600, 19200, 38400, 57600, 115200 bps	9600 bps
	Device ID	S_DEVID	0 to 32767	0
	Time-out between characters	S_T1	0.1 to 10 s	0.5 s
	Protocol time-out	S_T2	0.2 to 25 s	10 s
	Response time-out	S_T3	1 to 120 s	45 s
	Time-out between blocks	S_T4	1 to 120 s	45 s
	Retry limit	S_RTY	0 to 31	3
	Master/slave	S_MS	M: Master S: Slave	M
SECS	Double block detection yes/no	S_DB	1: The header of the block currently being received is compared with the correct block received immediately before, and double blocks are detected. 0: Double block detection is not performed.	0
	Source ID	S_SRC	0 to 32767	0
	Single block No.	S_BNO	0, 1	1
Operation	Baud rate for communications with Amplifier Unit/Link Unit	C_BAUD	9600, 19200, 38400 bps Use a consistent baud rate setting within the same system configuration.	9600 bps
	Number of heads count processing	C_HEAD	0 to 31 0: The number of heads is automatically detected at the start. Any increase or decrease in the number of heads is automatically detected. 1 to 31: The number of heads is specified. The number of heads detected is compared with this specified number of heads. If the number of heads changes, for example because a head fails, an error (with alarm) is detected. If a head is not connected or an error is detected with a connected head, so that the number of heads does not match the specified number, an error (with alarm) is detected.	0
ID Tag	Number of bytes in the carrier ID	T_CIDLEN	16 (fixed)	16
	Segment name	T_SEGN	"S01" - "S99"	"S01" - "S28"
	Number of bytes in a segment	T_SEGL	8 (fixed)	8

Tag Name List

Classification	Parameter	Tag name	Setting range	Default setting
E99	Response timeout time	RT	10.0 s (fixed)	2.5 s
	Carrier ID offset	CIDOF	00 - 15	00
	Carrier ID length	CIDLEN	01 - 16	16

Set the Communications Conditions for Amplifier Units

Set the communications conditions using the DIP switches on the side face of the Amplifier Unit. After changing the DIP switch settings, restart the system. The new settings will not become effective until the system is restarted.

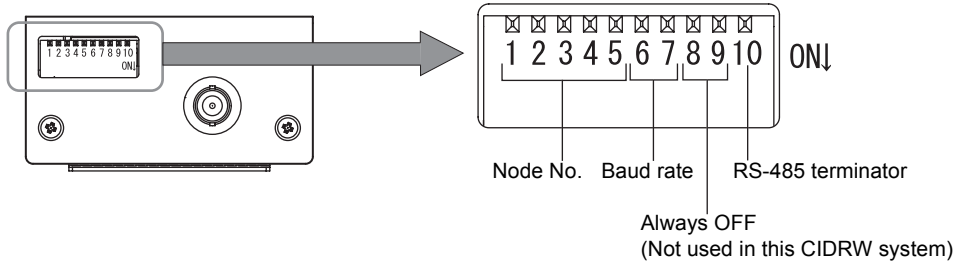

Node No.

Node No.	DIP-SW				
	1	2	3	4	5
01	OFF	OFF	OFF	OFF	OFF
02	ON	OFF	OFF	OFF	OFF
03	OFF	ON	OFF	OFF	OFF
04	ON	ON	OFF	OFF	OFF
05	OFF	OFF	ON	OFF	OFF
06	ON	OFF	ON	OFF	OFF
07	OFF	ON	ON	OFF	OFF
08	ON	ON	ON	OFF	OFF
09	OFF	OFF	OFF	ON	OFF
10	ON	OFF	OFF	ON	OFF
11	OFF	ON	OFF	ON	OFF
12	ON	ON	OFF	ON	OFF
13	OFF	OFF	ON	ON	OFF
14	ON	OFF	ON	ON	OFF
15	OFF	ON	ON	ON	OFF
16	ON	ON	ON	ON	OFF

Node No.	DIP-SW				
	1	2	3	4	5
17	OFF	OFF	OFF	OFF	ON
18	ON	OFF	OFF	OFF	ON
19	OFF	ON	OFF	OFF	ON
20	ON	ON	OFF	OFF	ON
21	OFF	OFF	ON	OFF	ON
22	ON	OFF	ON	OFF	ON
23	OFF	ON	ON	OFF	ON
24	ON	ON	ON	OFF	ON
25	OFF	OFF	OFF	ON	ON
26	ON	OFF	OFF	ON	ON
27	OFF	ON	OFF	ON	ON
28	ON	ON	OFF	ON	ON
29	OFF	OFF	ON	ON	ON
30	ON	OFF	ON	ON	ON
31	OFF	ON	ON	ON	ON
Setting not possible	ON	ON	ON	ON	ON

Always set node numbers that are unique within the system configuration. When SECS is used, the node number set here is "HeadID(E99)."

Baud rate

Option	DIP-SW		Description
	6	7	
38400 bps	ON	ON	Use a consistent baud rate setting within the same system configuration.
19200 bps	OFF	ON	
9600 bps (default setting)	OFF	OFF	
4800 bps	ON	OFF	

RS-485 terminator

Option	DIP-SW	Description
	10	
Invalid	OFF	Set ON at both of the end units in a multidrop system, and OFF at all the other units. If there is only one unit, set ON. If there is a possibility that one of multiple Amplifier Units in use may be used independently, turn the terminators of all the Amplifier Units OFF and fit external terminators close to the units at both ends.
Valid	ON	

Communications conditions

Item	Specifications				
Standard conformed to	RS-232C				
Communications control protocol	1:N protocol exclusive to OMRON				
Synchronization method	Start-stop synchronization				
Baud rate	Set using a DIP switch				
Frame composition	Start bit	Data bits	Parity bit	Stop bit	Total
	1	8	None	1	10
Error detection	FCS (frame check sequence)				

Set the Communications Conditions for Link Units

Set the communications conditions by setting the DIP switches.

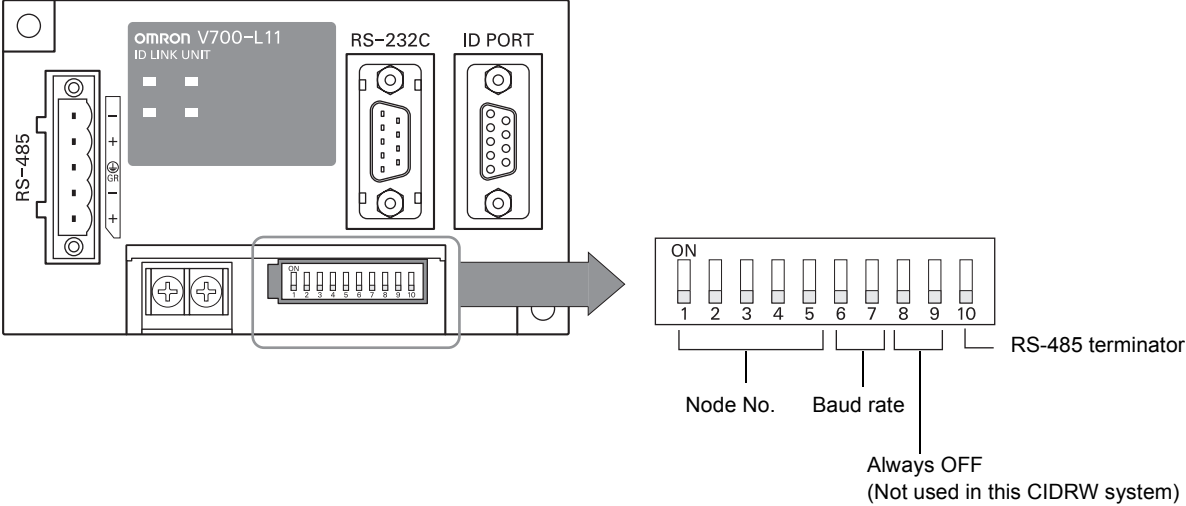

Node No. (fixed)

DIP-SW				
1	2	3	4	5
ON	ON	ON	ON	ON



The node numbers for Link Units are fixed. Check that DIP switches 1 to 5 are all ON.

Baud rate

Option	DIP-SW		Description
	6	7	
38400 bps	ON	ON	Use a consistent baud rate setting within the same system configuration.
19200 bps	OFF	ON	
9600 bps (default setting)	OFF	OFF	
4800 bps	ON	OFF	

RS-485 terminator

Option	DIP-SW	Description
	10	
Invalid	OFF	Set ON.
Valid	ON	

Communications conditions

Item	Specifications				
Standard conformed to	RS-232C				
Communications control protocol	1:N protocol exclusive to OMRON				
Synchronization method	Start-stop synchronization				
Baud rate	Set using a DIP switch				
Frame composition	Start bit	Data bits	Parity bit	Stop bit	Total
	1	8	None	1	10
Error detection	FCS (frame check sequence)				

Communications Test

Test for Communications with the Host Device

Check if the host device, CIDRW Controller, and Amplifier Units are correctly connected.

When SECS is Used

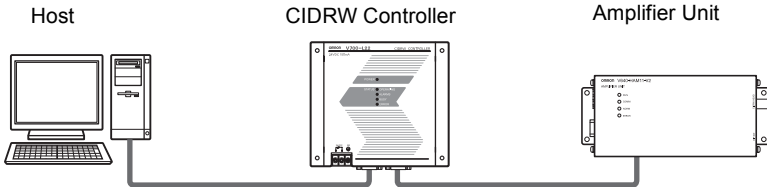

- Connection between host device and CIDRW Controller
Send **Are You There Request** message "S1, F1" from the host device.
If it is correctly connected, **On Line Data** "S1, F2" will be sent from the CIDRW Controller.
- Connection between the CIDRW Controller and Amplifier Unit
The connection between the CIDRW Controller and Amplifier Unit is checked automatically. If they are connected correctly, the operation indicators on the CIDRW Controller light in the manner shown below.

POWER	OPERATING	ALARMS	BUSY	ERROR
☉	☉	●	●	●

When SECS is Not Used

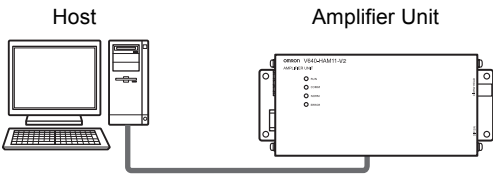

Node No.1 is tested with the data 12345678.

Command

SOH	Node No.		Command code		Test data								FCS		CR
					Data 1		Data 2		Data 3		Data 4				
01h	0	1	1	0	1	2	3	4	5	6	7	8	0	8	0Dh

Response

SOH	Node No.		Response code		Test data								FCS		CR
					Data 1		Data 2		Data 3		Data 4				
01h	0	1	0	0	1	2	3	4	5	6	7	8	0	9	0Dh

ID Tag ↔ CIDRW System Communications Test

Send a command from the host device and check that normal communication with the ID Tag is possible.

■ When SECS is Used

• Read ID

The host device sends a **Read ID Request** message to the CIDRW Controller for Head 1. The CIDRW Head 1 reads the ID, and the CIDRW Controller returns the ID to the host device.

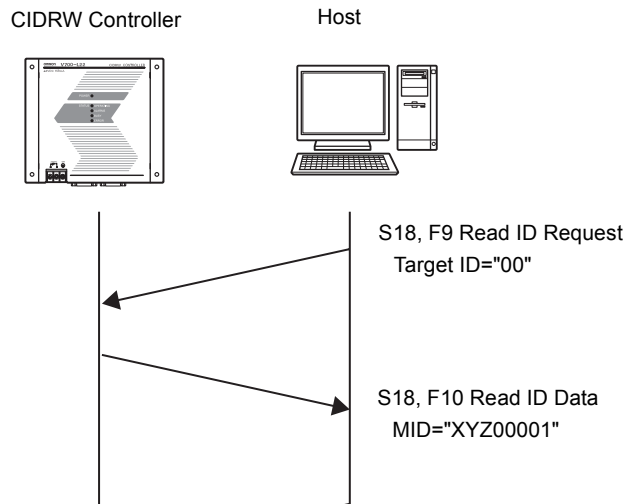

• Read Data

The host device sends a **Read Data Request** message to the CIDRW Controller for Head 1, DataSeg S01 and Datalength 8. The CIDRW Head 1 reads the data, and the CIDRW Controller returns the data to the host device.

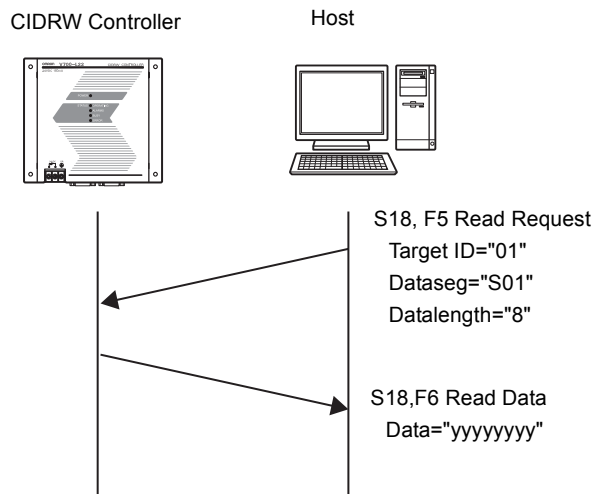

• Write ID

- (1) The CIDRW Controller is in IDLE. The host device requests the CIDRW Controller change its operational status to MAINTENANCE.
- (2) The CIDRW Controller changes to MAINTENANCE and replies that it has changed state.
- (3) The host device sends a **Write ID Request** message to the CIDRW Controller for Head 1. The CIDRW Head 1 writes ID, and the CIDRW Controller returns the ID to the host devices.

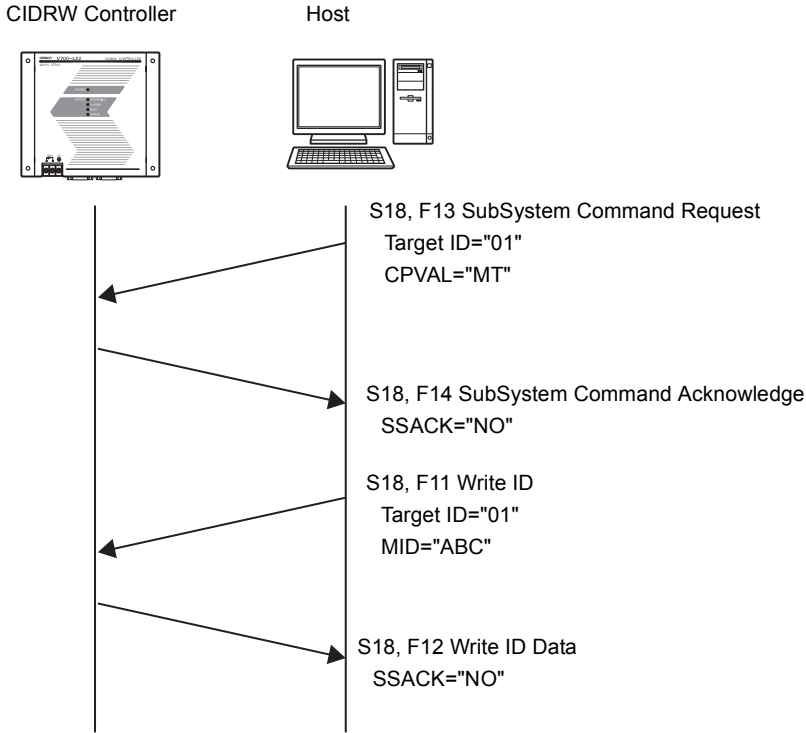

• Write Data

The host device sends a **Write Data Request** message to the CIDRW Controller for Head 1 and Data-Seg S02. The CIDRW Head 1 writes the data, and the CIDRW Controller returns the results to the host device.

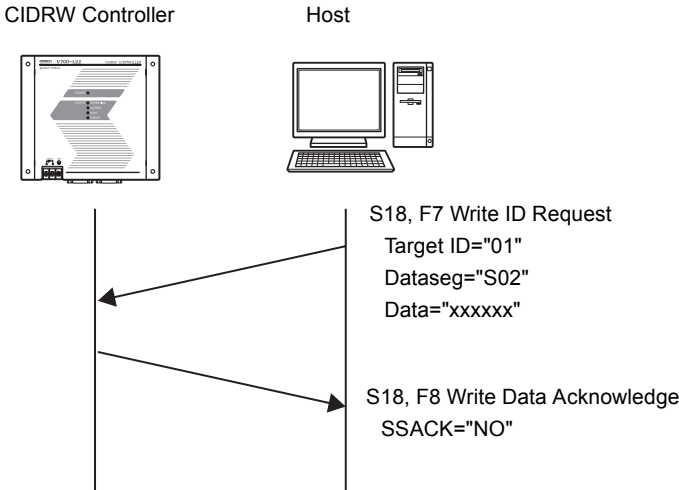

SECTION 4

Reading from/Writing to ID Tags

☒ When SECS is Used	70
☒ When SECS is Not Used	81

When SECS is Used



The SEMI standards are subject to revision. You must refer to the actual standards.

- SEMI E99 THE CARRIER ID READER/WRITER FUNCTIONAL STANDARD
- SEMI E5 EQUIPMENT COMMUNICATION STANDARD 2 MESSAGE CONTENT (SECS II)
- SEMI E4 EQUIPMENT COMMUNICATION STANDARD 1 MESSAGE TRANSFER (SECS I)

SECS Protocol Specifications  Refer to page 131.



Message Specifications

List of Messages Used

Classification	S	F	Direction	SECS II names	See
General purpose messages	1	1	S,H→E,reply	Are You There Request	p.72
	1	2	S,H←E	On Line Data	p.72
CIDRW system messages	18	1	S,H→E,reply	Read Attribute Request	p.72
	18	2	S,H←E	Read Attribute Data	p.72
	18	3	S,H→E,reply	Write Attribute Request	p.73
	18	4	S,H←E	Write Attribute Acknowledge	p.73
	18	5	S,H→E,reply	Read Request	p.74
	18	6	S,H←E	Read Data	p.74
	18	7	S,H→E,reply	Write Request	p.75
	18	8	S,H←E	Write Acknowledge	p.75
	18	9	S,H→E,reply	Read ID Request	p.76
	18	10	S,H←E	Read ID Data	p.76
	18	11	S,H→E,reply	Write ID Request	p.76
	18	12	S,H←E	Write ID Acknowledge	p.76
	18	13	S,H→E,reply	Subsystem Command Request	p.77
	18	14	S,H←E	Subsystem Command Acknowledge	p.77

List of Error Messages  Refer to page 92.

Data Item Dictionary

SECS II data items	Name	Format	Value
ATTRID	Attribute ID	20	Attribute name
ATTRVAL	Attribute value	20	Attribute value
MID	Carrier ID	MID	20 ₁₆ - 7E ₁₆ (Visible ASCII)
DATA	Data	20	All characters 00H-0FFH
DATALENGTH	DataSize	52	Offset designation: 1 - 224 Segment designation:  Refer to Data Segment Area page 129.
DATASEG	DataSeg	20	Offset designation: "00", "01"... "0222", "0223" Segment designation:  Refer to Data Segment Area page 129.
STATUS	PM information	20	"NE": Normally executed

Data Item Dictionary

SECS II data items	Name	Format	Value
SSACK	Result status	20	"NO": Normal "EE": Execution error *3 "CE": Communications error "HE": Hardware error *3 "TE": Tag error *3
List of STATUS	Status	L,4 1.<PMInformation> 2.<AlarmStatus> 3.<OperationalStatus> 4.<HeadStatus> *2	The STATUS values are included in the PM information.
CPVAL	State request	20	"OP", "MT", "PS" *1
TARGETID	Target ID	20	"00"- "31" "00" indicates the CIDRW Controller itself.
SSCMD	Subsystem commands	20	"ChangeState" "GetStatus" "PerformDiagnostics" "Reset"

*1: "PS" is an expansion command for this unit.

*2: When the TARGET ID is "00" (CIDRW), this is a zero length item.

*3: "EE," "HE," and "TE" are used only with S18F6, S18F8, S18F10, and S18F12.



S9F7 responses

An S9F7 response is given when a message in an illegal format is received from the host device.

"Illegal format" here means that there is a problem with the message composition, such as illegal attributes, or insufficient or too many items. If other problems relating to the item contents arise, the response is SSACK = "CE" (communications error).



Communications with the Host Device

Communicate with the host device only after confirming that the CIDRW Controller has started. Also, unstable signals may occur at the host interface when the CIDRW Controller is started. When initializing operation, clear the reception buffer at the host device or take other suitable methods to clear unwanted signals.

■ Specifications for Each Stream/Function

• Online check

S1,F1	Are You There Request	S,H→E,reply
		Header only

S1,F2	On Line Data	S,H←E
L,2		
	1.<MDLN>	
	2.<SOFTREV>	
	<ul style="list-style-type: none"> • Set MDLN (model number). • Set SOFTREV (software revision level). 	

• Get attributes

S18,F1	Read Attribute Request	S,H→E,reply
L,2		
	1.<TARGETID>	"00"->"31"
	2.L,n	
	1.<ATTRID1>	
	.	
	n.<ATTRIDn>	
	<ul style="list-style-type: none"> • The setting for reading all attributes (CIDRW Controller or heads) is n = 0. 	

S18,F2	Read Attribute Data	S,H←E
L,4		
	1.<TARGETID>	"00"->"31"
	2.<SSACK>	
	3.L,n	
	1.<ATTRVAL1>	
	.	
	n.<ATTRVALn>	
	4.L,s	
	1.<STATUS1>	
	.	
	s.<STATUSs>	
	<ul style="list-style-type: none"> • The order of the attribute data corresponds to the attribute ID specified by S18, F1. When reading of all attributes is specified, unsupported attribute items (ATTRVAL) are omitted. • When the specified target is invalid: n = 0, s = 0, SSACK = "CE" communications error • When one or more undefined attributes are included: n = 0, s = 0, SSACK = "CE" communications error • When head attributes are specified with TARGET = "00" or CIDRW Controller attributes are specified with TARGET <> "00": n = 0, s = 0, SSACK = "CE" communications error • If the status of SSACK is other than "NO" (normal), the List of Status will comprise zero items. 	

• Set attributes

F18,F3	Write Attribute Request	S,H→E,reply
L,2		
	1.<TARGETID>	"00" (fixed)
	2.L,n	
	1.L,2	
	1.<ATTRID1>	
	2.<ATTRVAL1>	
	n.L,2	
	1.<ATTRIDn>	
	2,<ATTRVALn>	
<p>Since the attributes for heads are all RO in this system, the target ID is fixed as "00".</p>		

S18,F4	Write Attribute Acknowledge	S,H←E
L,3		
	1.<TARGETID>	"00" (fixed)
	2.<SSACK>	
	3.L,s	
	1.<STATUS1>	
	.	
	s.<STATUSs>	
<ul style="list-style-type: none"> • When the specified target is invalid: s = 0, SSACK = "CE" communications error • When one or more undefined attributes or RO attributes are included: s = 0, SSACK = "CE" communications error • When illegal attribute data is specified: s = 0, SSACK = "CE" communications error • If the status of SSACK is other than "NO" (normal), the List of Status will comprise zero items. 		

• Read data

S18,F5	Read Request	S,H→E,reply
L,3		
	1.<TARGETID>	"01"->"31"
	2.<DATASEG>	
	3.<DATALENGTH>	
<ul style="list-style-type: none"> • When DATASEG is specified as "0" and a character string, the size of data determined by the DATALENGTH setting is read, starting from the address indicated by the DATASEG setting. If DATALENGTH = 0, data is read up to the end of the data area. • If DATASEG is specified as a character string, a size of data determined by DATALENGTH, starting from the address specified by DATASEG, is read (segment specification). • When the data of all segments is batch read, both DATASEG and DATALENGTH are omitted (they are zero length items). • When all the data for a particular segment is read, DATALENGTH is omitted (it is a zero length item). • In a segment specification, it is not possible to specify a DATALENGTH that exceeds the maximum length of the relevant DATASEG. • In a segment specification, if a DATALENGTH that is under the set length for DATASEG is specified, only the data corresponding to specified DATALENGTH is read. 		

Data Segment Area



Refer to page 129.

S18,F6	Read Data	S,H→E,reply
L,4		
	1.<TARGETID>	"01"->"31"
	2.<SSACK>	
	3.<DATA>	
	4.L,s	
	1.<STATUS1>	
	.	
	s.<STATUSs>	
<ul style="list-style-type: none"> • When the specified target is invalid: DATA item length = 0, s = 0, SSACK = "CE" communications error • In an address specification, if: $(\text{SEGMENT} + \text{DATALENGTH}) \leq \text{total value for all segments}$ then SSACK = "NO" • In an address specification, if: $(\text{SEGMENT} + \text{DATALENGTH}) > \text{total value for all segments}$ then DATA item length = 0, s = 0, SSACK = "CE" communications error • In a segment specification, if an undefined DATASEG is specified, or if the DATALENGTH is illegal: DATA item length = 0, s = 0, SSACK = "CE" communications error • When reading of all segment data is specified in a system where the data segment is not defined: DATA length = 0, SSACK = "NO" • If the status of SSACK is other than "NO" (normal), the List of Status will comprise zero items. 		

• Write data

S18,F7	Write Request	S,H→E,reply
L,4		
	1.<TARGETID>	"01"->"31"
	2.<DATASEG>	
	3.<DATALENGTH>	
	4.<DATA>	
<ul style="list-style-type: none"> • If DATASEG is specified as "0" and a character string, a size of data corresponding to the DATALENGTH setting and starting from the address within the data area indicated by the DATASEG setting is written (address specification). If DATALENGTH = 0, data is written up to the end of the data area. • If DATASEG is specified as a character string, a size of data determined by DATALENGTH, starting from the address specified by DATASEG, is written (segment specification). • When the data for all segments is batch written, both DATASEG and DATALENGTH are omitted (they are zero length items). • When all the data for a particular segment is written, DATALENGTH is omitted (it is a zero length item). • In a segment specification, it is not possible to specify a DATALENGTH that exceeds the maximum length of the relevant DATASEG. • In a segment specification, if a DATALENGTH that is under the set length for DATASEG is specified, only the data corresponding to the specified DATALENGTH is written, compressed into the smaller addresses. • The item lengths of DATASEG and DATA must be matched. • If DATASEG and DATALENGTH are both omitted (made zero length items), the length of DATA must match the total of the set lengths of all segments. 		

Data Segment Area  Refer to page 129.

S18,F8	Write Acknowledge	S,H←E
L,3		
	1.<TARGETID>	"01"->"31"
	2.<SSACK>	
	3.L,s	
	1.<STATUS1>	
	.	
	s.<STATUSs>	
<ul style="list-style-type: none"> • When the specified target is invalid: s = 0, SSACK = "CE" communications error • In an address specification, if: (SEGMENT + DATALENGTH) ≤ total value for all segments then SSACK = "NO" • In an address specification, if: (SEGMENT + DATALENGTH) > total value for all segments then DATA item length = 0, s = 0, SSACK = "CE" (communications error) • In a segment specification, if DATASEG and DATALENGTH are illegal: s = 0, SSACK = "CE" communications error • If the status of SSACK is other than "NO" (normal), the List of Status will comprise zero items. 		

• **Read ID**

S18,F9	Read ID Request	S,H→E,reply
1.<TARGETID>		"01"->"31"

Data Segment Area  Refer to page 129.

S18,F10	Read ID Data	S,H←E
L,4		
1.<TARGETID>		"01"->"31"
2.<SSACK>		
3.<MID>		
4.L,s		
1.<STATUS1>		
.		
s.<STATUSs>		
<ul style="list-style-type: none"> • If the MID data contains Non-Visible ASCII code: s = 0, MID item length = 0, SSACK = "EE" execution error • When the specified target is invalid: s = 0, MID item length = 0, SSACK = "CE" communications error • If the status of SSACK is other than "NO" (normal), the List of Status will comprise zero items. 		

• **Write ID**

S18,F11	Write ID Request	S,H→E,reply
L,2		
1.<TARGETID>		"01"->"31"
2.<MID>		
<ul style="list-style-type: none"> • If an MID that is under the length set for the CarrierIDlength attribute is specified, an error occurs and the MID data is not written. 		

Data Segment Area  Refer to page 129.

S18,F12	Write ID Acknowledge	S,H←E
L,3		
1.<TARGETID>		"01"->"31"
2.<SSACK>		
3.L,s		
1.<STATUS1>		
.		
s.<STATUSs>		
<ul style="list-style-type: none"> • When the specified target is invalid: s = 0, SSACK = "CE" communications error • When there is an MID length error: s = 0, SSACK = "CE" communications error • If the MID data contains Non-Visible ASCII code: s = 0, SSACK = "EE" execution error • If the status of SSACK is other than "NO" (normal), the List of Status will comprise zero items. 		

• Subsystem command (ChangeState)

S18,F13	Subsystem Command Request (ChangeState)	S,H→E,reply
L,3		
	1.<TARGETID>	"00" (fixed)
	2.<SSCMD>	"ChangeState"
	3.L,1	
	1.<CPVAL1>	"OP", "MT" or "PS"
CPVAL = "PS" is a parameter setting unique to this CIDRW Controller for switching to the Setting mode.		

S18,F14	Subsystem Command Acknowledge (ChangeState)	S,H←E
L,3		
	1.<TARGETID>	"00"
	2.<SSACK>	
	3.L,s	
	1.<STATUS1>	
	.	
	s.<STATUSs>	
<ul style="list-style-type: none"> • When the specified target is invalid: s = 0, SSACK = "CE" communications error • When SSCMD is invalid: s = 0, SSACK = "CE" communications error • When OperationalStatus is BUSY: s = 0, SSACK = "EE" execution error • If the status of SSACK is other than "NO" (normal), the List of Status will comprise zero items. 		

• Subsystem command (GetStatus)

S18,F13	Subsystem Command Request (GetStatus)	S,H→E,reply
L,3		
	1.<TARGETID>	"00"->"31"
	2.<SSCMD>	"GetStatus"
	3.L,0	

S18,F14	Subsystem Command Acknowledge (GetStatus)	S,H←E
L,3		
	1.<TARGETID>	"00"->"31"
	2.<SSACK>	"GetStatus"
	3.L,s	
	1.<STATUS1>	
	.	
	s.<STATUSs>	
<ul style="list-style-type: none"> • When the specified target is invalid: s = 0, SSACK = "CE" communications error • When SSCMD is invalid: s = 0, SSACK = "CE" communications error • If the status of SSACK is other than "NO" (normal), the List of Status will comprise zero items. 		

• Subsystem command (PerformDiagnostics)

S18,F13	Subsystem Command Request (PerformDiagnostics)	S,H→E,reply
L,3		
	1.<TARGETID>	"00"->"31"
	2.<SSCMD>	"PerformDiagnostics"
	3.L,0	

S18,F14	Subsystem command Acknowledge (PerformDiagnostics)	S,H←E
L,3		
	1.<TARGETID>	"00"->"31"
	2.<SSACK>	
	3.L,s	
	1.<STATUS1>	
	.	
	s.<STATUSs>	
<ul style="list-style-type: none"> • When the specified target is invalid: s = 0, SSACK = "CE" communications error • When SSCMD is invalid: s = 0, SSACK = "CE" communications error • If the status of SSACK is other than "NO" (normal), the List of Status will comprise zero items. 		

• Subsystem command (Reset)

S18,F13	Subsystem Command Request (Reset)	S,H→E,reply
L,3		
	1.<TARGETID>	"00" (fixed)
	2.<SSCMD>	"Reset"
	3.L,0	

S18,F14	Subsystem Command Acknowledge (Reset)	S,H←E
L,3		
	1.<TARGETID>	"00"
	2.<SSACK>	
	3.L,0	
<ul style="list-style-type: none"> • When the specified target is invalid: SSACK = "CE" communications error • When SSCMD is invalid: SSACK = "CE" communications error 		

■ Operation Conditions

The response messages and response codes (SSACK) in each state are shown below.

State		Initializing	Operating		Maintenance
Message	Function		IDLE	BUSY	
S1,F1	OnlineRequest	S1,F0	S1,F2	S1,F2	S1,F2
S18,F11	WriteID	S18,F0	S18,F0	S18,F0	NO
S18,F7	WriteData	S18,F0	NO	NO	S18,F0
S18,F3	SetAttribute	S18,F0	NO	NO	NO
S18,F13(Reset)	Reset	S18,F0	NO	NO	NO
S18,F9	ReadID	S18,F0	NO	NO	NO
S18,F5	ReadData	S18,F0	NO	NO	S18,F0
S18,F13(PerformDiagnostics)	Diagnostics	S18,F0	NO	NO	NO
S18,F13(GetStatus)	GetStatus	S18,F0	NO	NO	NO
S18,F1	GetAttribute	S18,F0	NO	NO	NO
S18,F13(ChangeState)	ChangeState(to MT)	S18,F0	NO	S18,F0	S18,F0
S18,F13(ChangeState)	ChangeState(to OP)	S18,F0	S18,F0	S18,F0	NO
S18,F13(ChangeState)	ChangeState(to PS)	S18,F0	NO	S18,F0	NO

When SECS is Not Used

Command/Response Format

Command

SOH	Node No.		Command code				Parameter				FCS		CR
							1	...	n				
01h													0Dh

Response

SOH	Node No.		Response code		Parameter				FCS		CR
					1	...	n				
01h											0Dh



Meaning of FCS (frame check sequence)

This is two ASCII code characters obtained by conversion from the 8-bit exclusive logical sum (EOR) of the characters from the character immediately after SOH to the character immediately before FCS.

Example: Reading the data of page 1 and page 2 of node No.1

Command [SOH]010100000000C[FCS][CR]
└──────────┘
Calculation range

```
' 0' (30h) = 0011 0000
' 1' (31h) = 0011 0001
' 0' (30h) = 0011 0000
' 1' (31h) = 0011 0001
' 0' (30h) = 0011 0000
' 0' (30h) = 0011 0000
' 0' (30h) = 0011 0000
' 0' (30h) = 0011 0000
' 0' (30h) = 0011 0000
' 0' (30h) = 0011 0000
' 0' (30h) = 0011 0000
' 0' (30h) = 0011 0000
' 0' (30h) = 0011 0000
' 0' (30h) = 0011 0000
' 0' (30h) = 0011 0000
' 0' (30h) = 0011 0000
' 0' (30h) = 0011 0000
' C' (43h) = 0100 0011
              0111 0011
              ↓  ↓
              7  3
(ASCII conversion)↓
              ' 7' (37h) ' 3' (33h)
```

Command

Command code list

Name	Value	Function	See
READ	0100	When this command is received, the system communicates with the ID Tag, and reads the specified page(s) of data. Any pages up to a maximum of 16 can be selected.	p.83
WRITE	0200	When this command is received, the system communicates with the ID Tag, and writes the specified page(s) of data. Any pages up to a maximum of 16 can be selected.	p.84
Same Write	0300	When this command is received, the system communicates with the ID Tag, and writes the same data in page units to the specified pages. Up to 17 pages, which is the maximum number of pages for an ID Tag, can be specified.	p.86
Byte Write	0400	When this command is received the system communicates with the ID Tag, and writes data to the area specified by a first address and number of bytes. A maximum of 128 bytes can be specified.	p.87
TEST	10	Sends received data to the host device.	p.88
NAK	12	Sends the response made immediately before again.	p.89
Noise measurement	40	Measures the noise in the vicinity of the CIDRW Head.	p.89
RESET	7F	Resets the Amplifier Unit.	p.89

Response code list

Type	Response code	Name	Description
Normal end	00	Normal end	Command execution is completed normally.
Host communications error	14	Format error	There is a mistake in the command format. (E.g. the command code is undefined, or the page or address specification is inappropriate.)
Communications error	70	Communications error	Noise or another hindrance occurs during communication with an ID Tag, and communications cannot be completed normally.
	71	Verification error	Correct data cannot be written to an ID Tag.
	72	No Tag error	Either there is no ID Tag in front of the CIDRW Head, or the CIDRW Head is unable to detect the ID Tag due to environmental factors (e.g. noise).
	7B	Outside write area error	Writing is not completed normally.
	7E	ID system error (1)	The ID Tag is in a status where it cannot execute command processing.
	7F	ID system error (2)	An inapplicable ID Tag has been used.



Communications with the Host Device

Communicate with the host device only after confirming that the CIDRW Controller has started. Also, unstable signals may occur at the host interface when the CIDRW Controller is started. When initializing operation, clear the reception buffer at the host device or take other suitable methods to clear unwanted signals.

■ READ

Reads any pages of data from the ID Tag. The maximum number of pages that can be read at one time is 16.

Command

SOH	Node No.		Command code				Page designation (8 characters)								FCS		CR			
01h			0	1	0	0														0Dh

Bit	7	-	0	7	-	3	2	1	0	7	6	-	1	0	7	6	-	2	1	0
Page	Sys	-	Sys	Sys	-	Sys	17	16	15	14	13	-	8	7	6	5	-	1	Sys	Sys
Designation	0*	0*		0*	0*	0*	0/1	0/1	0/1	0/1	0/1	...	0/1	0/1	0/1	0/1	...	0/1	0*	0*
Value	00		00 - 07				00 - FF				00 - FC									

* Always specify 0. If you specify 1 an error (Response code: 14) will occur.

Parameter description

Parameter	Description
Page designation	Pages are specified by setting the bits corresponding to pages that are to be read to 1 and setting the other bits to 0, then converting the result to a hexadecimal character string.

Data Segment Area



Refer to page 129.

The response code (when normal: 00) and the data in the specified pages are returned in ascending order of page numbers.

Response

SOH	Node No.	Response code	Read data												FCS	CR
			Page n				...	Page m (n<m)								
			Data 1	...	Data 8	Data 1		...	Data 8							
01h			0	0												0Dh

Example: Reading the data of pages 1 and 3 of node No.1

Data content of the ID Tag

Page 1	12h	34h	56h	78h	90h	12h	34h	56h
Page 2								
Page 3	11h	22h	33h	44h	55h	66h	77h	88h
Page 4								

Command

SOH	Node No.		Command code				Page designation								FCS		CR
01h	0	1	0	1	0	0	0	0	0	0	0	0	1	4	0	5	0Dh

Binary notation

0	0	0	0	0	0	0	0	0	0	0	0	0	0	0	0	0	0	0	0	0	0	0	0	0	0	0	0	0	0	0	0	0	0	0	1	0	1	1	0	0
---	---	---	---	---	---	---	---	---	---	---	---	---	---	---	---	---	---	---	---	---	---	---	---	---	---	---	---	---	---	---	---	---	---	---	---	---	---	---	---	---

Response

SOH	Node No.		Response code		Page 1																Page 3																FCS	CR	
01h	0	1	0	0	1	2	3	4	5	6	7	8	9	0	1	2	3	4	5	6	1	1	2	2	3	3	4	4	5	5	6	6	7	7	8	8	0	7	0Dh

WRITE

Data is written in page units to the ID Tag. Any page(s) can be specified. It is possible to write to a maximum of 16 pages at one time.

Command

SOH	Node No.	Command code	Page designation (8 characters)	Write data																FCS	CR																
				Page n								...	Page m (n<m)																								
				Data 1	...	Data 8	Data 1	...	Data 8																												
01h		0 2 0 0																																			0DH

Bit	7	-	0	7	-	3	2	1	0	7	6	-	1	0	7	6	-	2	1	0
Page	Sys	-	Sys	Sys	-	Sys	17	16	15	14	13	-	8	7	6	5	-	1	Sys	Sys
Designation	0*	0*		0*	0*	0*	0/1	0/1	0/1	0/1	0/1	...	0/1	0/1	0/1	0/1	...	0/1	0*	0*
Value	00			00 - 07						00 - FF						00 - FC				

* Always specify 0. If you specify 1 an error (Response code: 14) will occur.

Parameter description

Parameter	Description
Page designation	Pages are specified by setting the bits corresponding to pages that are to be read to 1 and setting the other bits to 0, then converting the result to a hexadecimal character string.
Write data	The data to be written to the specified pages is specified in ascending order of page numbers.

Data Segment Area



Refer to page 129.

Response

The response code (when normal: 00) is returned.

SOH	Node No.	Response code		FCS	CR
01h		0	0		0Dh

Example: Writing data to pages 8 and 10 of node No.1

Command

SOH	Node No.		Command code			Page designation				Data of page 8								Data of page 10								FCS		CR																			
01h	0	1	0	2	0	0	0	0	0	A	0	0	1	1	2	2	3	3	4	4	5	5	6	6	7	7	8	8	0	1	2	3	4	5	6	7	8	9	A	B	C	D	E	F	7	4	0Dh

Binary notation

0	0	0	0	0	0	0	0	0	0	0	0	0	0	0	0	0	0	0	0	0	0	0	0	1	0	1	0	0	0	0	0	0	0	0	0	0	0	0	0	0	0	0	0	0
---	---	---	---	---	---	---	---	---	---	---	---	---	---	---	---	---	---	---	---	---	---	---	---	---	---	---	---	---	---	---	---	---	---	---	---	---	---	---	---	---	---	---	---	---

Response

SOH	Node No.		Response code		FCS		CR
01h	0	1	0	0	0	1	0Dh

The ID Tag status on normal completion is as shown below.

Page 8	11h	22h	33h	44h	55h	66h	77h	88h
Page 9								
Page 10	01h	23h	45h	67h	89h	ABh	CDh	EFh

Same Write

Writes the same data to multiple pages of an ID Tag.
Any page(s) can be specified.

Command

SOH	Node No.	Command code	Page designation (8 characters)										Write data								FCS	CR
													Data 1	...	Data 8							
01h		0 3 0 0												...							0DH	

Bit	7	-	0	7	-	3	2	1	0	7	6	-	1	0	7	6	-	2	1	0
Page	Sys	-	Sys	Sys	-	Sys	17	16	15	14	13	-	8	7	6	5	-	1	Sys	Sys
Designation	0*	0*		0*	0*	0*	0/1	0/1	0/1	0/1	0/1	...	0/1	0/1	0/1	0/1	...	0/1	0*	0*
Value	00			00 - 07						00 - FF						00 - FC				

* Always specify 0. If you specify 1 an error (Response code: 14) will occur.

Parameter description

Parameter	Description
Page designation	Pages are specified by setting the bits corresponding to pages that are to be read to 1 and setting the other bits to 0, then converting the result to a hexadecimal character string.
Write data	Specify the write data.

Data Segment Area

Refer to page 129.

Response

The response code (when normal: 00) is returned.

SOH	Node No.	Response code	FCS	CR
01h		0 0		0Dh

Example: Clearing pages 1 to 17 of node No.1 to 0

Command

SOH	Node No.	Command code	Page designation	Write data	FCS	CR
01h	0 1	0 3 0 0	0 0 0 7 F F F C	0 0	0 0	0Dh

Binary notation

0	0	0	0	0	0	0	0	0	0	0	0	0	1	1	1	1	1	1	1	1	1	1	1	1	1	1	1	1	1	1	1	1	1	1	1	1	0	0
---	---	---	---	---	---	---	---	---	---	---	---	---	---	---	---	---	---	---	---	---	---	---	---	---	---	---	---	---	---	---	---	---	---	---	---	---	---	---

Response

SOH	Node No.	Response code	FCS	CR
01h	0 1	0 0	0 1	0Dh

■ Byte Write

Writes data to any specified number of bytes starting from the address specified in the ID Tag.
The maximum number of bytes that can be written at one time is 128.

Command

SOH	Node No.		Command code				First address		Write data				FCS		CR
									Data 1	...	Data n				
01h			0	4	0	0									0Dh

* Data number n = number of bytes written to (2-character units)

Parameter description

Parameter	Description
Address designation	Addresses can be specified in the range 00h to 87h.
Write data	Up to 128 bytes of write data, starting from the specified address, can be specified.

Data Segment Area



Refer to page 129.

Response

The response code (when normal: 00) is returned.

SOH	Node No.		Response code		FCS		CR
01h			0	0			0Dh

Example: Writing to two bytes starting from address 05h of node No.1

Command

SOH	Node No.		Command code				First address		Write data				FCS		CR
									Data 1	Data 2					
01h	0	1	0	4	0	0	0	5	1	2	3	4	0	4	0Dh

Response

SOH	Node No.		Response code		FCS		CR
01h	0	1	0	0	0	1	0Dh

The ID Tag status on normal completion is as shown below.

Page 1						12h	34h	
Page 2								

TEST

Performs a communication test on communications between the host device and Amplifier Unit. When an Amplifier Unit receives a test command, it sends the response code and command test data to the host device as the response.

Command

SOH	Node No.		Command code		Test data						FCS		CR
					Data 1	...	Data n						
01h			1	0									0Dh

* Number of data n < 136 (2-character units)

Parameter description

Parameter	Description
Test data	The data to be sent in the test is specified with a hexadecimal value. (Max. 270 characters) However, note that odd numbers of characters cannot be used.

Response

The response code (when normal: 00) and the received test data are returned.

SOH	Node No.		Response code		Test data						FCS		CR
					Data 1	...	Data n						
01h			0	0									0Dh

Example: Testing by sending the data 12345678 to node No.1

Command

SOH	Node No.		Command code		Test data								FCS		CR
					Data 1	Data 2	Data 3	Data 4	Data 5	Data 6	Data 7	Data 8			
01h	0	1	1	0	1	2	3	4	5	6	7	8	0	8	0Dh

Response

SOH	Node No.		Response code		Test data								FCS		CR
					Data 1	Data 2	Data 3	Data 4	Data 5	Data 6	Data 7	Data 8			
01h	0	1	0	0	1	2	3	4	5	6	7	8	0	9	0Dh

■ NAK

Sends the response made immediately before again.

Command

SOH	Node No.		Command code		FCS		CR
01h			1	2			0Dh

Response

Sends the response made immediately before again.

■ Noise measurement

The levels of noise in the vicinity of the CIDRW Head are measured and the noise level is expressed numerically in the range "00" to "99."

Command

SOH	Node No.		Command code		FCS		CR
01h			4	0			0Dh

Response

The response code (when normal: 00) and the noise level "00" to "99" are returned.

SOH	Node No.		Response code		Noise level	FCS		CR
01h			0	0				0Dh

Influence of background noise on communication distance



Refer to page 128.

■ RESET

All Amplifier Unit processing is stopped, and the initial status is re-established.

Command

SOH	Node No.		Command code		FCS		CR
01h			7	F			0Dh

Response

There is no response to this command.

MEMO

SECTION 5

Troubleshooting

☒ When SECS is Used	92
☒ When SECS is Not Used	98

When SECS is Used

Errors are indicated by the contents of the CIDRW Controller response messages, and by the indicators.

List of Error Messages

When responses are made to messages sent by the CIDRW Controller, errors are expressed by the contents of error messages and the nature of the SSACK response.

S	F	Direction	SECS II names
1	0	S,H←E	Abort Transaction
9	0	S,H→E	Abort Transaction
9	1	S,H←E	Unrecognized Device ID
9	3	S,H←E	Unrecognized Stream Type
9	5	S,H←E	Unrecognized Function Type
9	7	S,H←E	Illegal Data
9	9	S,H←E	Transaction Timer Timeout
9	11	S,H←E	Data Too Long
18	0	S,H←E	Abort Transaction

Controller Indicators

If an error or alarm has occurred at the CIDRW Controller, the LEDs on the front of the Controller light.

Name	Function
OPERATING (green)	Lit when the operation status (status model) of the CIDRW system is operating.
ALARMS (green)	Lit when the status in AlarmStatus of the CIDRW system is Alarm (1).
BUSY (green)	Lit when the status in OperationalStatus of the CIDRW system is BUSY.
ERROR (red)	When a processing error is detected (when SSACK is other than NO), this indicator is lit for 50 ms.

Operation Check Flowchart

Normal Operation Mode

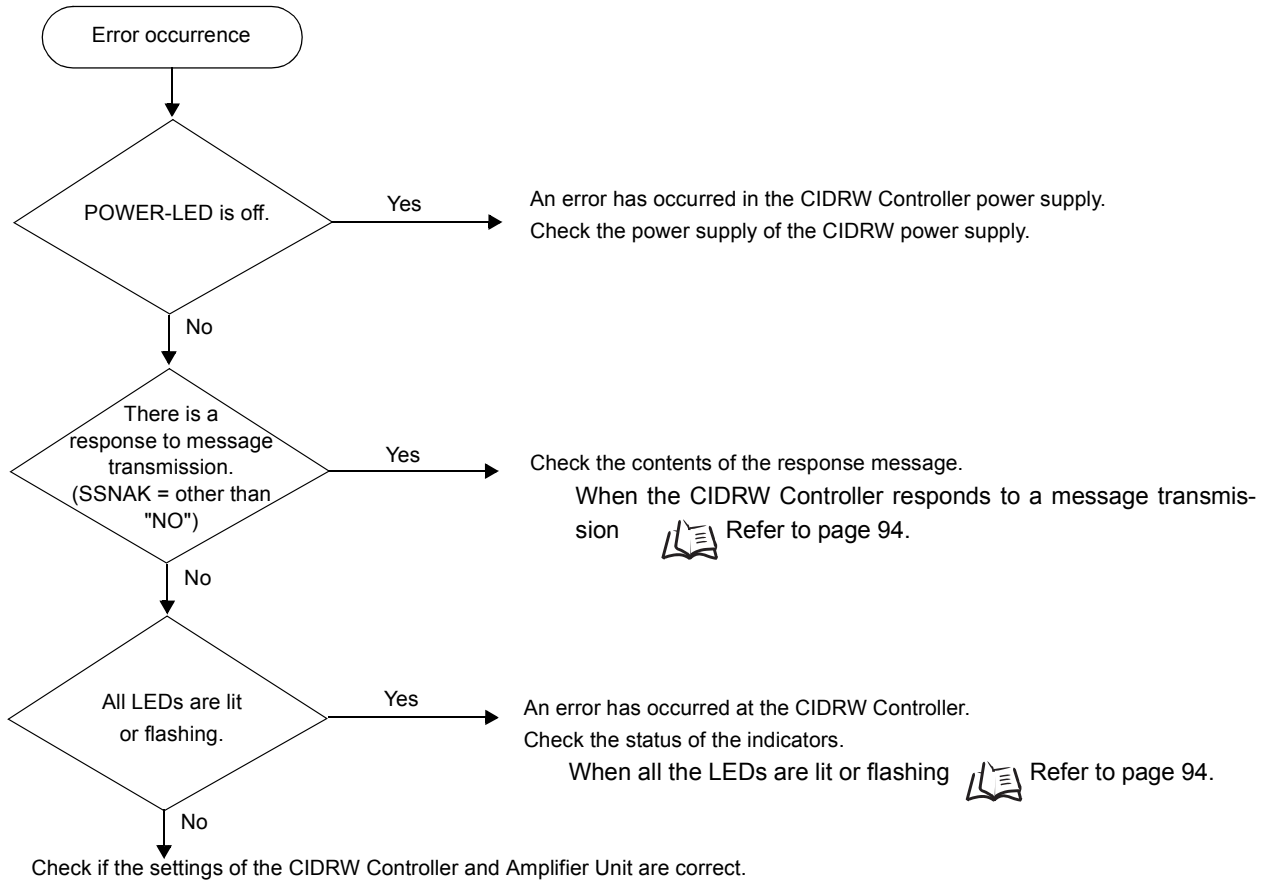

When the CIDRW Controller fails to respond to messages sent to it Refer to page 95.

When an error unrelated to message transmission and responses occurs Refer to page 95.

• Operating normally in the Normal Operation mode

Indicators

POWER	OPERATING	ALARMS	BUSY	ERROR

Response

Response		Function
S	F	
—	—	SSACK="NO"

• **When the CIDRW Controller responds to a message transmission**





















There is a mistake in the message sent to the CIDRW Controller or the Amplifier Unit settings. After taking the appropriate corrective action, restart the Controller and the Amplifier Unit and send the message again.

Response		Main check points
S	F	
—	0	Status conditions when the message was issued (e.g. a Write ID Request message (S18, F11) was sent in the operating mode, or the message was sent during initial processing) Operation Conditions  Refer to page 80.
9	7	Message composition: illegal attributes, insufficient items, etc.
Other than above	Ascertain the cause from the contents of the SSACK response.	
	CE	<ul style="list-style-type: none"> Mistake in the details of the items in the message (The node number of an amplifier that is not set was specified as the TARGET ID, or a segment name that is not set has been specified for DATASEG.) Connection of RS-485 cables between Amplifier Units (failure to detect Amplifier Units) Amplifier Unit baud rate settings (failure to detect Amplifier Units) Node numbers of the Amplifier Units (The same number is set for more than one unit, making detection impossible) Cable routing between the host device and CIDRW Controller (influence of background noise) Noise levels of the power supply line to the CIDRW Controller
	EE	<ul style="list-style-type: none"> Installation distance/inclination between the ID Tag and CIDRW Head Background noise levels of the CIDRW Head Installation spacing in relation to CIDRW Heads connected in other CIDRW systems When the ID read command is executed, the carrier ID contains non-visible ASCII code.
	HE	<ul style="list-style-type: none"> Mistake in the details of the items in the message (A segment that does not match the Amplifier Unit specifications has been set; the response time-out setting is not correct.) Connection and wiring of cable between CIDRW Controller and Amplifier Unit Power supply to Amplifier Units Amplifier Unit terminal resistance settings Routing of each cable (influence of background noise) Node numbers of the Amplifier Units (the same number is set for more than one unit) Amplifier Unit error (hardware error) Noise levels of the power supply line
	TE	<ul style="list-style-type: none"> Type/specifications of the ID Tags used Settings of the ID Tags used (lock, etc.) Environment of use of the ID Tags (ID Tag breakage due to use in unanticipated ways) ID Tag overwrite life

• **When all the LEDs are lit or flashing**

An error has occurred in the CIDRW Controller.

After taking the appropriate corrective action, restart the CIDRW Controller.

POWER	OPERATING	ALARMS	BUSY	ERROR	Main check points
					• Supply of 24 VDC power
					• The CIDRW Controller may be damaged.
					• Mode switch setting (Is the setting 0?) If the error cannot be resolved after checking, the CIDRW Controller may be damaged.
					• The CIDRW Controller may be damaged.

- When the CIDRW Controller fails to respond to messages sent to it

There is a mistake in the CIDRW Controller or Amplifier Unit settings.

After taking the appropriate corrective action, restart the CIDRW Controller and Amplifier Unit.

POWER	OPERATING	ALARMS	BUSY	ERROR	Main check points
					<ul style="list-style-type: none"> • Mode switch setting (Is the setting 0?) • Cable wiring between the CIDRW Controller and host device
					<ul style="list-style-type: none"> • Communications conditions for communication between the CIDRW Controller and host device (baud rate, character composition, etc.) • Cable wiring between the CIDRW Controller and host device
					<ul style="list-style-type: none"> • Node numbers of the Amplifier Units (The same number is set for more than one unit.)

- When an error unrelated to message transmission and responses occurs

There is a mistake in the settings of the CIDRW Controller and Amplifier Unit.

After taking the appropriate corrective action, restart the CIDRW Controller and Amplifier Unit.

POWER	OPERATING	ALARMS	BUSY	ERROR	Main check points
					<ul style="list-style-type: none"> • Mode switch setting (Is the setting 0?) • Amplifier Unit baud rate settings • Node numbers of the Amplifier Units (The same number is set for more than one unit.) • Connection and wiring of cable between CIDRW Controller and Amplifier Unit • Amplifier Unit error (hardware error) • Routing of each cable (influence of background noise)

■ Setting Mode

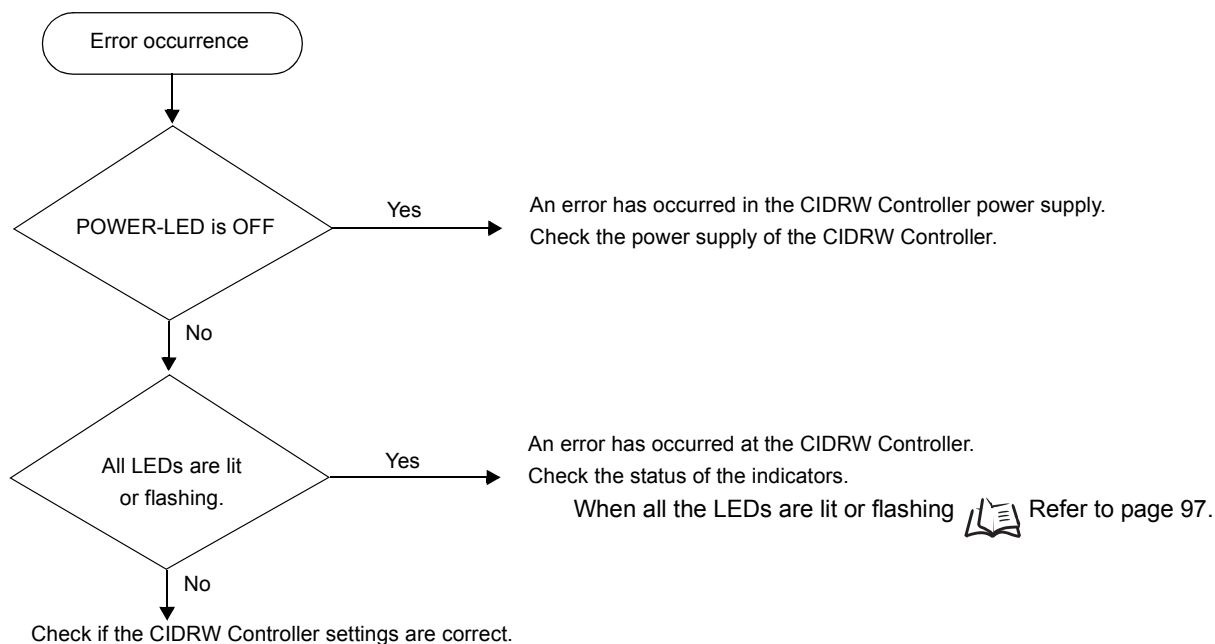

When the CIDRW Controller fails to respond to messages sent to it Refer to page 97.

When an error unrelated to message transmission and responses occurs Refer to page 97.

• Operating normally in the Setting mode

Indicators

POWER	OPERATING	ALARMS	BUSY	ERROR

Terminal initial screen of the host device after startup in the Setting mode

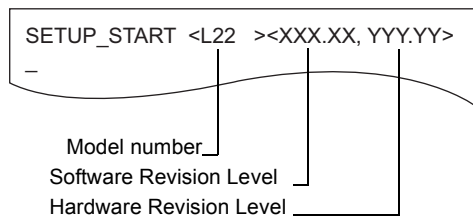

Terminal screen when parameter setting has been completed without error



• When all the LEDs are lit or flashing

An error has occurred in the CIDRW Controller. After taking appropriate corrective action, restart the CIDRW Controller and check the indicators.

POWER	OPERATING	ALARMS	BUSY	ERROR	Main check points
●	●	●	●	●	<ul style="list-style-type: none"> Supply of 24 VDC power
⊗	⊗	⊗	⊗	⊗	<ul style="list-style-type: none"> The CIDRW Controller may be damaged.
⊗	◐	◐	◐	◐	<ul style="list-style-type: none"> Mode switch setting (Is the setting 3?) If the error cannot be resolved after checking, the CIDRW Controller may be damaged.
⊗	⊗	◐	◐	◐	<ul style="list-style-type: none"> The CIDRW Controller may be damaged.

• When the CIDRW Controller responds to a message transmission

There is a mistake in the CIDRW Controller settings or the sent parameters. After taking appropriate corrective action, restart the CIDRW Controller and check the indicators.

POWER	OPERATING	ALARMS	BUSY	ERROR	Main check points
⊗	◐	⊗	⊗	⊗	<ul style="list-style-type: none"> Sent parameters (Are the parameters correct? Are the settings correct?)

Response	Contents
SETUP_FAILED [□]	The parameters are not updated. The figure in square brackets [] indicates the line number where the error was first detected. If a parity error is detected in the received characters, this figure is [0].

• When the CIDRW Controller fails to respond to messages sent to it

There is a mistake in the CIDRW Controller settings or the sent parameters. After taking appropriate corrective action, restart the CIDRW Controller and check the indicators.

POWER	OPERATING	ALARMS	BUSY	ERROR	Main check points
⊗	◐	◐	⊗	●	<ul style="list-style-type: none"> Transmission parameters (Are the parameters correct?) Communications conditions for communication between the CIDRW Controller and the host device (baud rate, character composition, etc.)
⊗	⊗	●	●	●	<ul style="list-style-type: none"> Mode switch setting (Is the setting 3?)

• When an error unrelated to message transmission and responses occurs

There is a mistake in the settings of the CIDRW Controller or Amplifier Unit. After taking appropriate corrective action, restart the CIDRW Controller and Amplifier Unit and check the indicators.

POWER	OPERATING	ALARMS	BUSY	ERROR	Main check points
⊗	⊗	⊗	●	●	<ul style="list-style-type: none"> Mode switch setting (Is the setting 3?)

When SECS is Not Used

Errors are indicated by the presence or absence of a response to an Amplifier Unit command, and by the indicators.

List of Error Messages

Type	Response code	Name	Description
Host communications error	14	Format error	There is a mistake in the command format. (E.g. the command portion is undefined, or the page or address specification is inappropriate.)
Communications error between the CIDRW Head and ID Tag	70	Communications error	Noise or another hindrance has occurred during communication with an ID Tag, and communications cannot be completed normally.
	71	Verification error	Correct data cannot be written to an ID Tag.
	72	No Tag error	Either there is no ID Tag in front of the CIDRW Head, or the CIDRW Head is unable to detect the ID Tag due to environmental factors (e.g. noise).
	7B	Outside write area error	The ID Tag is at a position where reading is possible but writing is not, so writing does not complete normally.
	7E	ID system error (1)	The ID Tag is in a status where it cannot execute the command processing.
	7F	ID system error (2)	An inapplicable ID Tag has been used.

Amplifier Unit Indicators

Name	Indications
RUN (green)	Turns ON when the Amplifier Unit is in normal operation.
COMM (orange)	Turns ON during communications with the host device or during communications with an ID Tag.
NORM (green)	Turns On when the communications finish with no error.
ERROR (red)	Turns ON when an error occurs during communication with the host device, or during communication with an ID Tag.

Operation Check Flowchart

From Installation to Trial Operation

Errors are indicated by whether or not a response to the test command is received and by the status of the Amplifier Unit indicators.

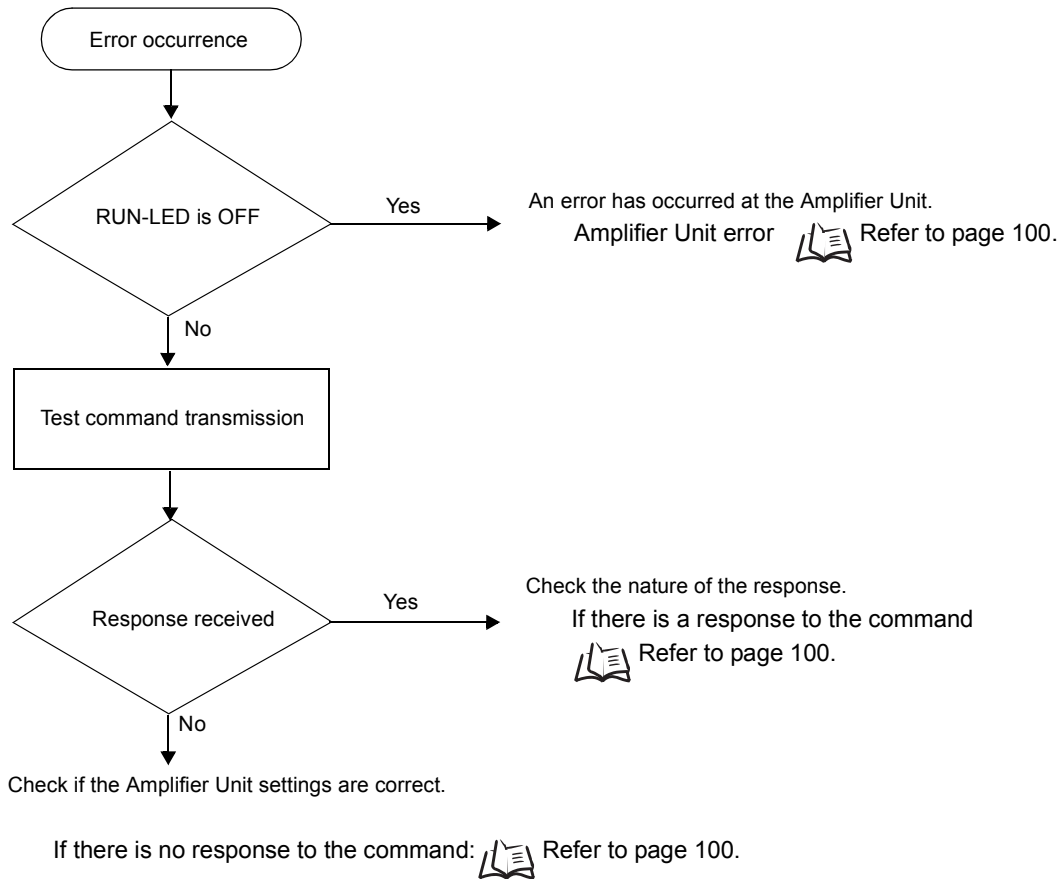

- If the test command was received normally:

Indicators

RUN	COMM	NORM	ERROR

Response code for the response

Type	Response code	Function
Normal	00	The command was received normally.

• **Amplifier Unit error**

Check the status of the indicator LEDs after transmission of the test command.

After taking appropriate corrective action, restart the Amplifier Unit, send the test command again and check again.

RUN	COMM	NORM	ERROR	Main check points
●		—		<ul style="list-style-type: none"> • Influence of background noise (change installation position) • Amplifier Unit power supply If the error cannot be resolved after checking, the Amplifier Unit may be damaged.
(If RUN is OFF, the status of the other indicator LEDs can be ignored.)				

• **If there is no response to the command:**

Check the status of the indicator LEDs after transmission of the test command.

After taking appropriate corrective action, restart the Amplifier Unit, send the test command again and check again.

RUN	COMM	NORM	ERROR	Main check points
☉	●	●	●	<ul style="list-style-type: none"> • Amplifier Unit baud rate settings • Node numbers of the Amplifier Units (do not match the node number in the test command) • Connection and wiring of the cable between the host device and Amplifier Unit • OFF timing of the RS signals between the host device and Amplifier Unit • Routing of each cable (influence of background noise) If the error cannot be resolved after checking, the Amplifier Unit may be damaged.
☉	●	●	☉ (Lights once)	<ul style="list-style-type: none"> • Amplifier Unit baud rate settings • Connection and wiring of the cable between the host device and Amplifier Unit • Routing of the cables (influence of background noise) • OFF timing of the RS signals between the host device and Amplifier Unit • FCS (frame check sequence) calculation method



Method using RS signal control at the host device

In a 1:N connection using Link Units, the RS signals generated from the host device by normal control must be input as CS signals. Turn the RS signals OFF within 15 ms after the completion of data transmission. Correct communications will not be possible without this control.

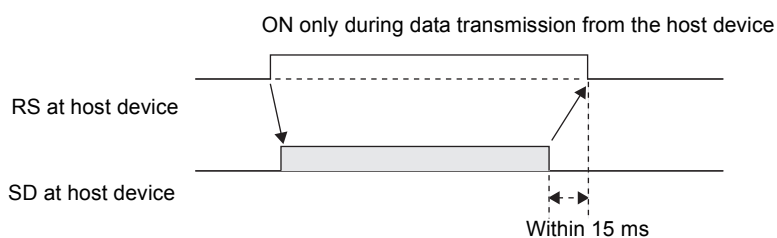

• **If there is a response to the command:**

Check the status of the indicator LEDs after transmission of the test command.

After taking appropriate corrective action, restart the Amplifier Unit, send the test command again and check again.

RUN	COMM	NORM	ERROR	Main check points
☉	☉	●	☉	<ul style="list-style-type: none"> • Node numbers of the Amplifier Units (The same number is set for more than one unit) If the error cannot be resolved after checking, the Amplifier Unit may be damaged.
☉	●	●	☉ (Lights once)	There is a mistake in the command format (number of characters, character code, etc.).

■ From Trial Operation to Communications

Errors are indicated by the status of the indicators after transmission of the write command, and by the response code of the response.

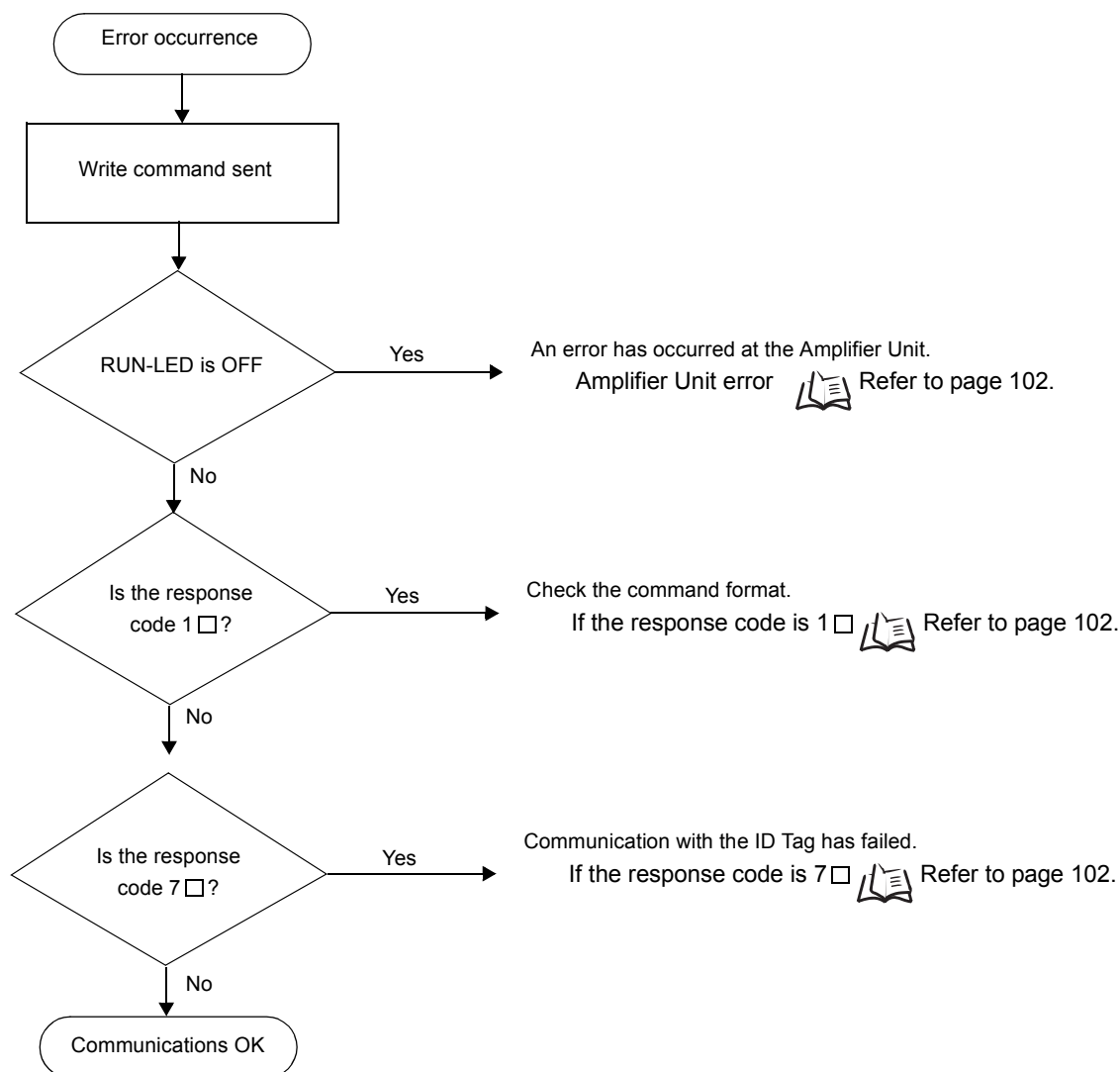

- If the ID Tag was processed normally:

Indicators

RUN	COMM	NORM	ERROR

Response code for the response

Type	Response code	Function
Normal	00	The ID Tag was processed normally.



If there is no response to the write command, refer to the *From Installation to Trial Operation, Operation Check Flowchart*. Refer to page 99.

• **Amplifier Unit error**

Check the status of the indicator LEDs after transmission of the command.

After taking appropriate corrective action, send the write command again and check again.

RUN	COMM	NORM	ERROR	Main check points
●		—		<ul style="list-style-type: none"> • Influence of background noise (Change installation position) • Amplifier Unit power supply <p>If the error cannot be resolved by checking the two points above, the Amplifier Unit may be damaged.</p>
(If RUN is OFF, the status of the other indicator LEDs can be ignored.)				

• **If the response code is 1□:**

There is a host device communications error.

Check the status of the indicator LEDs and the response code of the response after transmission of the command.

After taking appropriate corrective action, send the write command again and check again.

RUN	COMM	NORM	ERROR
☉	●	●	☉ (Lights once)

Response code	Main check points
14	Command format (Command code, page designation, address designation, processed data volume, etc.)

• **If the response code is 7□:**

There is a communications error in communication between the CIDRW Head and ID Tag.

Check the status of the indicator LEDs and the response code of the response after transmission of the command.

After taking appropriate corrective action, send the write command again and check again.

RUN	COMM	NORM	ERROR
☉	☉ (Lights once)	●	☉ (Lights once)

Response code	Main check points
70	<ul style="list-style-type: none"> • Background noise levels of the CIDRW Head (Check the surroundings with the environmental noise level measurement function) • Distance to another CIDRW Head • Influence of background noise (Change installation position) <p>If the error cannot be resolved after checking, the Amplifier Unit may be damaged.</p>
71	<ul style="list-style-type: none"> • ID Tag overwrite life (Replace the ID Tag) • Environment of use of the ID Tags (ID Tag breakage due to use in unanticipated ways)
72	<ul style="list-style-type: none"> • Connection to the CIDRW Head • Distance between the ID Tag and CIDRW Head • CIDRW Head background noise levels (Check the surroundings with the environmental noise level measurement function) • Distance to another CIDRW Head
7B	<ul style="list-style-type: none"> • Distance between the ID Tag and CIDRW Head • Background noise levels of the CIDRW Head (Check the surroundings with the environmental noise level measurement function) • Distance to another CIDRW Head • Influence of background noise (Change installation position)
7E	<ul style="list-style-type: none"> • Type/specifications of the ID Tags used
7F	<ul style="list-style-type: none"> • Settings of the ID Tags used (The ID Tag lock function is used.*) • Environment of use of the ID Tags (ID Tag breakage due to use in unanticipated ways)

* The ID Tag has a lock function, but the amplifier unit has no function for locking an ID Tag.

SECTION 6

Appendix

☒ Specifications and Dimensions	104
☒ System Configuration Examples	108
☒ When SECS is Not Used	109
☒ Characteristic Data depending on Conditions of Use	110
☒ Data Segment Area	129
☒ Regular Inspection	130
☒ SECS Protocol Specifications	131
☒ ASCII Code Table	136
☒ Protective Construction	137

Specifications and Dimensions

Controller
V700-L22

(Unit: mm)

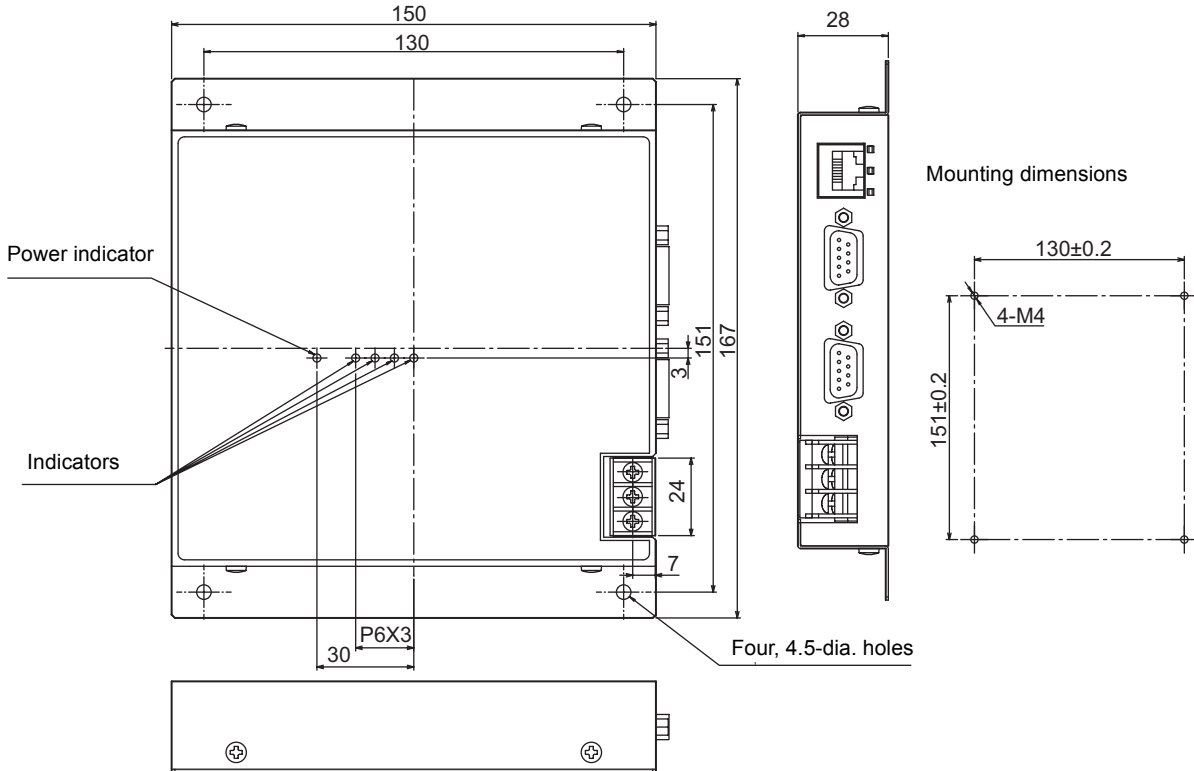

Item	Specifications
Power supply voltage	24 VDC +10% -15%
Current consumption	150 mA max. (inrush current: approx. 10 A max.)
Ambient temperature	Operating: 0 to +40°C Storage: -15 to +65°C (with no icing)
Ambient humidity	Operating: 10% to 85% Storage: 10% to 95% (with no condensation)
Degree of protection	IP20 (IEC60529)
Insulation resistance	50 MΩ min. between power supply terminals and the frame ground terminal (500 VDC M)
Dielectric strength	Leak current not to exceed 3.5 mA on application of 500 VAC (50/60 Hz for 1 minute) between both power supply terminals and the frame ground terminal
Vibration resistance	Frequency: 10 to 150 Hz; double amplitude: 0.20 mm; acceleration: 15 m/s ² for 8 minutes, 10 times each in X, Y, and Z directions
Shock resistance	Shock of 150 m/s ² in X, Y, and Z directions, 3 times each for 18 repetitions
Ground	Ground to 100 Ω or less.
Case material	SECC (coating)
Weight	Approx. 580 g

Amplifier Unit
V640-HAM11-V2

(Unit: mm)

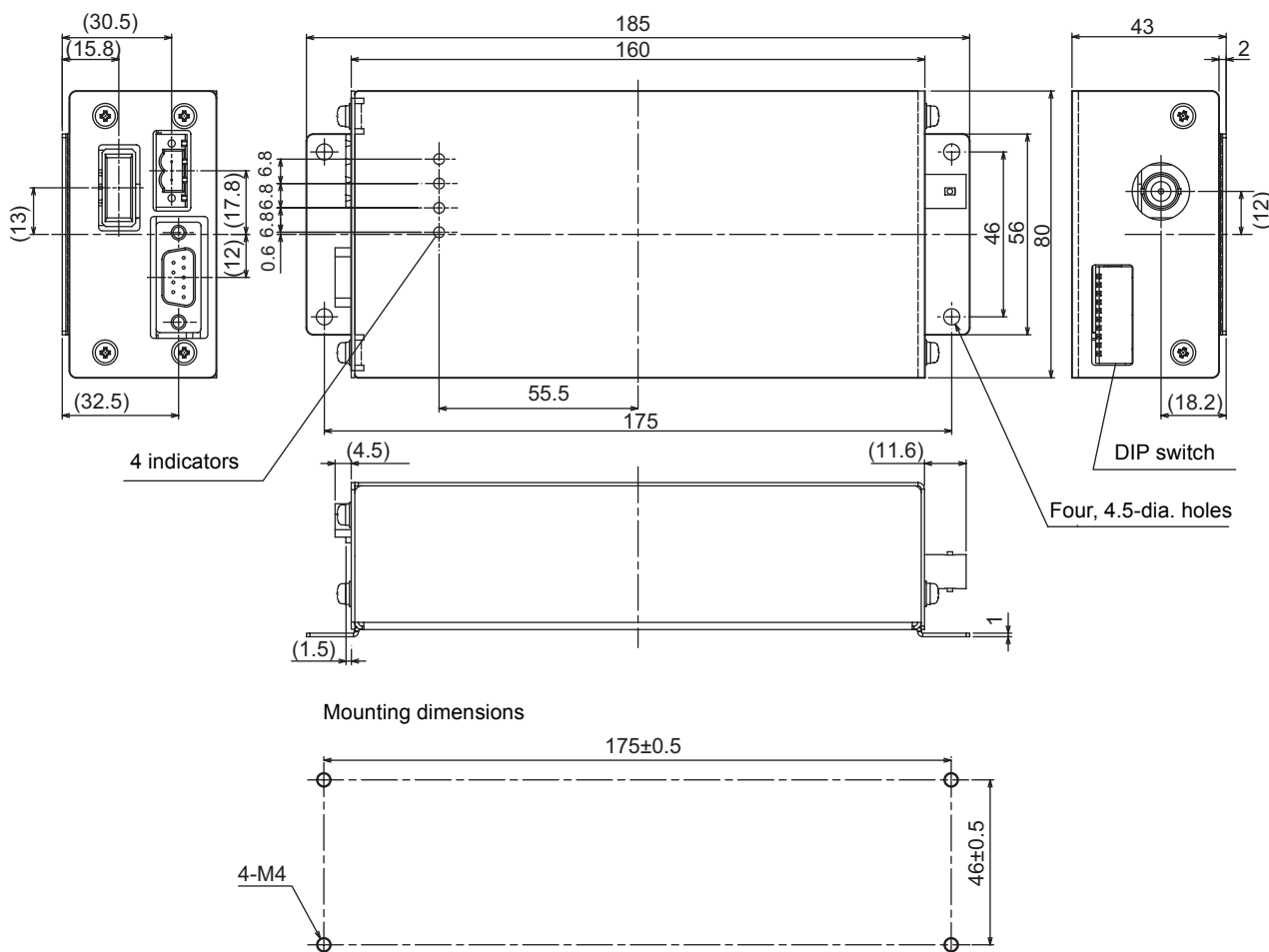

Item	Specifications
Power supply voltage	24 VDC +10% -15%
Current consumption	150 mA max.
Ambient temperature	Operating: 0 to +40°C Storage: -15 to +65°C (with no icing)
Ambient humidity	Operating/Storage: 35% to 85% (with no condensation)
Degree of protection	IP20 (IEC60529 standard)
Insulation resistance	20 MΩ min. between power supply terminals and the frame ground terminal (100 VDC M)
Dielectric strength	Leak current not to exceed 5 mA on application of 1000 VAC (50/60 Hz for 1 minute) between both power supply terminals and the frame ground terminal
Vibration resistance	Frequency: 10 to 150 Hz; double amplitude: 0.20 mm; acceleration: 15 m/s ² for 8 minutes, 10 times each in X, Y, and Z directions
Shock resistance	Shock of 150 m/s ² in X, Y, and Z directions, 3 times each for 18 repetitions
Ground	Ground to 100 Ω or less.
Case material	SECC (coating)
Weight	Approx. 500 g

CIDRW Head
V640-HS61

(Unit: mm)

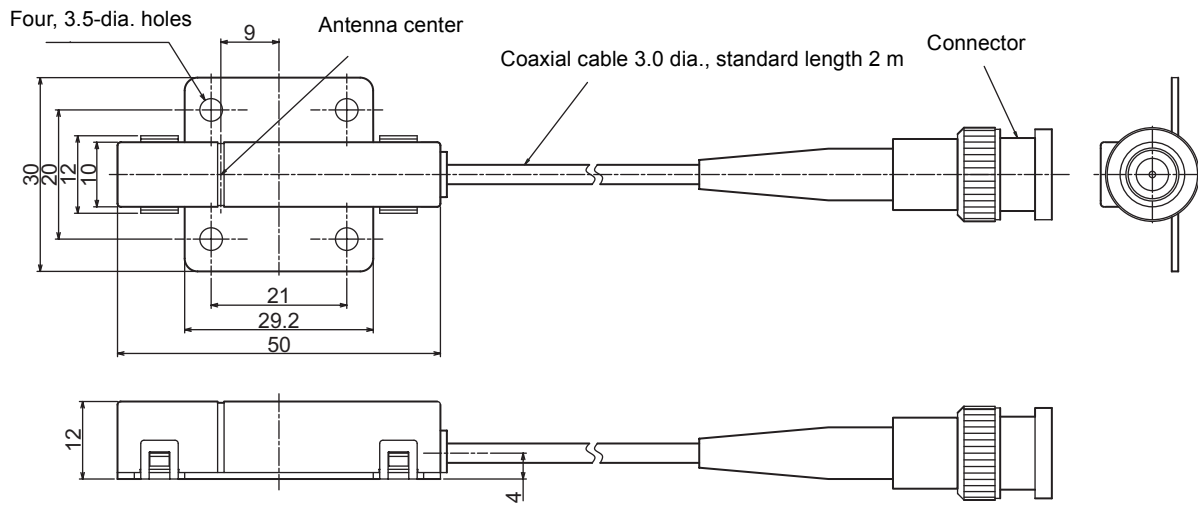

Mounting dimensions

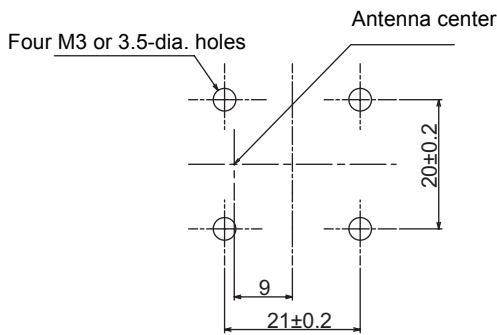

Item	Specifications
Transmission frequency	134 kHz
Ambient temperature	Operating: 0 to +40°C Storage: -15 to +65°C (with no icing)
Ambient humidity	Operating/Storage: 35% to 85% (with no condensation)
Degree of protection	IP60 (IEC60529)
Insulation resistance	20 MΩ min. between all terminals and the case (100 VDC M)
Dielectric strength	Leak current not to exceed 5 mA on application of 1000 VAC (50/60 Hz for 1 minute) between all terminals and the case
Vibration resistance	Frequency: 10 to 150 Hz; double amplitude: 0.20 mm; acceleration: 15 m/s ² for 8 minutes, 10 times each in X, Y, and Z directions
Shock resistance	Shock of 150 m/s ² in X, Y, and Z directions, 3 times each for 18 repetitions
Casing material	ABS/epoxy resin Stainless steel mount
Weight	Approx. 70 g
Cable length	2 m
Cable specification	3-mm-dia. coaxial cable

Link Unit
V700-L11

(Unit: mm)

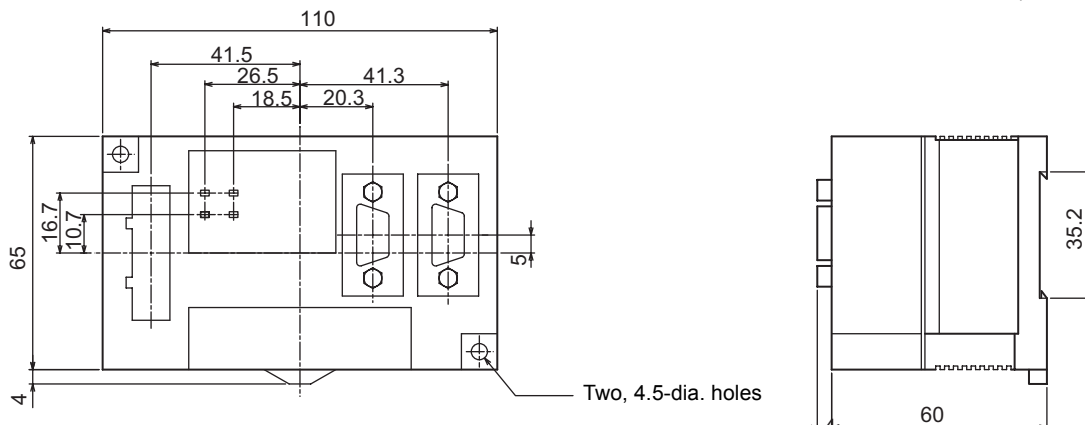

Mounting dimensions

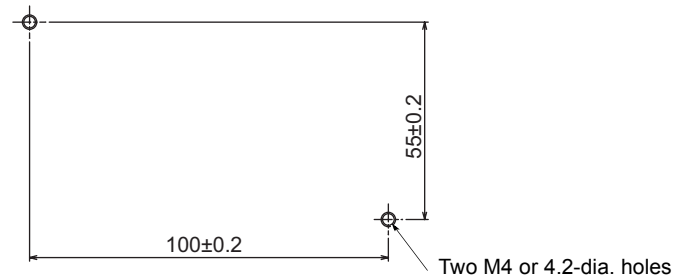

Item	Specifications
Power supply voltage	24 VDC +10% -15%
Current consumption	250 mA max. (inrush current: approx. 10 A)
Ambient temperature	Operating: 0 to +40°C Storage: -15 to +50°C (with no icing)
Ambient humidity	Operating/Storage: 35% to 85% (with no condensation)
Degree of protection	IP20 (IEC60529)
Insulation resistance	50 MΩ min. between power supply terminals and the frame ground terminal (500 VDC M)
Dielectric strength	Leak current not to exceed 5 mA on application of 1000 VAC (50/60 Hz for 1 minute) between power supply terminals and the frame ground terminal
Vibration resistance	Frequency: 10 to 150 Hz; double amplitude: 0.20 mm; acceleration: 15 m/s ² for 8 minutes, 10 times each in X, Y, and Z directions
Shock resistance	Shock of 150 m/s ² in X, Y, and Z directions, 3 times each for 18 repetitions
Ground	Ground to 100 Ω or less.
Case material	PC/ABS resin
Weight	Approx. 200 g

System Configuration Examples

When SECS is Used

Communication with the host device is possible using the SECS protocol.

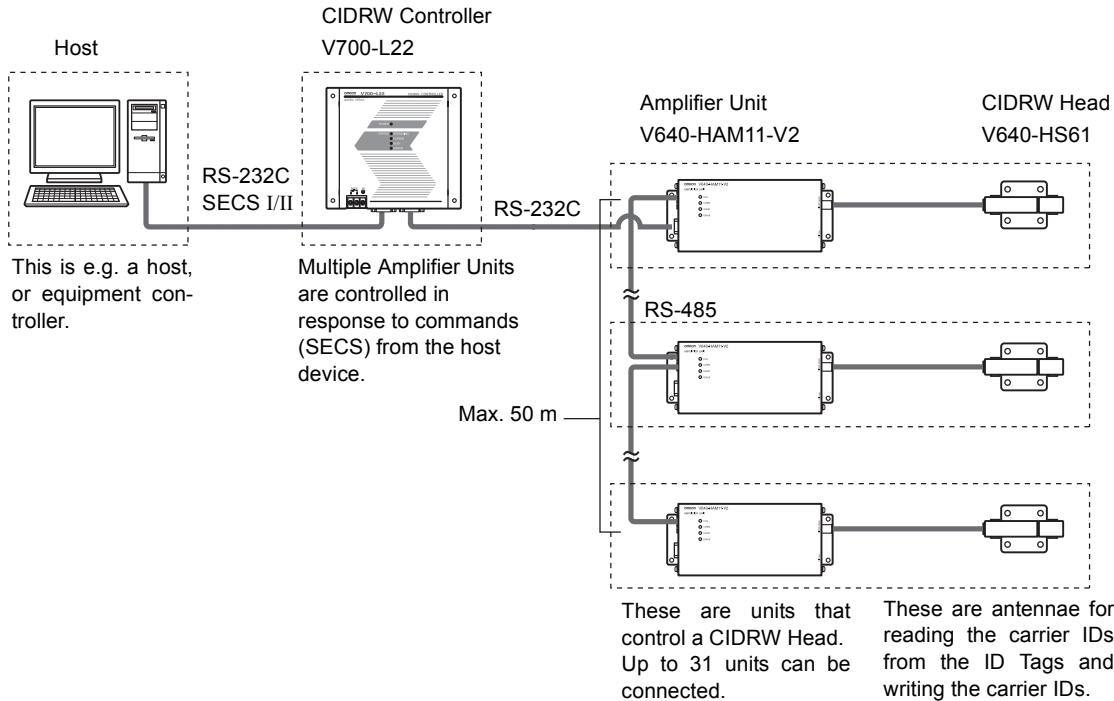

With the above system configuration, the Amplifier Unit connected directly to the CIDRW Controller converts signals from RS-232C to RS-485. If this Amplifier Unit is removed, communications will not be possible with the other Amplifier Units. If the Amplifier Unit connected directly to the CIDRW Controller must be removed while the system is operating, insert a Link Unit (V700-L11) between the CIDRW Controller and the first Amplifier Unit. If an Amplifier Unit on the end of the network is removed, be sure to turn ON the terminating resistance on the Amplifier Unit that will end up on the end of the network while the Amplifier Unit is removed.

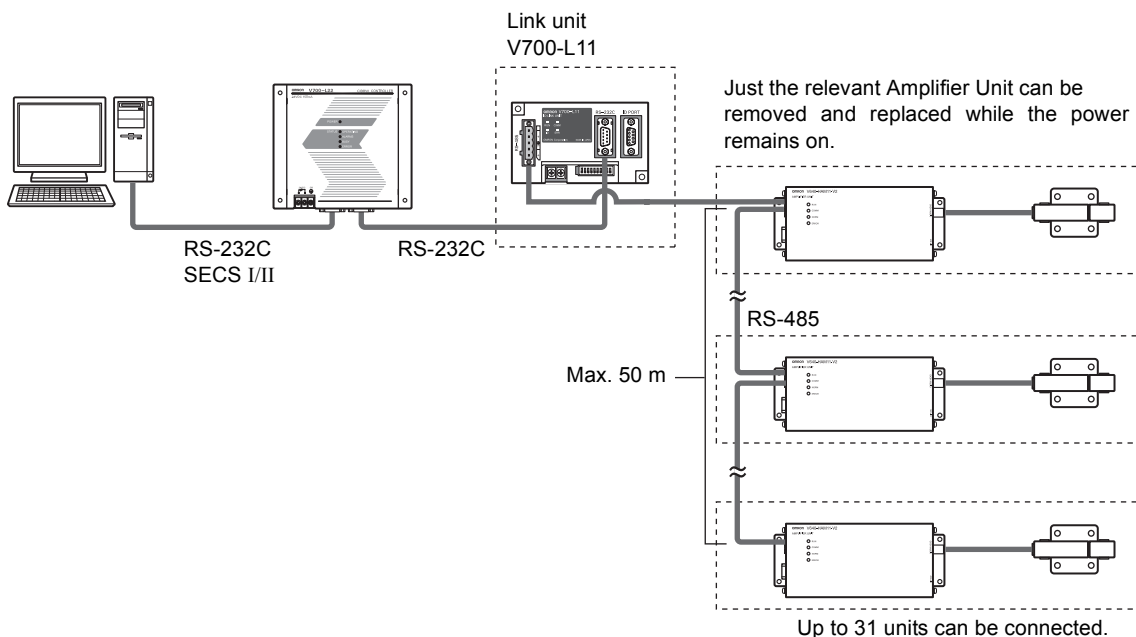

When SECS is Not Used

Communications with the host device follow the OMRON proprietary protocol.
The Amplifier Units are connected directly to the host device without using a CIDRW Controller.

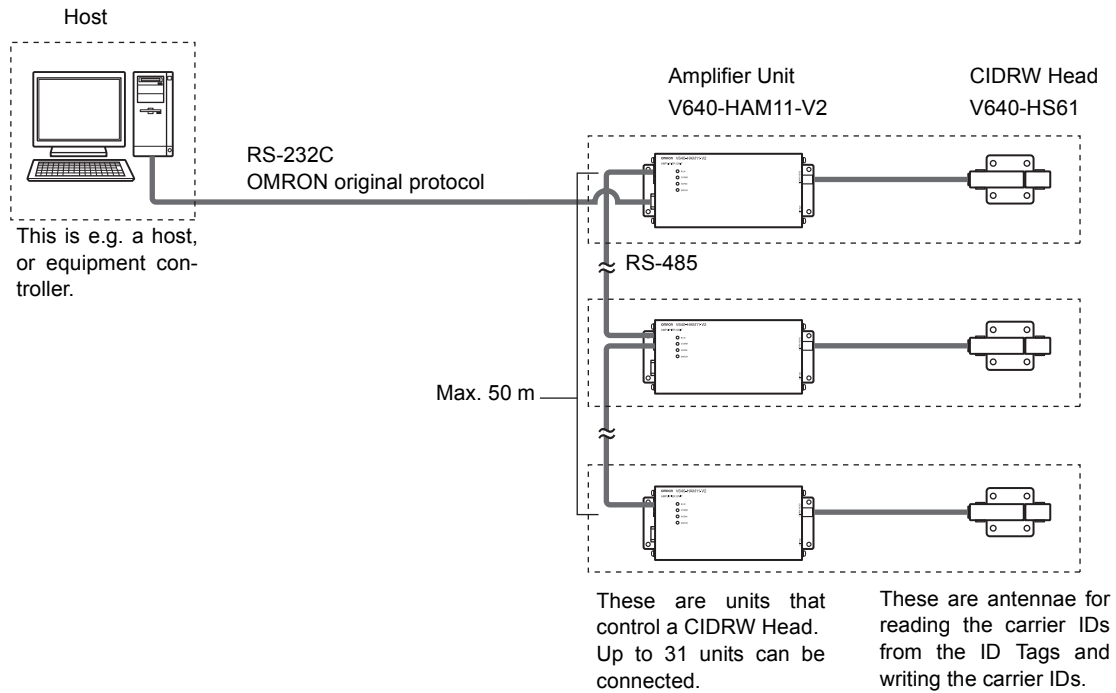

With the above system configuration, the Amplifier Unit connected directly to the CIDRW Controller converts signals from RS-232C to RS-485. If this Amplifier Unit is removed, communications will not be possible with the other Amplifier Units. If the Amplifier Unit connected directly to the CIDRW Controller must be removed while the system is operating, insert a Link Unit (V700-L11) between the CIDRW Controller and the first Amplifier Unit. If an Amplifier Unit on the end of the network is removed, be sure to turn ON the terminating resistance on the Amplifier Unit that will end up on the end of the network while the Amplifier Unit is removed.

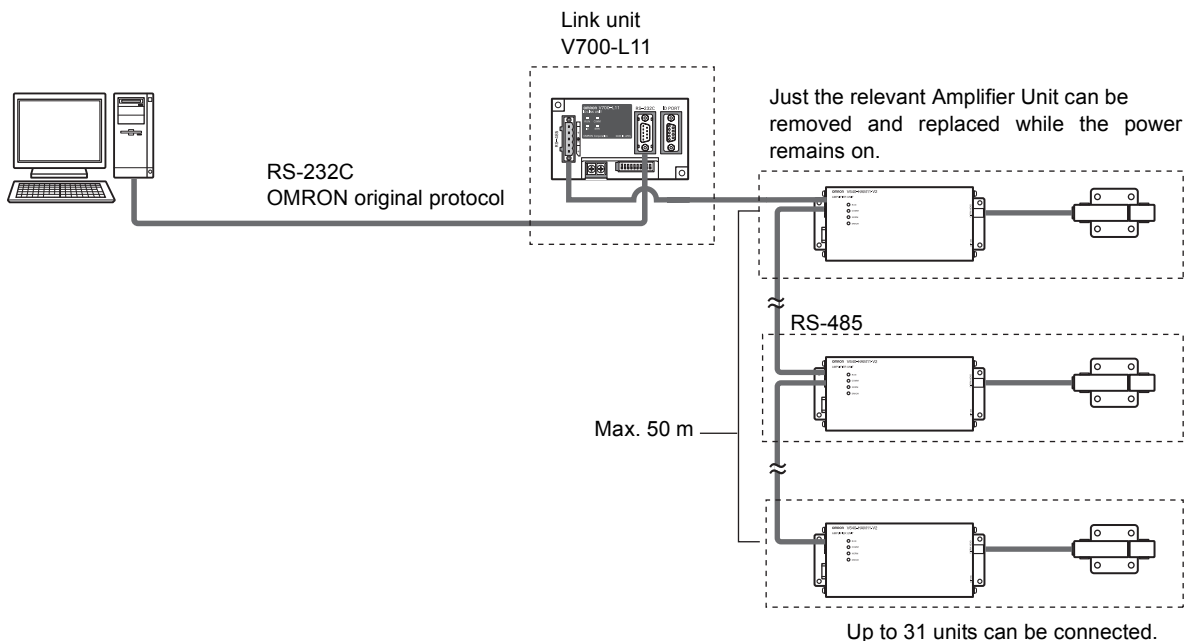

Characteristic Data depending on Conditions of Use

Maps of Communications Areas (Reference Only)

The figures given below for communications areas (communications distances) are reference values only and cannot be guaranteed.

The maps of communications areas will vary according to the ID tags that you use, the background metals, the ambient noise, the effects of temperature and so on, and should be thoroughly confirmed on installation. The V640-HAM11-V2 can transmit data to and from either the RI-TRP-DR2B or RI-TRP-WR2B.

Coaxial Mounting (RI-TRP-DR2B)

- READ

Communications Areas (READ)

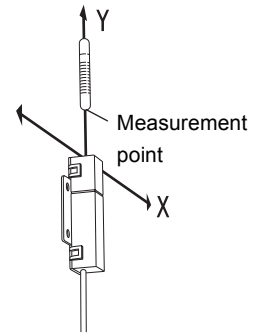
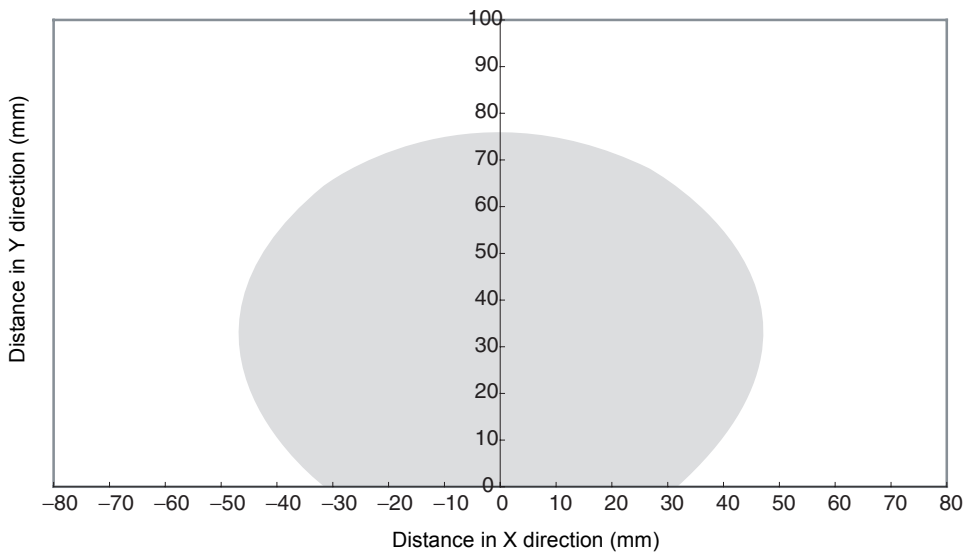

- WRITE

Communications Areas (WRITE)

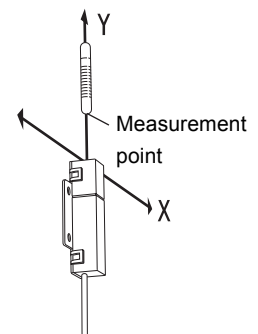
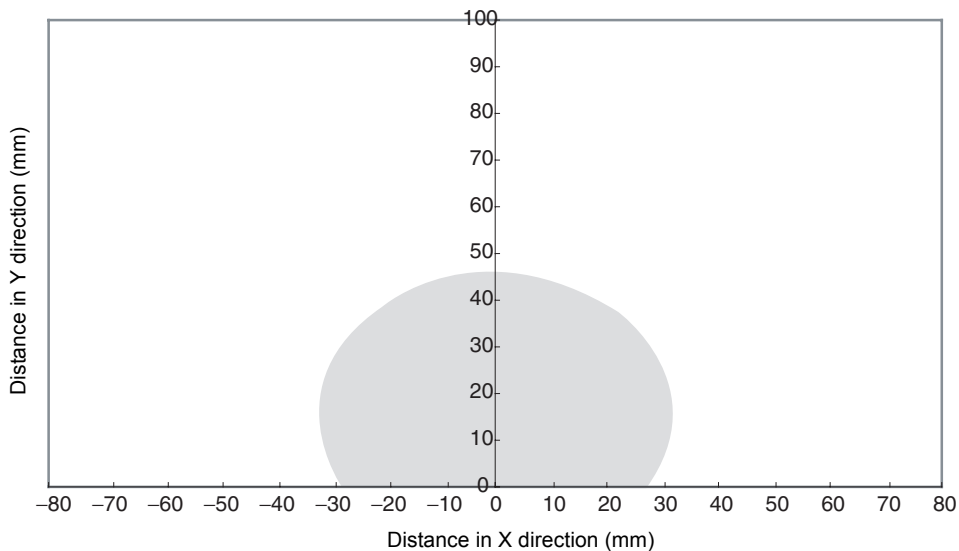

■ Coaxial Mounting (RI-TRP-DR2B)

- READ

Communications Areas (READ)

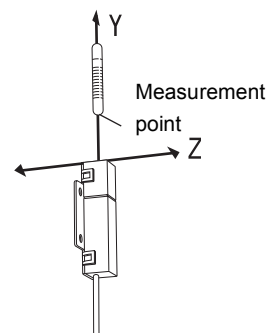
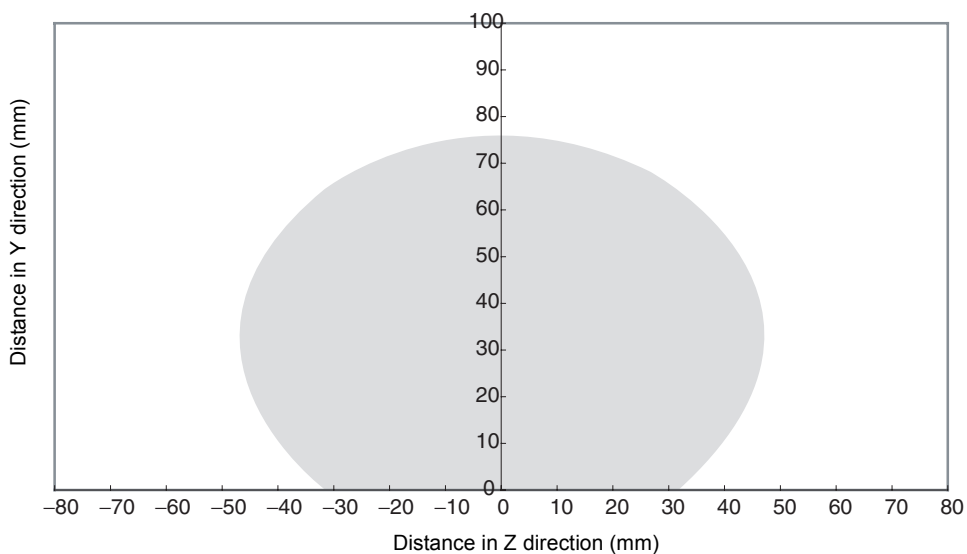

- WRITE

Communications Areas (WRITE)

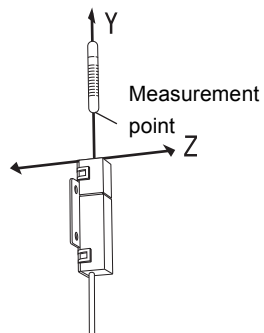
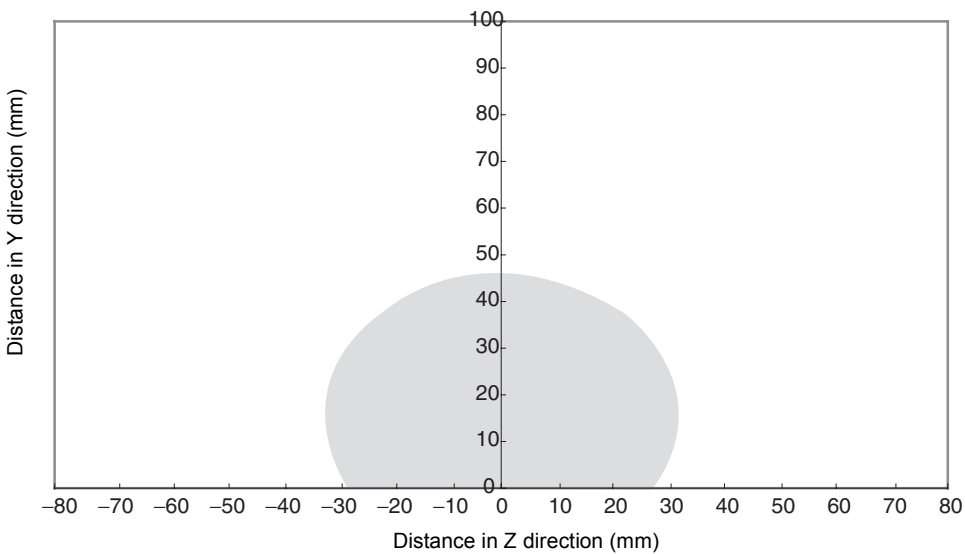

■ Parallel Mounting (RI-TRP-DR2B)

- READ

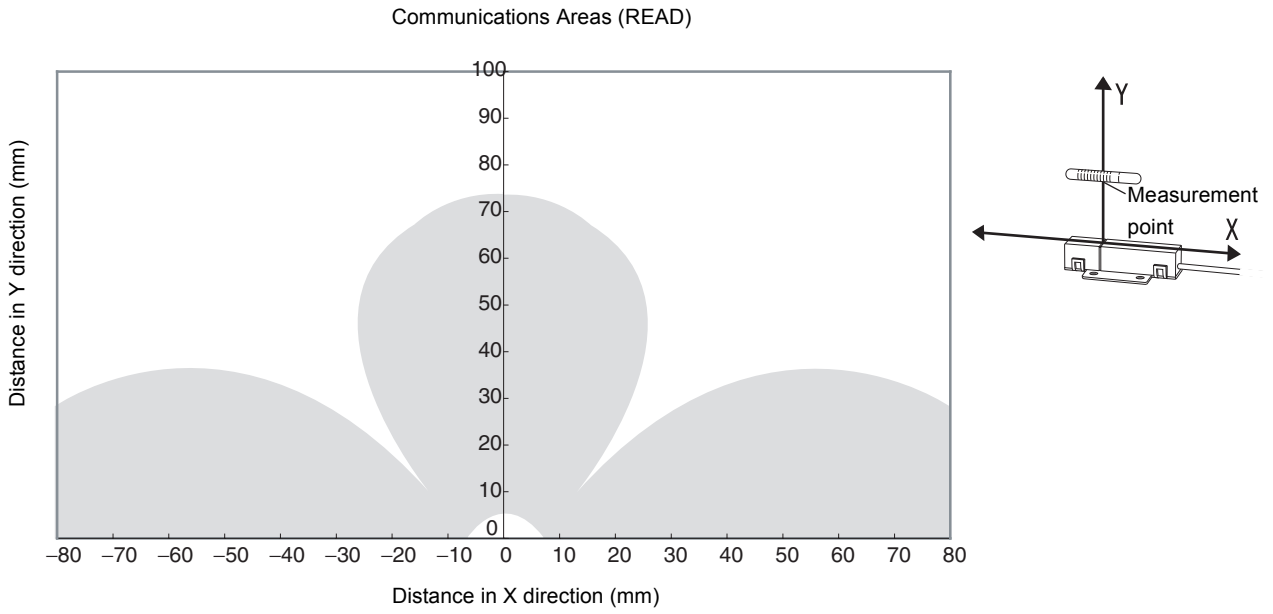

- WRITE

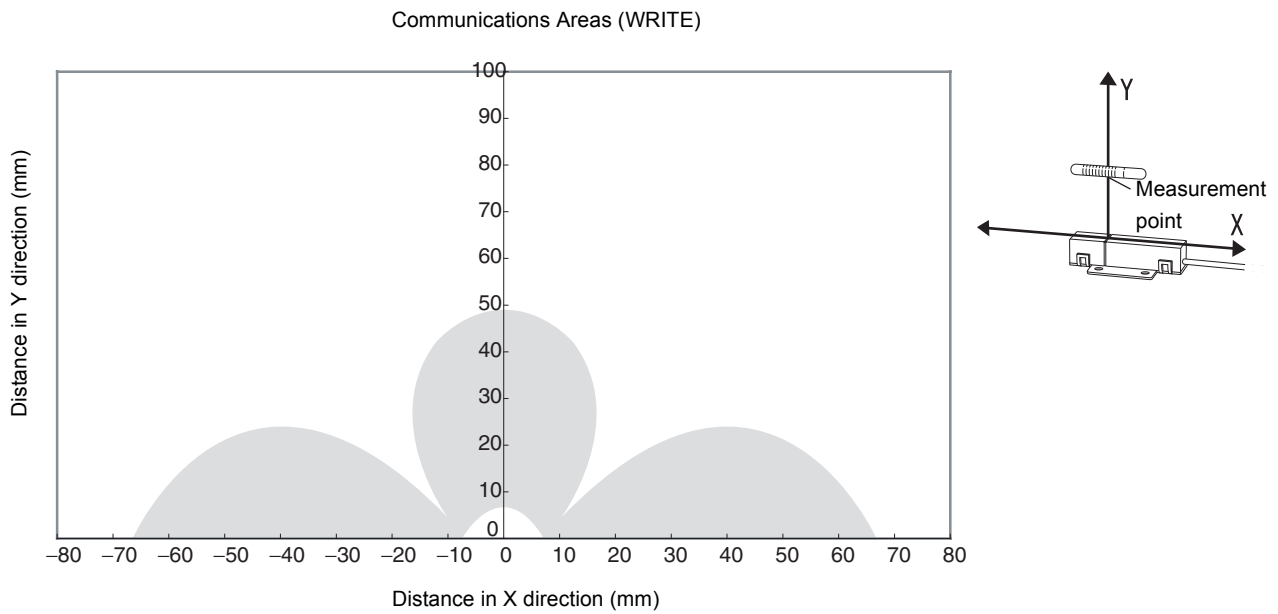

■ Parallel Mounting (RI-TRP-DR2B)

- READ

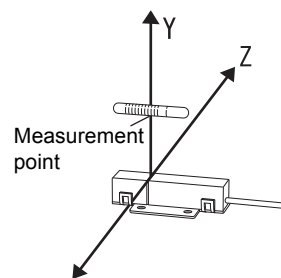
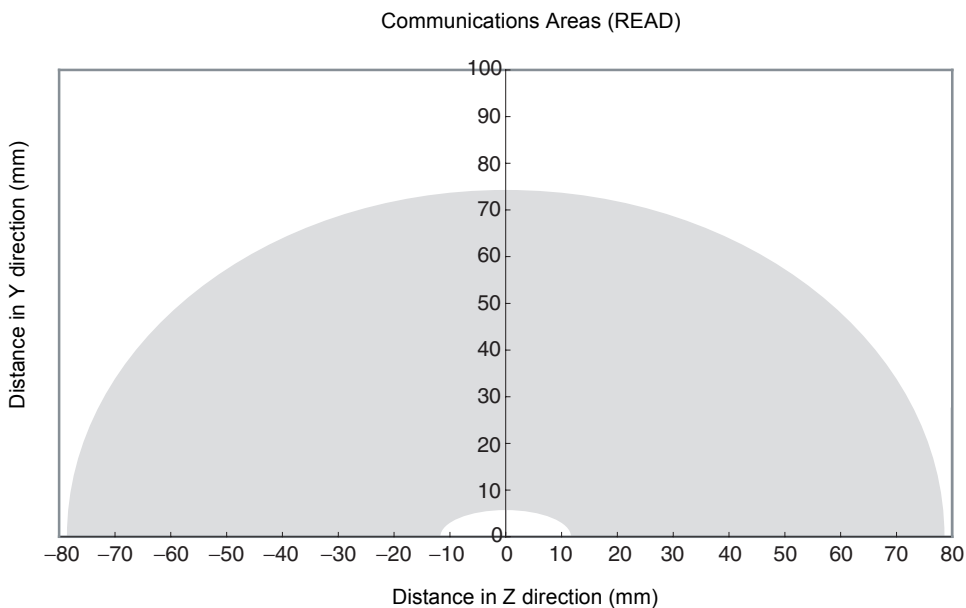

- WRITE

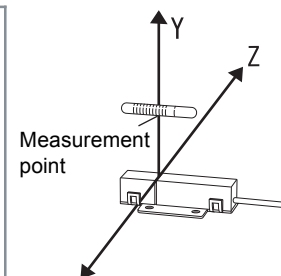
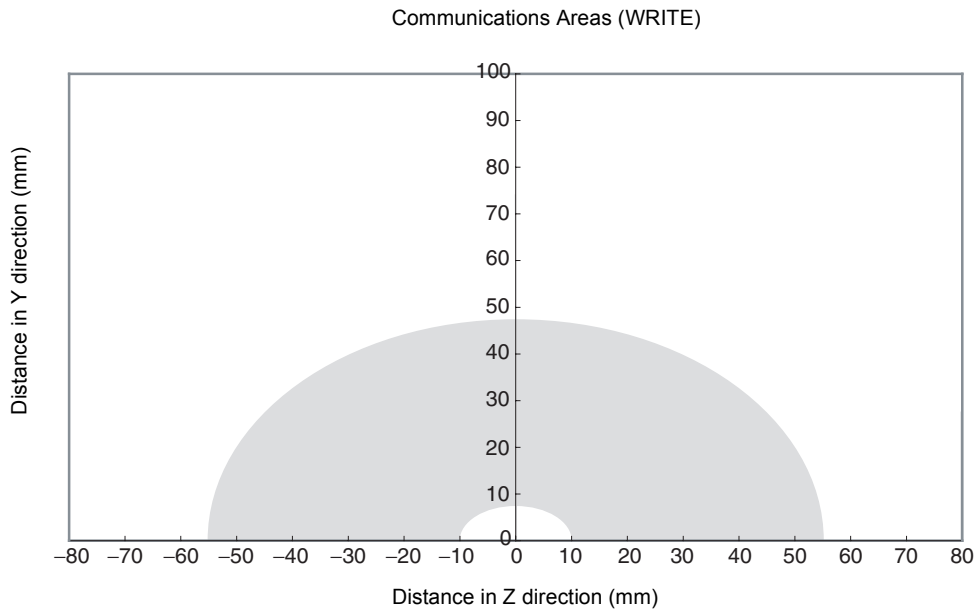

■ Vertical Mounting (RI-TRP-DR2B)

- READ

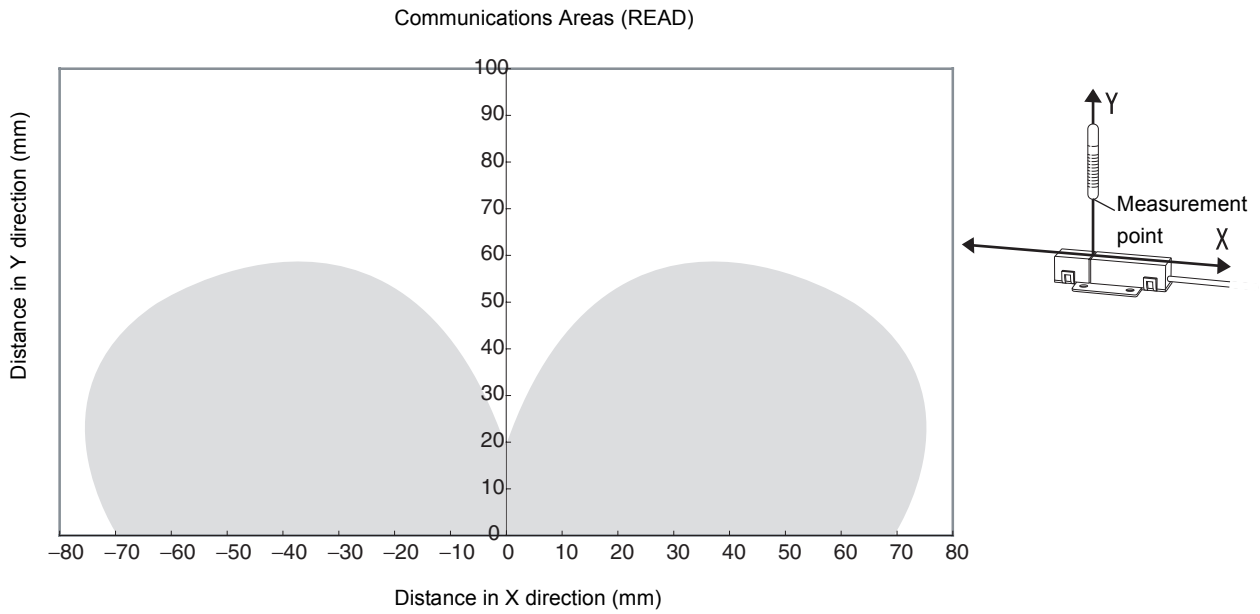

- WRITE

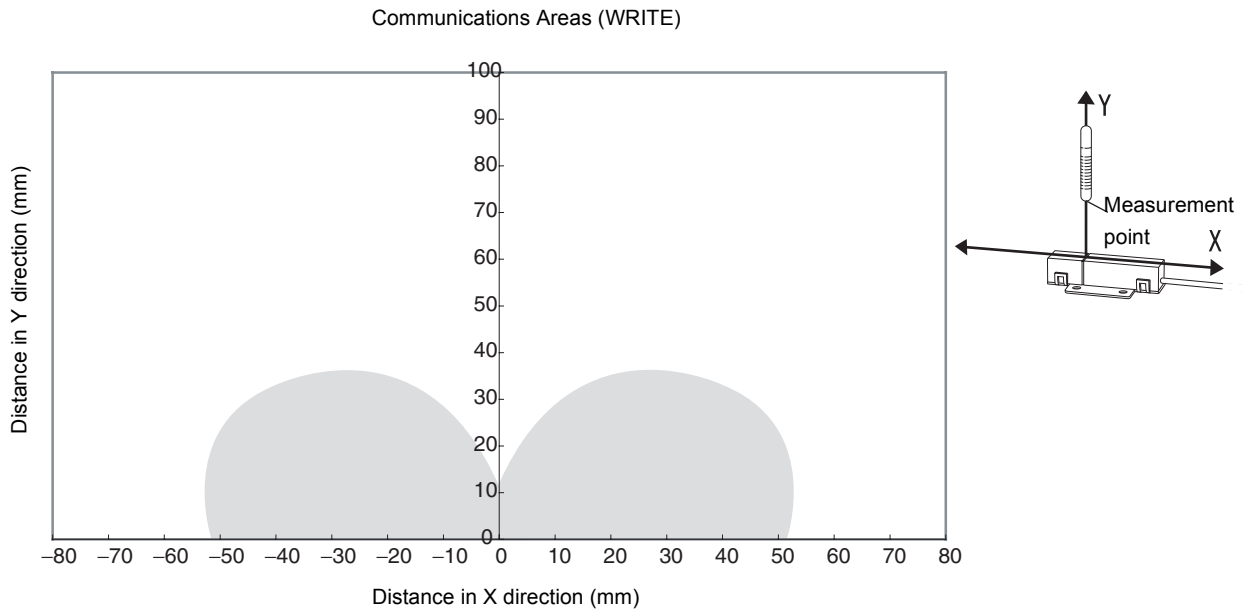

■ Vertical Mounting (RI-TRP-DR2B)

- READ

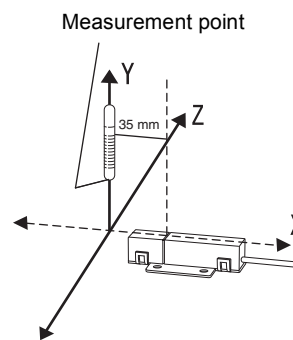
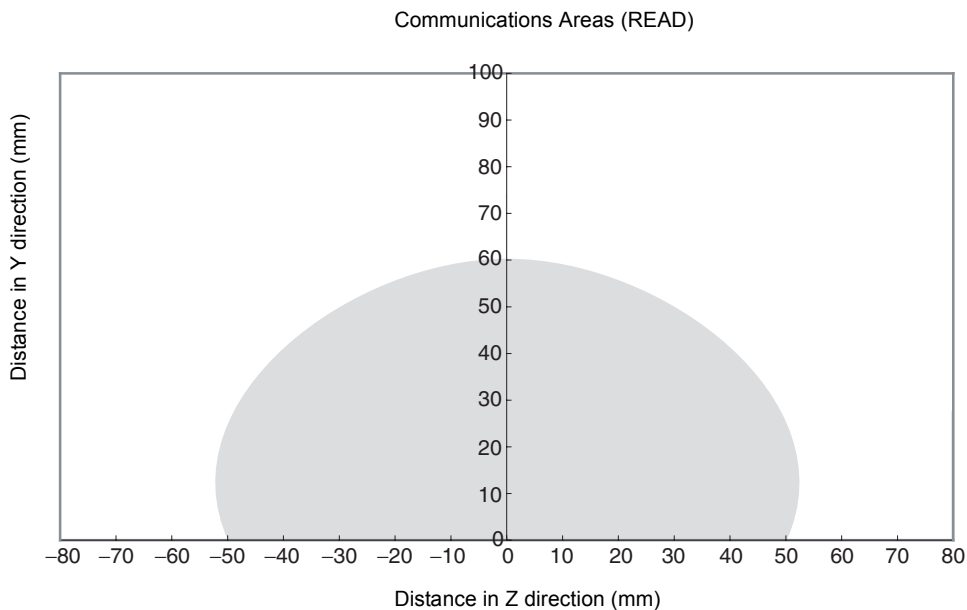

- WRITE

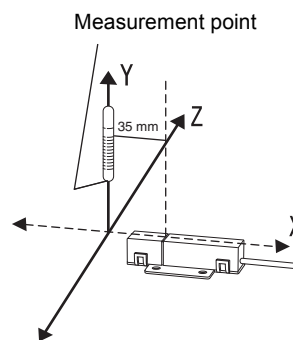
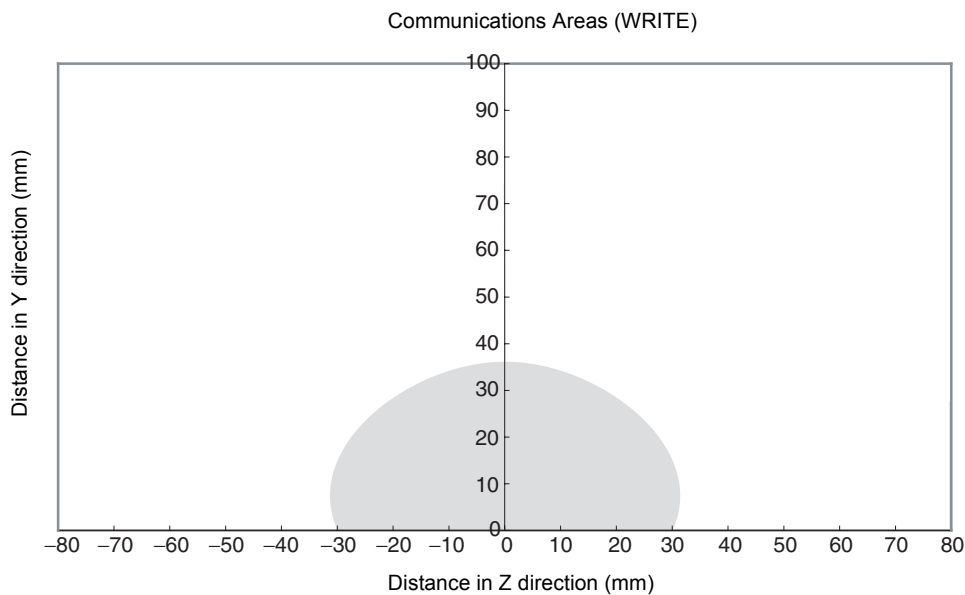

■ Coaxial Mounting (RI-TRP-WR2B)

- READ

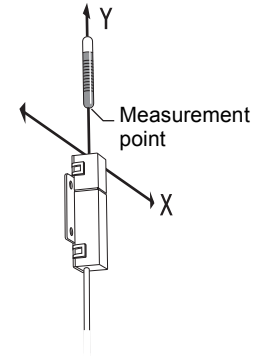
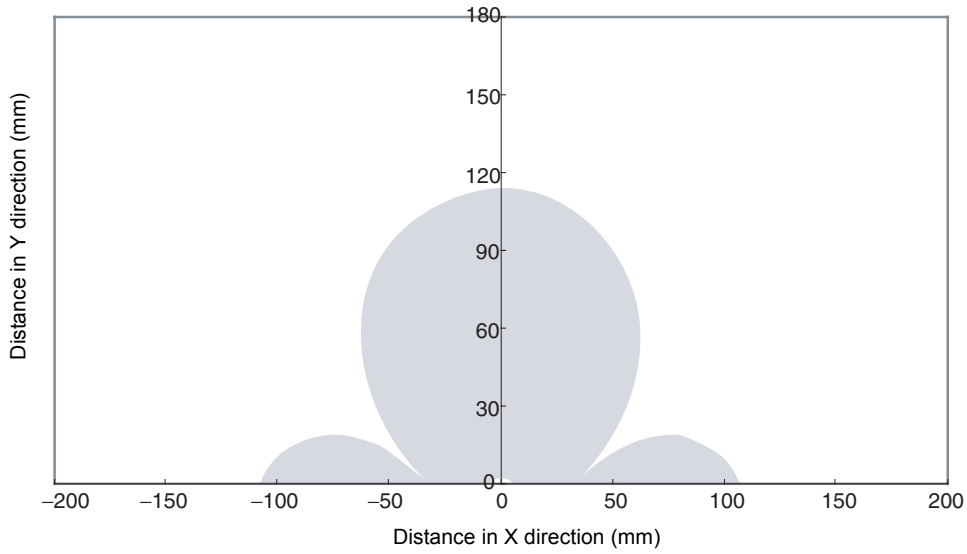

- WRITE

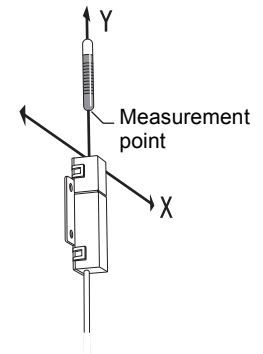
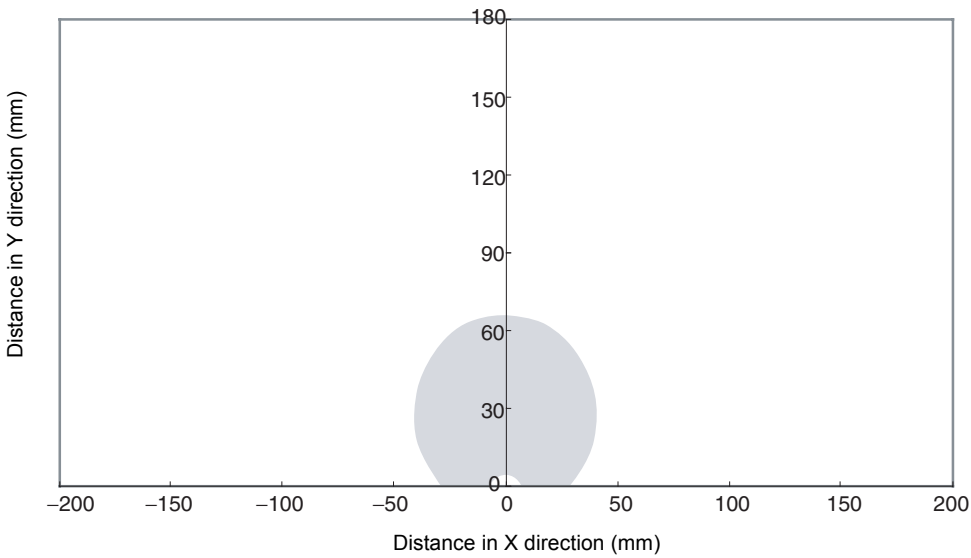

■ Coaxial Mounting (RI-TRP-WR2B)

- READ

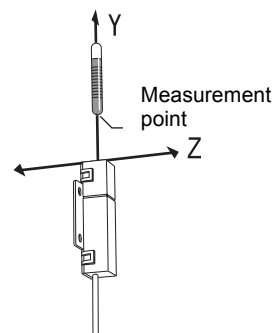
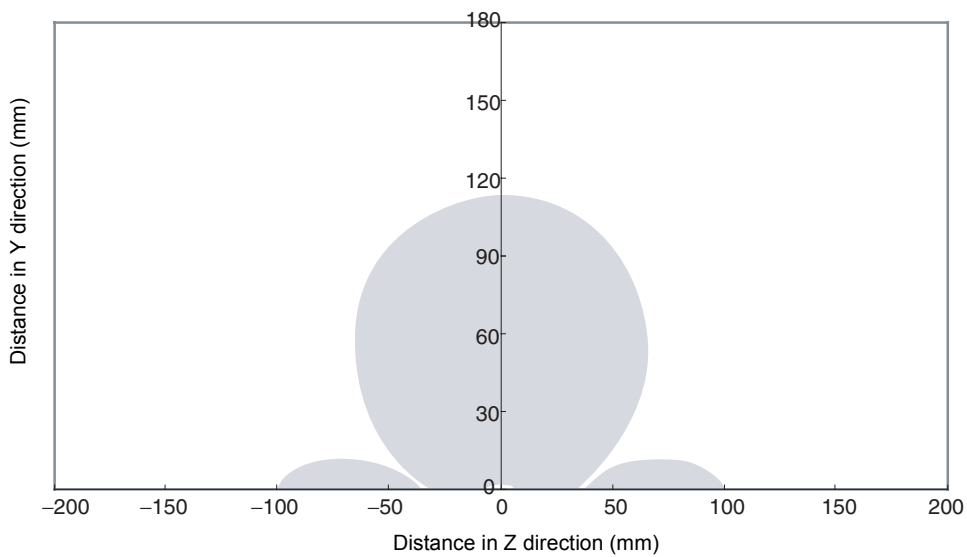

- WRITE

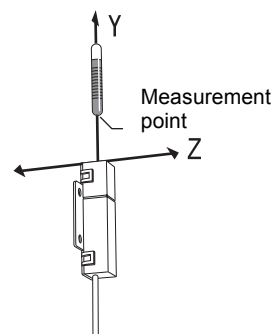
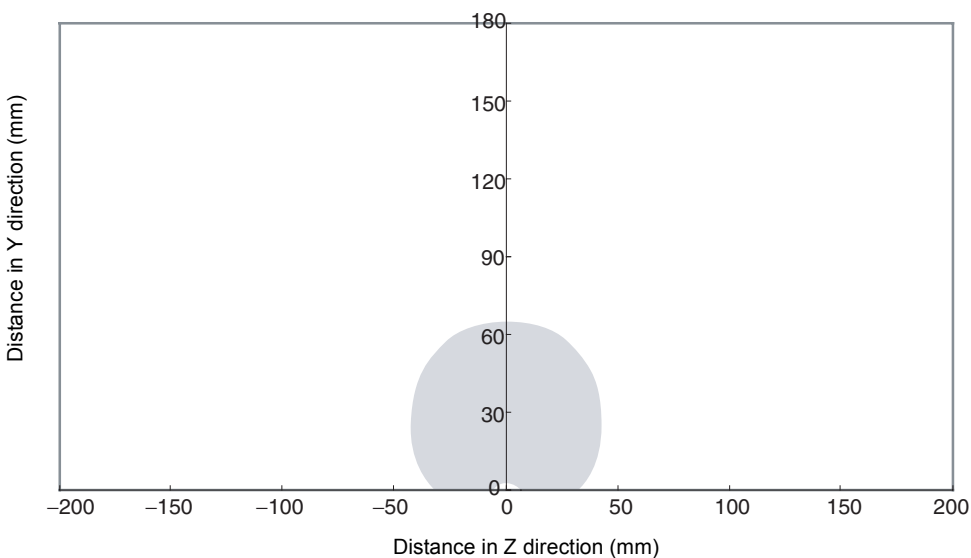

■ Parallel Mounting (RI-TRP-WR2B)

- READ

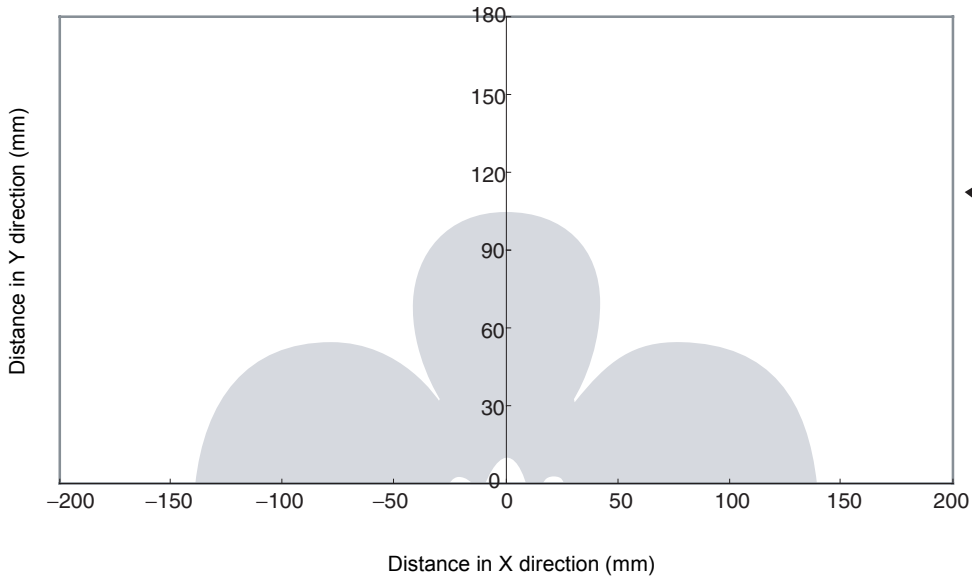

- WRITE

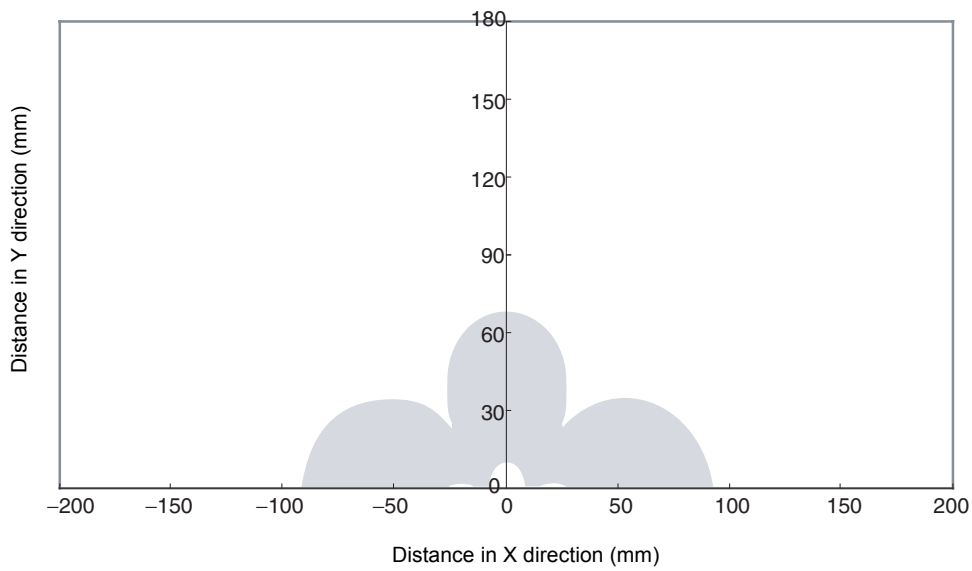

■ Parallel Mounting (RI-TRP-WR2B)

- READ

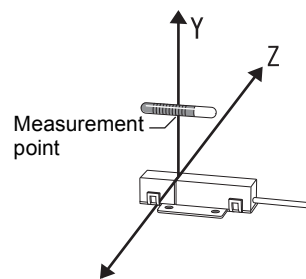
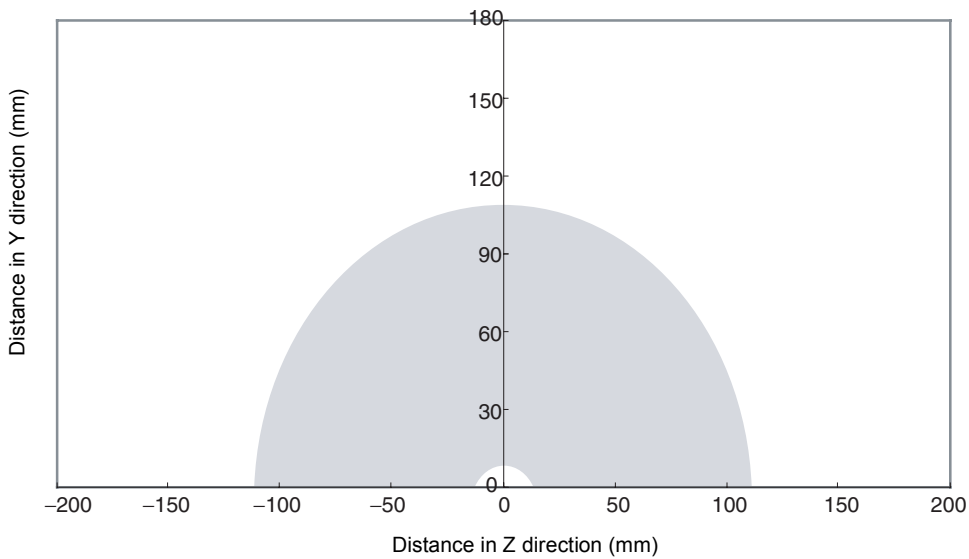

- WRITE

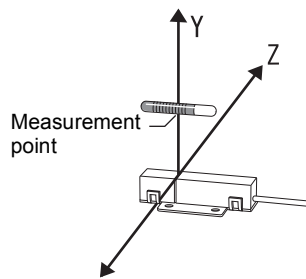
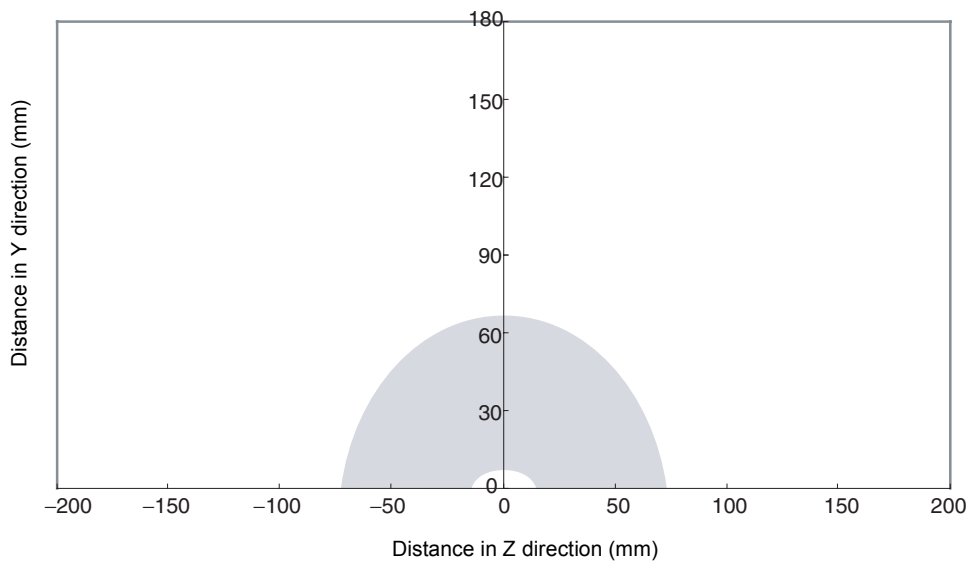

■ Vertical Mounting (RI-TRP-WR2B)

- READ

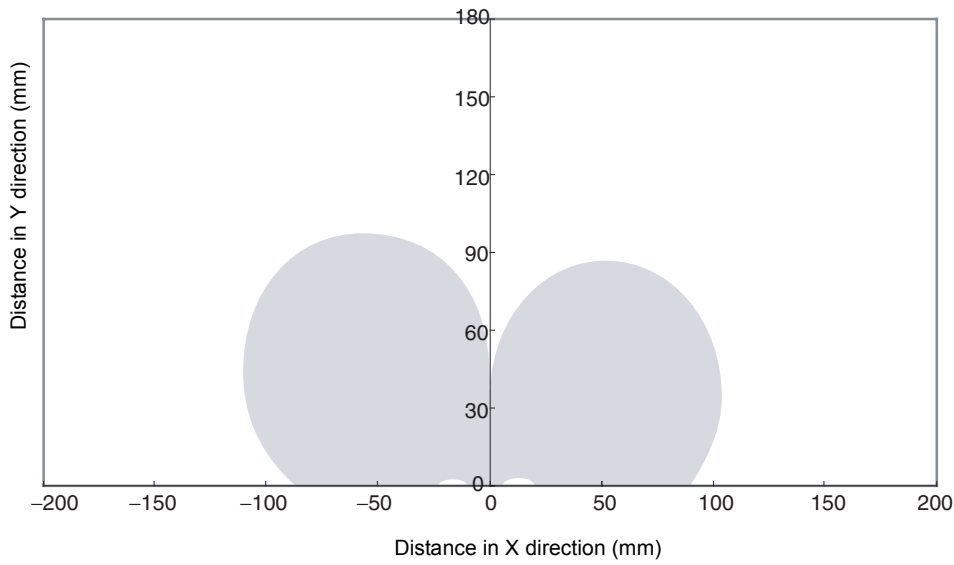

- WRITE

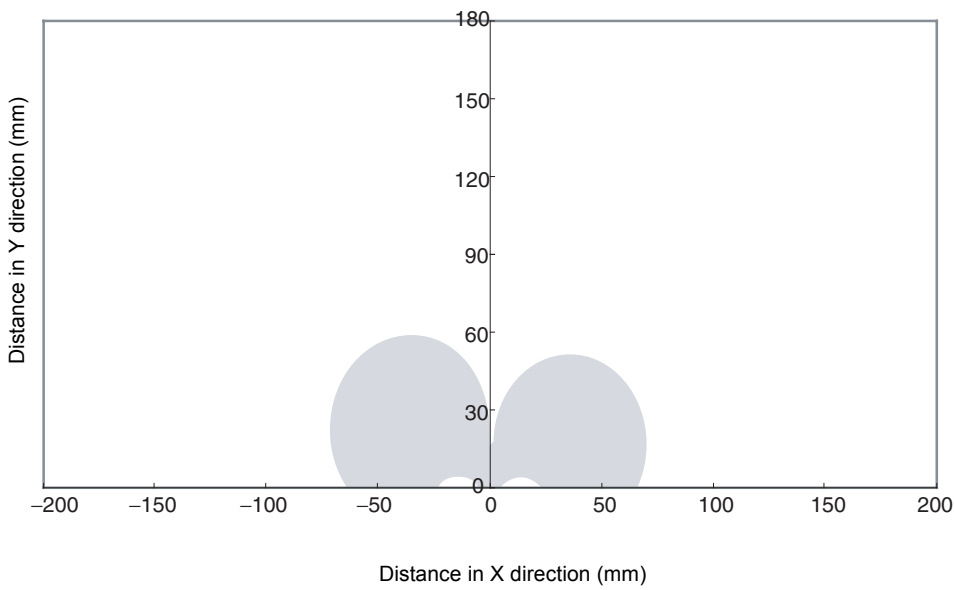

■ Vertical Mounting (RI-TRP-WR2B)

- READ

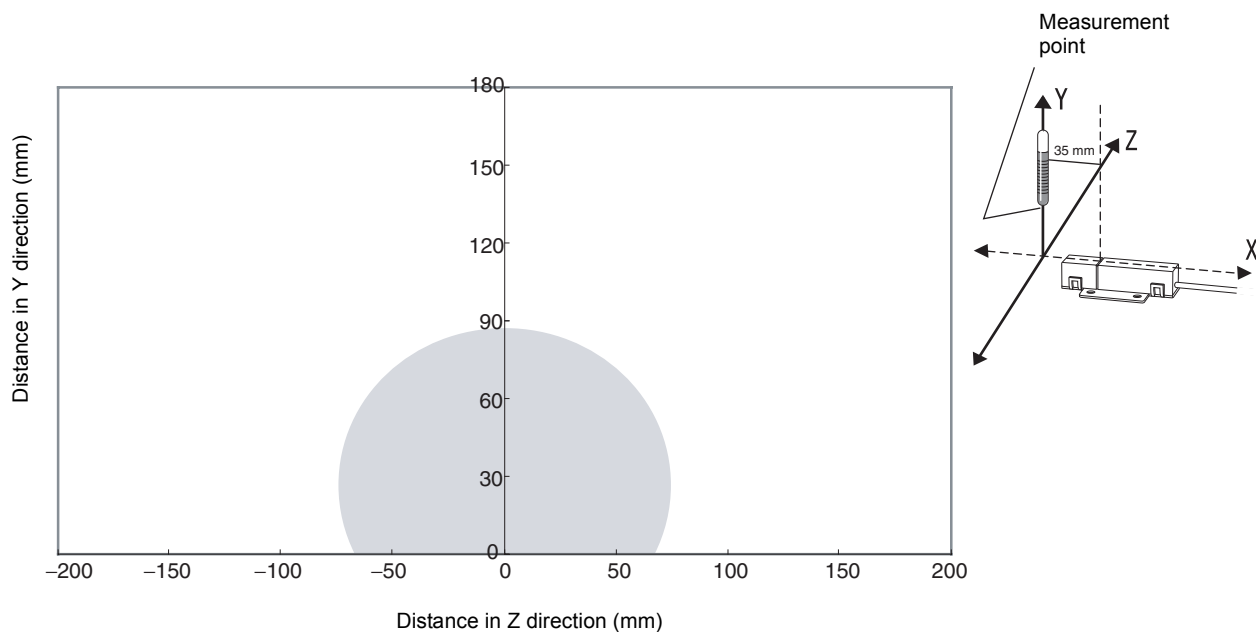

- WRITE

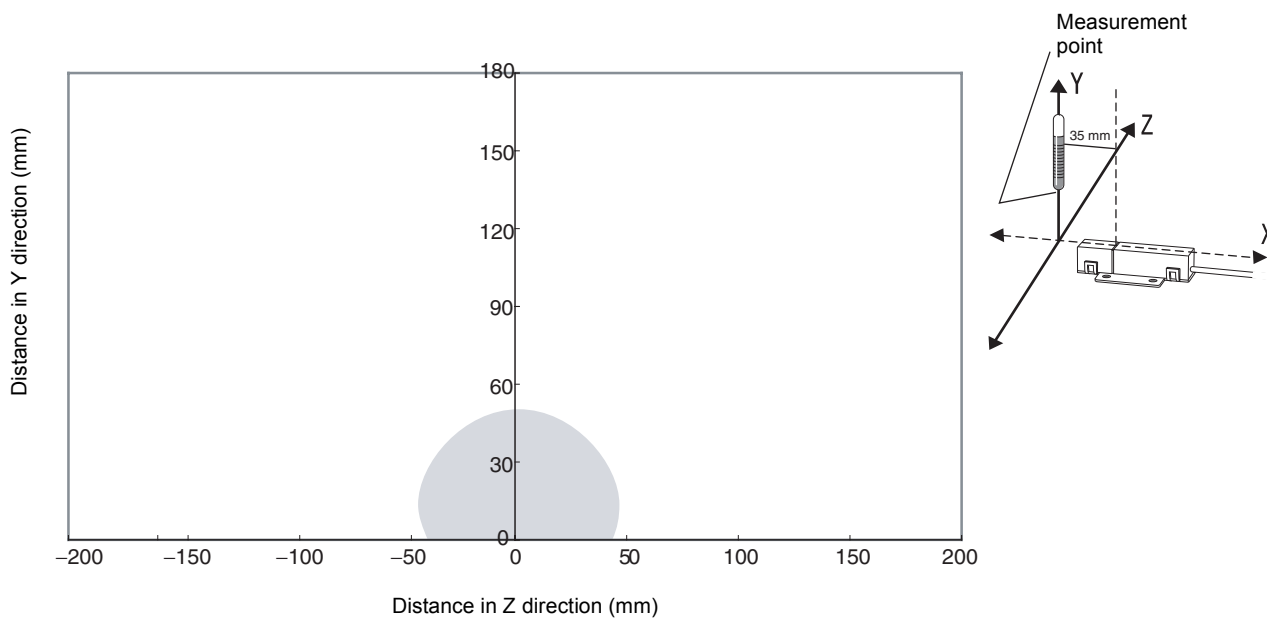

Mutual Interference Distances (Reference Only)

If Amplifier Units are connected using multidrop connections and multiple CIDRW Heads are used, the CIDRW Heads will not process commands simultaneously. In this case, install the CIDRW Heads at least 0.1 m apart from each other.

Distance between Antennas and Changes in Communications Distances (Reference Only)

Distance between Antennas	Change in communications distance
1,000 mm	100%
900 mm	99%
800 mm	97%
700 mm	95%
600 mm	93%
500 mm	88%
400 mm	74%
300 mm	59%
200 mm	37%

If CIDRW Heads in separate CIDRW systems process commands simultaneously when the CIDRW Systems are installed close to each other, mutual interference between the Heads can result in malfunctions. If this is a problem, install the CIDRW Heads separated at least by the distances shown in the following illustrations.

■ For Coaxial Installation

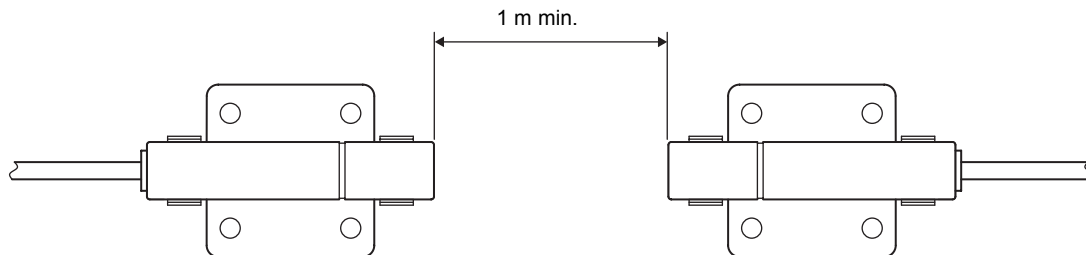

■ For Parallel Installation

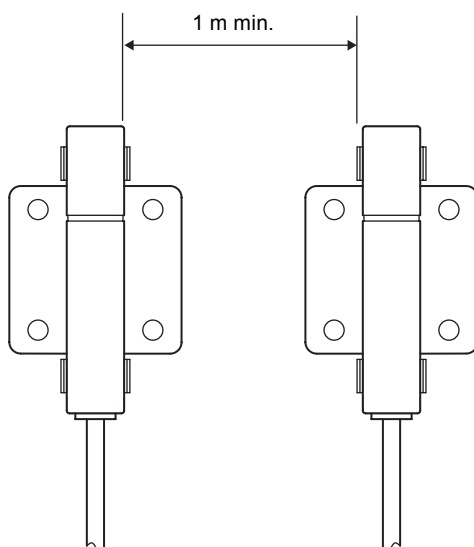

■ For Face-to-Face Installation

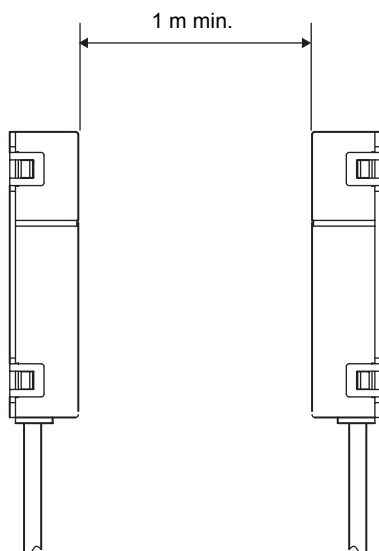

Influence of Background Metals (Reference Only)

The CIDRW Head can also communicate from an opening in a ceiling panel (metal body).

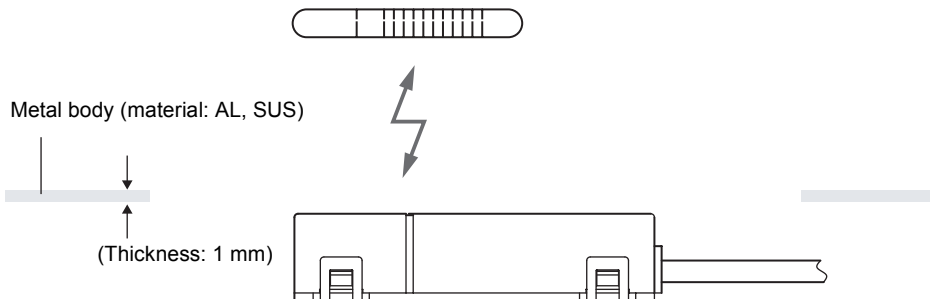

However, ensure the distances indicated below between the CIDRW Head and the metal body. If you do not ensure these distances the communications distance will be substantially shortened.

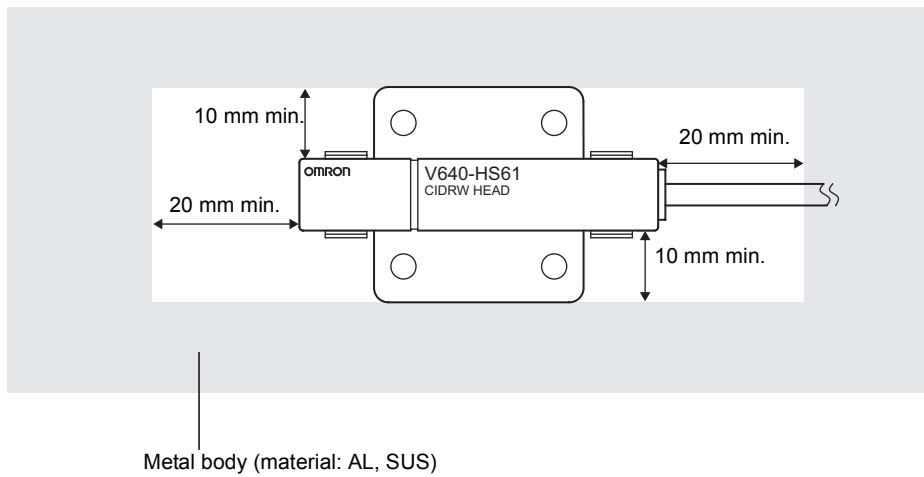

Communications Time

Regardless of whether SECS is used or not, take the time required for processing between the host device and Amplifier Units into account when designing the system.

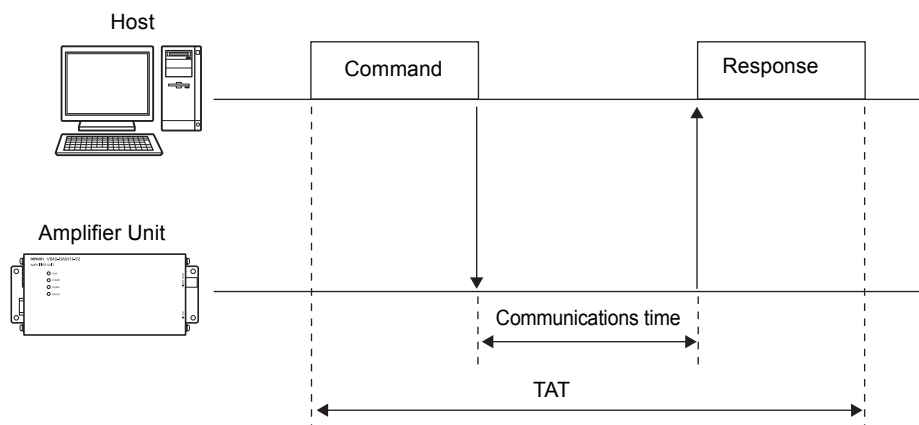

Time	Description
Communications time	This is the time required for communication between an ID Tag and the CIDRW Head.
TAT	This is the time required for processing at the Amplifier Unit, seen from the host device.

Communication time calculation formula (unit: ms)

Read: $150.5 \times (\text{number of pages}) + 6.1$

For write, same writing: $468.6 \times (\text{number of pages}) + 80.3$

Byte write: $468.6 \times (\text{number of pages}/8) + 229.9$

└──────────┘
Rounding up

TAT calculation formula (units: ms)

TAT = command and response transmission time + communication time

The command and response transmission time differs depending on the number of characters sent and the communications conditions.

$$\text{Transmission time (ms)} = \frac{\text{Number of bits per character (bits)}}{\text{Baud rate (bps)}} \times \text{total number of characters of command and response}$$

This calculation applies to continuous transmission in which the Controller uses no spaces between command characters.

Example of TAT calculation:

Number of command characters: A; number of response characters: B

Baud rate: 9600 bps, data length: 8 bits, non parity, 1 stop bit

$$\text{TAT (ms)} = \frac{10}{9600} \times (A + B) + \text{Communications time (ms)}$$

The graph for communications time for communication between the ID Tag and CIDRW Head, and TAT (when the baud rate is 9600 bps), is shown below.

The communications time and TAT, however, may increase substantially according to the conditions of use.

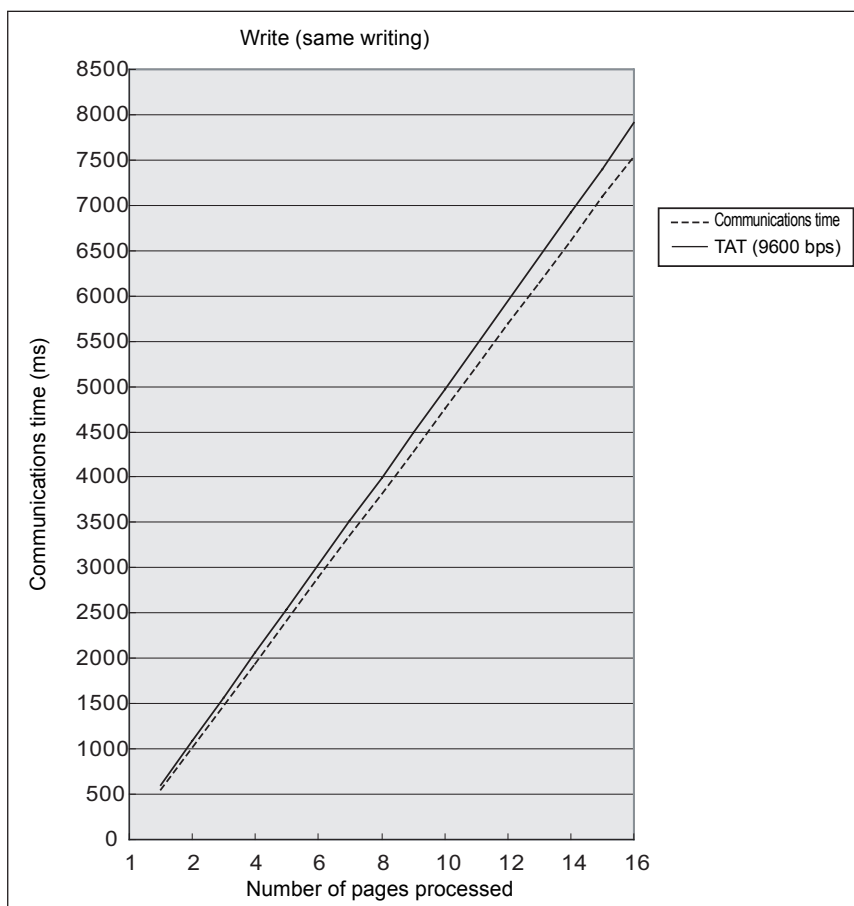
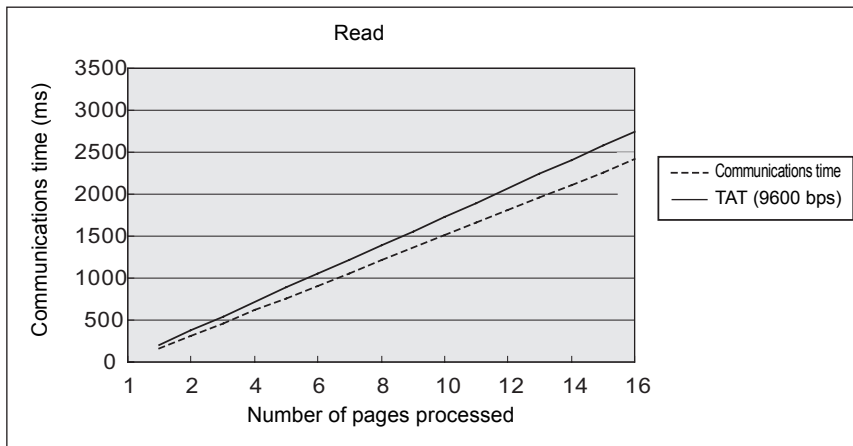

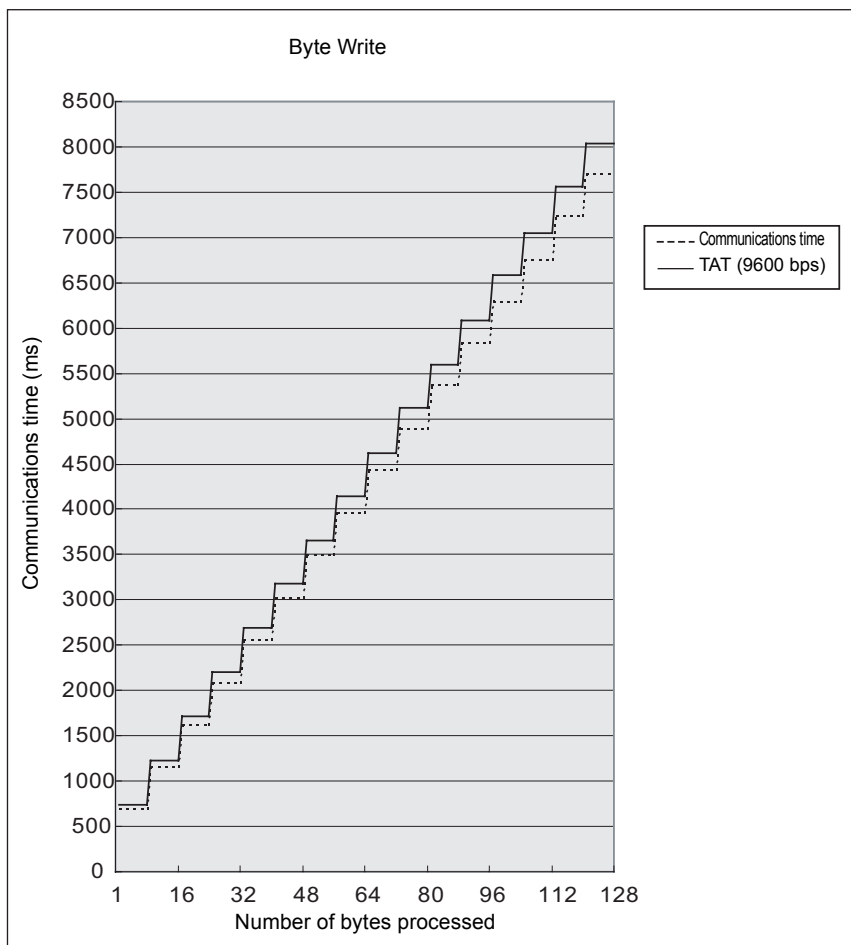

Communications Distance Characteristics vs. Ambient Noise

The graph below compares the results of measurement using the noise measurement function with communications distances.

At installation implement measures in regard to metal in the vicinity of the CIDRW Head, power supply noise, and atmospheric noise, to ensure that the noise level does not exceed 10.

Noise measurement command (applies only when SECS is not used)  Refer to page 89.

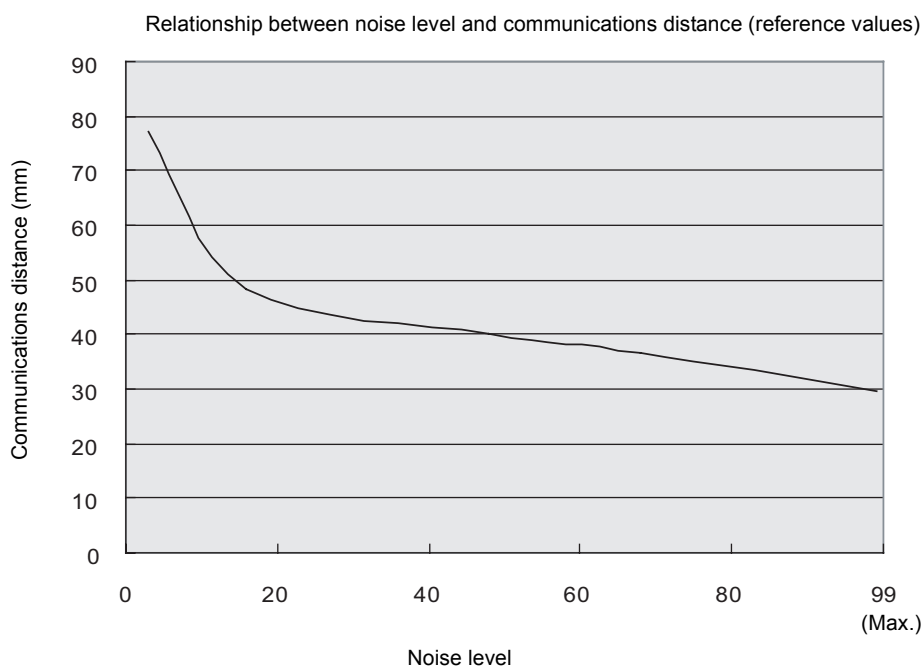

Data Segment Area

The data segment area of the RI-TRP-DR2B ID Tag is shown below.
When using a CIDRW Controller, always set the data segment.



Refer to page 53.

Data segment area

Page	8 bytes/1 page							
1	00h	01h	02h	03h	04h	05h	06h	07h
2	08h	09h	0Ah	0Bh	0Ch	0Dh	0Eh	0Fh
3	10h	11h	12h	13h	14h	15h	16h	17h
4	18h	19h	1Ah	1Bh	1Ch	1Dh	1Eh	1Fh
5	20h	21h				27h
6	28h	29h				2Fh
7	30h	31h				37h
8								
9								:
10	:							:
11	:							
12								
13								
14	68h	69h				6Fh
15	70h	71h				77h
16	78h	79h				7Fh
17	80h	81h				87h

Example of data segment settings

DATASEG	LENGTH
Carrier ID	16
"S01"	8
"S02"	8
"S03"	8
"S04"	8
"S05"	8
"S06"	8
"S07"	8
"S08"	8
"S09"	8
"S10"	8
"S11"	8
"S12"	8
"S13"	8
"S14"	8
"S15"	8

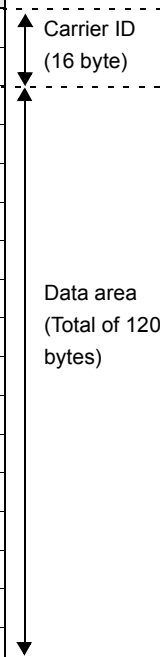

- The carrier ID memory area starts from page 1 (fixed).
- 00h to 87h in the table are addresses.

Regular Inspection

In order to maintain optimum performance of the functions of the CIDRW system, daily and periodic inspections are necessary.

Inspection item		Detail	Criteria	Tools required
Supply voltage fluctuation		Check that the supply voltage fluctuation at the power supply terminal block is within the permissible range.	To be within supply voltage rating.	Multimeter
		Check that there are no frequent instantaneous power failures or radical voltage drops.	To be within permissible voltage fluctuation range.	Power supply analyzer
Environment	Ambient temperature	Check that the ambient temperature and humidity are within specified range.	To be within the specified range.	Maximum and minimum thermometer Hygrometer
	Ambient humidity			
	Vibration and shock	Check that no vibration or shock is transmitted from any machines.		
	Dust	Check that the system is free of dust accumulation.	To be none.	
	Corrosive gas	Check that no metal part of the system is discolored or corroded.		
I/O power supply	Voltage fluctuation	Check on the I/O terminal block that the voltage fluctuation and ripple are within the permissible ranges.	To be within the specified range.	Multimeter Oscilloscope
	Ripple			
Mounting condition		Check that each device is securely mounted.	There must be no loose screws.	—
		Check that each connector is securely connected.	Each connector must be locked or securely tightened with screws.	
		Check that no screw of the terminal block is loosened.	There must be no loose screws.	
		Check that no wire is broken or nearly broken.	There must be no wire that is broken or nearly broken.	
		Check if grounding to 100 Ω or less has been done.	To be grounded to 100 Ω or less.	

SECS Protocol Specifications

A summary of the SEMI standards that relate to CIDRW is provided for reference when using this product. However, since the SEMI standards are subject to revision, you should also refer to the actual standards.

- SEMI E99 THE CARRIER ID READER/WRIER FUNCTIONAL STANDARD
- SEMI E5 EQUIPMENT COMMUNICATION STANDARD 2 MESSAGE CONTENT (SECS II)
- SEMI E4 EQUIPMENT COMMUNICATION STANDARD 1 MESSAGE TRANSFER (SECS I)

Operation Model

Set the CIDRW Controller's mode switch to 0 and start the system. When the system starts, the initial processing is completed first, then the system will operate according to the status defined by E99.

CIDRW status model

Operational status	OPERATING	Operation in progress in the operating mode	
		IDLE	Status in which no processing is in progress at any head
		BUSY	Status when processing is in progress at any of the heads
	MAINTENANCE	Operation in progress in the maintenance mode # Transitions according to state changes from the host device	
Alarm status	No alarm	Status in which there are no alarms currently in effect at the CIDRW Controller or any of the connected heads	
	ALARM	Status in which an alarm has occurred <ul style="list-style-type: none"> • If a head in an abnormal status is detected during head detection in initial processing, or no heads are detected. (The error will not be cleared until the system has been restarted with the heads connected correctly.) • When a head error is detected in communications with an ID Tag. (The error will be automatically reset if it is cleared in subsequent processing.) • A CIDRW Controller internal error has occurred. 	
Initial status (INITIALIZING)	This is the status during processing such as internal initialization/head detection after startup, which is maintained until the CIDRW system is capable of its proper functions.		

CIDRW Head status model

Operational status	OPERATING	Status in which the head is operating normally	
		IDLE	Status in which no processing is in progress
		BUSY	Status in which processing is in progress
	NON-OPERATING	Status in which a head check (IDRW Head, Link Unit) is necessary (The CIDRW alarm status is the ALARM status.)	

Protocol Specifications

- Character composition
Start bit (1) + data bits (8) + stop bit (1)
* Conforms to SEMI E4

- Protocol parameters

Sign	Name	Default setting	Setting range	Setting unit
BAUD	Baud Rate	9600	1200, 2400, 4800, 9600, 19200, 38400, 57600, 115200	-
DEVID	Device ID	0	0 to 32767	1
T1	Time-out between characters	0.5 s	0.1 to 10 s	0.1 s
T2	Protocol time-out	10 s	0.2 to 25 s	0.2 s
T3	Response time-out	45 s	1 to 120 s	1 s
T4	Time-out between blocks	45 s	1 to 120 s	1 s
RTY	Retry limit	3	0 to 31	1
M/S	Master/slave	M	M: Master S: Slave	-

- Double block detection

The header of the block currently being received is compared with the correct block received immediately before, and double blocks are detected. A setting in the setting mode determines whether this function is used or not.

- Multi-block

Multi-blocks are supported at the receiving side (maximum of 128 blocks).
Multi-blocks are used at the sending side.

- Message size

The maximum receivable message size is 32 kbytes.

- Interleaving

The receiving side supports interleaving and block interleaving.

The sending side uses interleaving and block interleaving.

The maximum number of simultaneously open transactions is 16. If the maximum number is exceeded, SxF0 (abort transmission) is sent.

- Device ID

The number of device IDs used is 1. Device IDs are specified in the setting mode.

- Block numbers

With a single block, the block number is either 1 or 0. For multi-block transmission, the numbers 1 to 128 are used. The block number for a single block is set in the setting mode.

- Treatment of the systems byte

The system byte comprises the source ID and the transaction ID.

The source ID is a fixed value and is specified in the setting mode.

The initial value of the transaction ID is 1 and the maximum value is 0xFFFF. The value is incremented from the first message transmission.

- Storing

The method for storing in the BUSY status, e.g. because the internal buffer is full, is to use NAK transmission.

- Processing for time-out detection

At T3 and T4 time-outs, the time-out is notified by the S9F9 message.

- SECS parameters

Item	Default setting	Range	Setting Unit
Double block detection yes/no	1	1: The header of the block currently being received is compared with the correct block received immediately before, and double blocks are detected. 0: Double block detection is not performed.	-
Source ID	0	0 to 32767	1
Single block No.	1	0, 1	-

Support Attributes

CIDRW attribute definitions

	Attribute names	Description	Access	Re-quest	Format and mounting
Basic items	Configuration	Number of CIDRW Heads	RO	Y	20 "00"-"31" The number of heads connected when the system power is turned ON (automatic recognition)
	AlarmStatus	Substate of current CIDRW alarms	RO	Y	20 "0" = no alarm "1" = alarm has occurred
	OperationalStatus	Substate of current CIDRW operations	RO	Y	20 "IDLE" "BUSY" "MANT"
	SoftwareRevisionLevel	Software revision (version)	RO	Y	20 6byte "VVV.RR" (VVV = version, RR = revision)
	CarrierIDOffset	The position of the offset, referenced to the first byte of the carrier ID in the tag.	RW	N	20 00-15 However, (CarrierIDOffset + CarrierIDLength) ≤ 16.
	CarrierIDlength	The number of bytes in the carrier ID (if there are any non-visible ASCII characters in the carrier ID, the CIDRW returns an error to the host controller.	RW	N	20 01-16 However, (CarrierIDOffset + CarrierIDLength) ≤ 16.
Option	DateInstalled	Date on which the sub-system was installed	RW	N	20 8 bytes All " " (space) on shipping
	DeviceType	CIDR / CIDRW classification	RO	N	20 5 bytes "CIDRW"
	HardwareRevisionLevel	Hardware revision number	RO	N	20 6 bytes "VVV.RR" (VVV = version, RR = revision)
	MaintenanceData	Supplier dependent	RW	N	20 80 bytes All " " (space) on shipping
	Manufacturer	Manufacturer's name or ID	RO	N	20 17 bytes "OMRON Corporation"
	ModelNumber	Model name according to the maker	RO	N	20 6 bytes "L22 "
	SerialNumber	System serial number	RO	N	20 max. 20 bytes (Not supported by the CIDRW)

Reader/writer head attribute definition

	Attribute names	Description	Access	Re-quest	Format and mounting
Basic items	HeadStatus	Current status	RO	Y	20 "IDLE" "BUSY" "NOOP"
	HeadID	Head number 1 to 31	RO	Y (multi)	20 "01"- "31" ("00" indicates the CIDRW itself, so cannot be used.)
Option	Cycles	Number of read/write operations executed	RO	N	54 (unsigned 4-byte integer) (Not supported by the Reader/Writer Head)
	HeadCondition	Maintenance status	RO	N	20 "NO": No alarm "NM": Status in which normal operation is not possible and maintenance is necessary "RW": Read/write error "RT": Read/write error rate (Not supported by the Reader/Writer Head) "NP": Status of power supply and connection errors
	HeadDateInstalled	Date on which the head was installed	RO	N	20 "YYYYMMDD" (Not supported by the Reader/Writer Head)
	HeadMaintenanceData	Supplier dependent	N	N	20 (Not supported by the Reader/Writer Head)

ASCII Code Table

Leftmost bits Rightmost bits	b8 - b5	0000	1001	0010	0011	0100	0101	0110	0111	1000	1101	1010	1011	1100	1101	1110	1111	
	b4 - b1	Row Line	0	1	2	3	4	5	6	7	8	9	10	11	12	13	14	15
0000	0	NUL	TC7(DLE)	(SP)	0	@	P	`	p	Undefined	Undefined	Undefined	Undefined	Undefined	Undefined	Undefined	Undefined	Undefined
0001	1	TC1(SOH)	DC ₁	!	1	A	Q	a	q									
0010	2	TC2(STX)	DC ₂	"	2	B	R	b	r									
0011	3	TC3(ETX)	DC ₃	#	3	C	S	c	s									
0100	4	TC4(EOT)	DC ₄	\$	4	D	T	d	t									
0101	5	TC5(NEQ)	TC ₈ (NAK)	%	5	E	U	e	u									
0110	6	TC6(ACK)	TC ₉ (SYN)	&	6	F	V	f	v									
0111	7	BEL	TC ₁₀ (ETB)	'	7	G	W	g	w									
1000	8	FE0(BS)	CAN	(8	H	X	h	x									
1001	9	FE1(HT)	EM)	9	I	Y	i	y									
1010	10	FE2(LF)	SUB	*	:	J	Z	j	z									
1011	11	FE3(VT)	ESC	+	;	K	[k	{									
1100	12	FE4(FF)	IS ₄ (FS)	,	<	L	\	l										
1101	13	FE5(CR)	IS ₃ (GS)	-	=	M]	m	}									
1110	14	S0	IS ₂ (RS)	.	>	N	^	n	À									
1111	15	S1	IS ₁ (US)	/	?	O	_	o	DEL									

Protective Construction

IP-□□ is governed by the test methods described below. Check in advance the seal characteristics under the actual environment and conditions of use.

IP is the abbreviation of International Protection.

■ IEC (International Electrotechnical Commission) Standard (IEC60529: 1989-11)

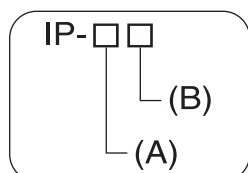









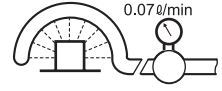

(A) First numeral in code: Class of protection against entry of solid foreign material

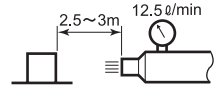
Class	Degree of protection	
0		No protection
1		Protected against access by solid objects with a diameter of 50 mm or greater (e.g. human hands).
2		Protected against access by solid objects with a diameter of 12.5 mm or greater (e.g. fingers).
3		Protected against access by wires and solid bodies with a diameter of 2.5 mm or greater.
4		Protected against access by wires and solid bodies with a diameter of 1 mm or greater.
5		Entry of volumes of dust that would cause difficulties in normal operation of devices or compromise safety is prevented.
6		Entry of dust is prevented.

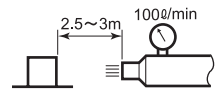
(B) Second numeral of code: Class of protection against the entry of water

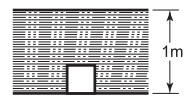
Class	Degree of protection	Outline of test methods (tests using water)	
0	No special protection	No protection against the entry of water.	No test
1	Protection against droplets of water 	The product suffers no ill effects from droplets of water falling vertically onto it.	Water droplets are sprayed onto the product from directly above for 10 minutes by water droplet exposure test apparatus.
2	Protection against droplets of water 	The product suffers no ill effects from droplets of water directed at it at an angle of up to 15° to vertical.	The water droplet exposure test apparatus is set to 15° from vertical and water droplets sprayed onto the product for 10 minutes (total of 25 minutes in each direction).

Class	Degree of protection		Outline of test methods (tests using water)
3	Protection against spraying water 	The product suffers no ill effects from a water spray directed at it at up to 60° from vertical.	Using the test apparatus shown in the figure to the right, water is sprayed from both directions, onto both sides of the product, at angles up to 60° from vertical for 10 minutes.  0.07 L/min. per hole in the spray nozzle
4	Protection against splashing water 	The product suffers no ill effects from water splashed on it from all directions.	Using the test apparatus shown in the figure to the right, water is splashed onto the product from all directions for 10 minutes.  0.07 l/min
5	Protection against water jets 	The product suffers no ill effects from a water jet aimed directly at it from all directions.	Using the test apparatus shown in the figure to the right, a water jet is directed at the product from all directions for 1 minute per square meter of outer casing, with a minimum total exposure of 3 minutes.  12.5 l/min Diameter of spray nozzle head: φ6.3
6	Protection against powerful jets of water 	Water does not enter the product when a powerful jet of water is directed at it from all directions.	Using the test apparatus shown in the figure to the right, a water jet is directed at the product from all directions for 1 minute per square meter of outer casing, with a minimum total exposure of 3 minutes.  100 l/min Diameter of spray nozzle head: φ12.5
7	Protection against immersion in water 	No entry of water on immersion in water at the stipulated pressure for the stipulated time.	Immerse in water for 30 minutes at a depth of 1 meter (when the height of the apparatus is less than 850 mm). 
8	Protection against immersion in water 	The product can be used while continually immersed in water.	Depends on arrangements made between the manufacturer and the user of the product.

Index

A

Amplifier Unit	27, 34
Amplifier Unit Indicators	98
Amplifier Unit V640-HAM11-V2	20
ASCII Code Table	136

B

Byte Write	87
------------	----

C

Change the data segment area	53
Change the response time-out time	56
Changing the Position of the Mode Switch on the Bottom of the Unit	48
Characteristic Data depending on Conditions of Use	109
CIDRW Controller	26, 31
CIDRW Controller V700-L21	19
CIDRW Head	28
CIDRW Head V640-HS61	21
CIDRW Systems that Conform to SEMI Standards (SEMI E99, E5, E4)	17
Coaxial Mounting	110, 111
Command	82
Command/Response Format	81
Communications Distance	
Characteristics vs. Ambient Noise	128
Communications Test	65
Communications Time	125
Component Names and Functions	19
Connections and Wiring	31
Connector for connecting a CIDRW Head	34
Controller Indicators	92

D

Data Reading and Writing	28
Data Segment Area	129

F

Features	17
Flowchart for Getting Started	23
For Coaxial Installation	122
For Face-to-Face Installation	123
For Parallel Installation	123
From Installation to Trial Operation	99
From Trial Operation to Communications	101

H

Host Connection Port	42
----------------------	----

I

ID Tag ↔ CIDRW System Communications Test	66
IEC (International Electrotechnical Commission) Standard (IEC60529: 1989-11)	137
Influence of Background Metal on ID Tag	29
Influence of Background Metals (Reference Only)	124
Influence of Noise	29
Installation	26

L

Link Unit	30, 41
Link unit V700-L11	22
List of Error Messages	92, 98

M

Maps of Communications Areas (Reference Only)	110
Message Specifications	70
Mounting	29
Multi-connection port	45
Mutual Interference Distances (Reference Only)	122

N

NAK	89
Noise measurement	89
Normal Operation Mode	93

O

Operation Check Flowchart	93, 99
Operation Model	131

P

Parallel Mounting	112, 113
Positional Relationship between the CIDRW Head and the ID Tag	28
Power Supply	41
Power Supply and Grounding Wires	31, 34
Protective Construction	137
Protocol Specifications	132

R

READ	83
Regular Inspection	130
RESET	89
Return to the Normal Operation mode	58
RS-232C Port	36
RS-485 Port	39

Index

S

Same Write	86
SECS port	32
SECS Protocol Specifications	131
Sending a Switching Command from the Host Device	49
Set the Communications Conditions for Amplifier Units	61
Set the Communications Conditions for Link Units	63
Set the Communications Conditions for the CIDRW Controller	48
Set the parameters for the communications conditions	50
Setting Mode	96
Specifications and Dimensions	104
Specifications for Each Stream/Function	72
Start the terminal software	49
Support Attributes	134
Switch to the Setting mode	48
System Configuration	18

T

TEST	88
Test for Communications with the Host Device	65

V

Vertical Mounting	114, 115
-------------------	----------

W

What is a CIDRW System?	16
When SECS is Not Used	65, 68, 81, 98
When SECS is Used	18, 65, 66, 70, 92
When the Mode is Selected by a Command Sent from the Host Device	58
When the Mode is Selected with the Mode Switch on the Bottom of the Unit	58
WRITE	84

Revision History

A manual revision code appears as a suffix to the catalog number on the front cover of the manual.

Cat. No. Z167-E1-06A

↑
Revision code

The following table outlines the changes made to the manual during each revision. Page numbers refer to the previous version.

Revision code	Date	Revised content
1	January 2003	Original production
2	May 2003	The V700-L22 replaced the V700-L21 as the CIDRW Controller (to comply with the 2002 edition of SEMI E99).
03	October 2004	<p>Page 18: CHECK information added at bottom of page.</p> <p>Page 22: Function descriptions for No. 1 and 7 corrected.</p> <p>Page 29: Sentence removed from NOTICE at bottom of page.</p> <p>Pages 31, 35, and 41: Addition made to <i>Condition</i> table.</p> <p>Page 37: Diagram changed.</p> <p>Page 38: "Using Link Units" removed from CHECK information.</p> <p>Page 60: Setting corrected in last line of table.</p> <p>Page 66: Target ID corrected in top diagram.</p> <p>Page 104: Weight corrected.</p> <p>Page 108: "RS-232C" added to top diagram and text between diagrams changed.</p> <p>Page 108: "RS-485" added to top diagram and text between diagrams changed.</p> <p>Pages 110 to 115: "Measurement point" added to graphics.</p> <p>Page 116: Additions and changes made at top of page.</p> <p>Page 124: "CIDRW" corrected to "IDRW" in bottom right cell of bottom table.</p> <p>Page 127: Value changed in last column of "Alarm Status" row.</p> <p>Page 130: Time corrected in bottom right cell at bottom of page.</p>
04	December 2004	Page 37: Wiring diagram for connection between V640 and V700-L22 corrected.
05	May 2005	<p>Pages 2 to 4: Changed information on warranty and liability. Also, information on comparison with V700-L21 moved to page 4 from the beginning of the manual.</p> <p>Page 6: Removed information on countries of intended use.</p> <p>Page 17: Added ID Tag model numbers to diagram and added information on ID Tags.</p> <p>Page 110: Added information on ID Tags.</p> <p>Page 115: Added Information and diagrams for the RI-TRP-WR2B.</p>
06	September 2006	<p>Page 6: Added information on Chinese wireless standards and Korean Radio Law.</p> <p>All pages: Removed information on V640-HAM11 Amplifier Unit throughout due to discontinued production.</p>
06A	January 2008	<p>Page 10: Added section on communications with the host device and section on a startup precaution.</p> <p>Pages 50 and 59: Corrected default setting for double block detection to "0."</p> <p>Pages 71 and 82: Added "CHECK" items.</p>