

K3GN

1/32 DIN Digital Panel Meter

USER'S MANUAL

OMRON

PREFACE

This User's Manual provides you with information necessary for use of the K3GN series of digital panel meters.

Please read this manual carefully to ensure correct and efficient use of the product.

Keep this manual handy for future reference.

General Precautions

If contemplating using the product in the following environments or for the following equipment, first contact a sales representative of the company and then accept responsibility for incorporating into the design fail-safe operation, redundancy, and other appropriate measures for ensuring reliability and safety of the equipment and the overall system.

- (1) Environments deviating from those specified in this manual
- (2) Nuclear power control systems, traffic (rail car/automobile/aircraft) control systems, medical equipment, amusement equipment, and rescue and security equipment
- (3) Other equipment that demands high reliability, including those related to the safety of life and property

About the Contents of the Manual

- (1) Any reproduction, full or in part, of the manual is prohibited without prior written permission from the company.
- (2) Specifications in the manual may be subject to change without notice.
- (3) Information in the manual has been carefully checked for accuracy. If finding any suspicious or erroneous descriptions in the manual, however, you are kindly requested to contact a branch office of the company. In such a case, please let us know the Cat. No. shown on the front cover of the manual.

Other Informations

1 Warranty

(1) Warranty Period

The warranty period for an OMRON Product is one year from either the date of purchase or the date on which the OMRON Product is delivered to the specified location.

(2) Extent of Warranty

If an OMRON Product is subject to a failure for which OMRON is responsible during the warranty period, either a replacement product will be provided or the defective product will be repaired free of charge at the place of purchase. This warranty, however, will not cover problems that occur as a result of any of the following.

- a) Using the OMRON Product under conditions or in an environment not described in catalogs or in the specifications, or not operating the OMRON Product according to the instructions contained in catalogs or in the specifications.
- b) Problems caused by something other than the OMRON Product.
- c) Modifications or repairs performed by a party other than OMRON.
- d) Using the OMRON Product for other than its designed purpose.
- e) Problems that could not have been foreseen with the level of science and technology that existed at the time the OMRON Product was shipped.
- f) Problems caused by an Act of God or other circumstances for which OMRON is not responsible.

This warranty covers only the OMRON Product itself. It does not cover any other damages that may occur directly as a result of a problem with the OMRON Product.

2 Limitations of Liability

- (1) OMRON shall not be responsible for special, indirect, or consequential damages originating in an OMRON Product.
- (2) For programmable OMRON Products, OMRON does not accept responsibility for any programming that is performed by a party than OMRON, or for any results arising from that programming.

3 Applicable Conditions

- (1) When using OMRON Products in combination with other products, it is use's responsibility to confirm the suitability of the OMRON Products for the system, devices, and equipment that are being used. OMRON accepts no responsibility for the suitability of OMRON Products used in combination with other products.
- (2) When using OMRON Products in any of the following applications, consult an OMRON representative and check specifications to allow sufficient leeway in ratings and performance, and to implement suitable safety measures, such as safety circuits, to minimize danger in the event of an accident.
 - a) Outdoor applications, applications with potential for chemical contamination or electrical interference, or application under conditions or environments not described in catalogs.
 - b) Nuclear control systems, railroad systems, aviation systems, vehicles, combustion systems, medical equipment, amusement machines, or equipment regulated by government or Industrial standards.
 - c) Other systems, machines, and equipment that may have a serious influence on human life and property.
 - d) Equipment requiring a high level of reliability, such as gas, water, or electrical supply systems, and systems that operate 24 hours a day.
 - e) Other applications requiring a high level of safety, corresponding to points a) to d), above.
- (3) When OMRON Products are used in an application that could pose significant risk to human life or property, the overall system must be designed so that the required safety can be ensured by providing notice of the danger and incorporating redundancy into the design. Make sure that OMRON Products are appropriately wired and mounted to serve their intended purpose in the overall system.
- (4) Application examples provided in catalogs are for reference only. Confirm functionality and safety before actually using the devices and equipment.
- (5) To prevent unexpected problems from arising due to the OMRON Product being used incorrectly by the customer or any other party, make sure that you understand and carefully observe all of the relevant prohibitions and precautions.

4 Changes to Specifications

Specifications and accessories to the products in catalogs may be changed as needed to improve the products or for any other reason. Check with your OMRON representative for the actual specifications for OMRON Products at the time of purchase.

5 Applicability

The above information assumes that business and product application will be conducted in Japan. For business and application outside of Japan, consult with your OMRON representative.

Signal Words and Safety Notices

● Signal Words

In this manual, safety notices are divided into WARNING and CAUTION according to the hazard level.

As both of WARNING and CAUTION notices contain important information for ensuring safety, be sure to observe them.



A signal word indicating a potentially hazardous situation which, if not avoided, may result in minor or moderate injury or property damage.

● Symbols

	Indicates a CAUTION or WARNING with the specific contents indicated in the triangle and described in text. The example at the left is for a general precaution.
	Indicates a prohibition with the specific contents described in text, which is general unless otherwise classified.
	Indicates a prohibition with the specific contents indicated behind the circle and slash and described in text. The example at the left is for prohibiting disassembling.
	Indicates a mandatory action with the specific contents indicated in the circle and described in text. The example at the left is for a general mandatory action that is not classified otherwise.

● **Safety Notices**

 CAUTION	
Do not touch the terminals while power is being supplied. Doing so may possibly result in electric shock	
Do not allow pieces of metal, wire clippings, or fine metallic shavings or filings to enter the product. Doing so may occasionally result in minor or moderate injury or in property damage due to electric shock, fire, or malfunction caused by internal short circulation..	
Do not use the product in locations where flammable or explosive gases are present. Doing so may occasionally result in minor or moderate explosion, causing minor or moderate injury, or property damage.	
Do not use the equipment for measurements within Measurement Categories II III or IV (according to IEC61010-1). Doing so may occasionally cause unexpected operation, resulting in minor or moderate injury, or damage to the equipment. Use the equipment for measurements only within the Measurement Category for which the product is designed.	
Failure to perform correct setting of the product according to the application may occasionally cause unexpected operation, resulting in minor or moderate injury, or damage to the equipment. Ensure safety in the event of product failure by taking safety measures, such as installing a separate monitoring system.	
Ensure safety in the event of product failure by taking safety measures, such as installing a separate monitoring system. Product failure may occasionally prevent operation of comparative outputs, resulting in damage to the connected facilities and equipment.	
Tighten the screws on the terminal block and the connector locking screws securely using a tightening torque within the following ranges. Loose screws may occasionally cause fire, resulting in minor or moderate injury, or damage to the equipment. Terminal block screws : 0.43 to 0.58 N·m. Connector locking screws :	
Do not attempt to disassemble, repair, or modify the product. Doing so may occasionally result in minor or moderate injury due to electric shock.	

Precautions for Safe Use

● Precautions for the environment.

- (1) Do not use the product in the following locations.
 - Locations subject to direct radiant heat from heating equipment
 - Locations here the product may come into contact with water or oil
 - Locations subject to direct sunlight
 - Locations where dust or corrosive gases (in particular, sulfuric or ammonia gas) are present
 - Locations subject to extreme temperature changes
 - Locations where icing or condensation may occur
 - Locations subject to excessive shocks or vibration
- (2) Do not use the product in locations subject to temperatures or humidity levels outside the specified ranges or in locations prone to condensation. If the product is installed in a panel, ensure that the temperature around the product (not the temperature around the panel) does not go outside the specified range. Parts life is dependent on temperatures. A part life shortens when the temperature rises, and it lengthens when the temperature falls. Parts life can be lengthened by lowering the temperature inside the product.
- (3) In order to prevent inductive noise, wire the lines connected to the product separately from power lines carrying high voltages or currents. Do not wire in parallel with or in the same cable as power lines. Other measures for reducing noise include running lines along separate ducts and using shield lines.
- (4) Do not install the product near devices generating strong high-frequency waves or surges. When using a noise filter, check the voltage and current and install it as close to the product as possible. If several products are mounted side-by-side or arranged in a vertical line, the heat dissipation will cause the internal temperature of the product to rise, shortening the service life. If necessary, cool the products using a fan or other cooling method.
- (5) Take care when cleaning the product, because the exterior of the product contains organic solvent (thinner, benzine, etc.), strong alkaline material and strong acid material.
- (6) Avoid storing in high humidity or in a corrosive gas environment (including during transportation)

● Precautions for Safe Use.

- (1) Use and store within the proper temperature and humidity described in the specifications.
- (2) Provide sufficient space around the product for heat dissipation.
- (3) When using the product stored unused over a year after purchasing, the product features may not be utilized sufficiently.
- (4) Avoid storing outdoors and in a place that receives direct sunlight (including during transportation).
- (5) The service life of the output relays depends on the switching capacity and switching conditions. Consider the actual application conditions and use the product within the rated load and electrical service life. Using the product beyond its service life may result in contact welding or burning.
- (6) Be sure to confirm the name and polarity for each terminal before wiring the terminal block and connectors. Faulty wiring causes destruction or burnout of internal parts.
- (7) Use the product within the noted supply voltage and rated load.
- (8) Do not connect anything to unused terminals.
- (9) Output turns OFF when the mode is changed or settings are initialized. Take this into consideration when setting up the control system.

- (10) Install an external switch or circuit breaker and label them clearly so that the operator can quickly turn OFF the power.
- (11) Ensure that the rated voltage is achieved no longer than 2 s after turning the power ON. When applying a voltage gradually, power supply may not be reset or output functions indeterminately.
- (12) Mount to a panel between 1 and 5 mm thick.
- (13) Use the specified size of crimp terminals (M3, width : 5.8 mm max.) for wiring. To connect bare wires, use AWG 28 to AWG 16 to wire the power supply terminals and AWG 22 to AWG 14 for other terminals. (Length of exposed wire : 6 to 8 mm)
- (14) Allow the product to operate without load for at least 15 minutes after the power is turned ON.

Precautions for Correct Use

- (1) Install the product horizontally. Display error has the risk of becoming larger than the standard because heat cannot be radiated.
- (2) When using a noise filter on the power supply, check that the filter is suitable for the supply voltage and current ratings, and then attach the noise filter as close as possible to the K3GN.

<Examples of noise prevention schemes>

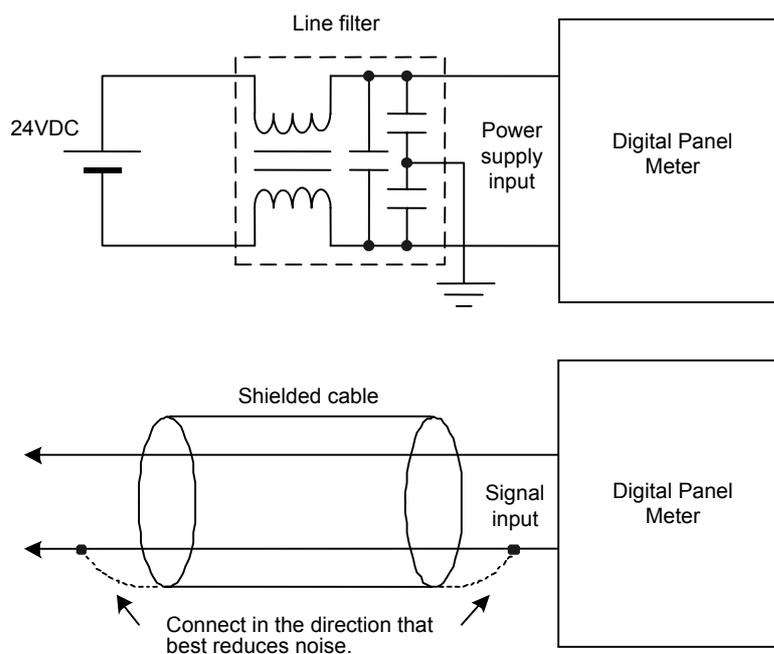

- (3) If placed near the product, radios, TVs, or other wireless devices may suffer reception interference..

Alphabetic Characters for Setting Data

This manual uses the following alphabetic characters for setting data.

A	B	C	D	E	F	G	H	I	J	K	L	M
Ḁ	Ḃ	Ḅ	Ḇ	Ḉ	Ḑ	Ḓ	Ḕ	Ḗ	Ḙ	Ḛ	Ḝ	Ḟ

N	O	P	Q	R	S	T	U	V	W	X	Y	Z
Ḡ	Ḣ	Ḥ	Ḧ	Ḩ	Ḑ	Ḓ	Ḕ	Ḗ	Ḙ	Ḛ	Ḝ	Ḟ

Table of Contents

	PREFACE	I
	General Precautions	I
	Other Informations	II
	Signal Words and Safety Notices	
	Safety Precautions	IV
	Installation and Noise Prevention Tips	V
	Alphabetic Characters for Setting Data	VI
CHAPTER 1	INTRODUCTION	1
	1.1 Main Features	2
	1.2 Model Number Legend	4
	1.3 I/O Circuits	5
	1.4 Parts Name and Function	8
CHAPTER 2	INSTALLATION AND CONNECTION	9
	2.1 Installation	10
	2.2 I/O Terminal Connections	12
CHAPTER 3	APPLICATION EXAMPLES	15
	3.1 Monitoring the Remaining Quantity of Soup	16
	3.2 Monitoring the Load Current of a Motor	18
	3.3 Monitoring the Quantity of Dust	20
	3.4 Monitoring the Internal Pressure of a Tank	22
	3.5 Monitoring the Rotational Speed of a Motor	24
	3.6 Using the Product as a Digital Indicator for PLC	26
CHAPTER 4	INITIAL SETTING	29
	4.1 Using the Product as a process meter	30
	4.2 Using the Product as a Tachometer	32
	4.3 Using the Product as a Digital Indicator for PLC Data	34
CHAPTER 5	OPERATION	37
	5.1 Levels	38
	5.2 Moving among Levels	39
	5.3 Parameters	42
	5.4 Set Values	44
	5.5 Operation Level	45
	5.6 Communication Writing Control	47

5.7	Key Protect Setting	48
5.8	Selecting an Input Type	50
5.9	Selecting an Analog Range	51
5.10	Selecting an Input-pulse Frequency Range	52
5.11	Specifying the Scaling Factor for Analog Input/Digital Data Display	53
5.12	Specifying the Scaling Factor for Input Pulse Frequency	55
5.13	Specifying the Decimal Point Position	58
5.14	Selecting the Output Operating Action	59
5.15	Performing Linear Output	60
5.16	Specifying Communication Parameters	63
5.17	Clearing All Parameters	65
5.18	Specifying the Number of Measurements for Averaging	66
5.19	Specifying the Function of the Event Input	67
5.20	Specifying the Hysteresis	69
5.21	Specifying the Auto-zero Time	71
5.22	Specifying the Startup Compensation Time	73
5.23	Changing the Display Color	75
5.24	Changing the Display Auto-return Time	77
5.25	Changing the Move-to-Protect-Level Time	79
5.26	Changing the Send Waiting Time	81

CHAPTER 6 FUNCTION DESCRIPTION 83

6.1	Measurement	84
6.2	Scaling	86
6.3	Auto-zero/Startup Compensation	88
6.4	Average Processing	89
6.5	Event Input/Pulse Input	90
6.6	Process Value Hold	91
6.7	Forced-zero	92
6.8	Comparative Output	93
6.9	Hysteresis	94
6.10	Display Color Change	95

CHAPTER 7 COMMUNICATIONS 97

7.1	Communication Protocols	98
7.2	Data Format Structure	99
7.3	Structure of Command/Response Text	101
7.4	Variable Area	102
7.5	Read from Variable Area	103
7.6	Write to Variable Area	104
7.7	Operation Instructions	105
7.8	Setting Areas	106
7.9	Commands and Responses	107
7.10	Variable Area Map	115
7.11	Communications Control Flow	118
7.12	Programming Example	123

CHAPTER 8	USER CALIBRATION	127
8.1	User Calibration	128
8.2	User Calibration Processes	130
CHAPTER 9	TROUBLESHOOTING GUIDE	133
9.1	Error Indications	134
9.2	Troubleshooting Table.....	135
	APPENDIX	137
	Specifications	138
	Parameter List.....	142
	ASCII Code Table.....	143

CHAPTER

1

INTRODUCTION

This chapter provides an overview of the product.

1.1	Main Features	2
1.2	Model Number Legend	4
1.3	I/O Circuits	5
	Input Circuit Diagrams/Output Circuit Diagrams/ Internal Block Diagram	
1.4	Parts Name and Function	8

1.1 Main Features

The K3GN is a digital panel meter that is capable of converting an input signal into a digital value and displaying it on the main indicator.

The main features of the product include the following.

Measurement

This feature measures an input signal and displays it as a digital value. An analog value (voltage/current), a rotational speed (pulses), or digital data received via communication function can be selected as an input signal.

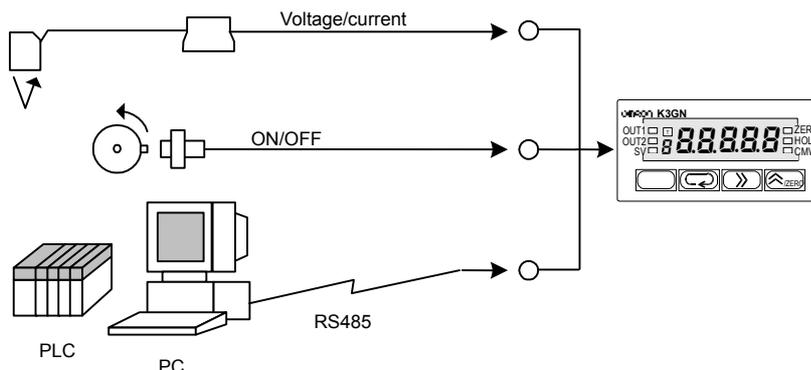

Scaling

This feature converts an input signal into a desired physical value.

The figure on the right shows a scaling example where input signals from a pressure sensor ranging from 4 to 20 mA are converted into values ranging from 0 to 100 (kPa). Scaling will enable you to handle physical quantities easily and intuitively.

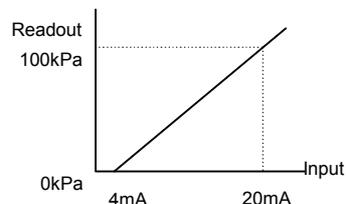

Comparative Output

This feature compares a scaled (process) value with a programmed OUT set value and produces output according to the comparison result.

This is useful in monitoring various systems for malfunction or determining whether products are within acceptance limits.

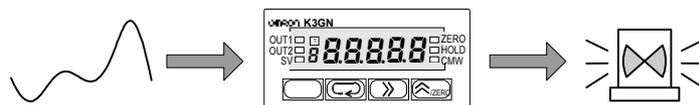

Three types of comparative outputs are available: those produced at the OUT upper-limit value, the OUT lower-limit value, and both the OUT values.

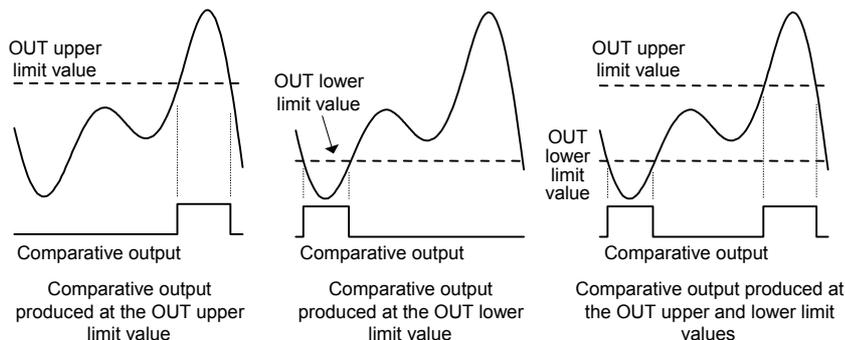

Process Value Hold

This feature enables a process value to be held while the external event input stays ON. The outputs are also retained.

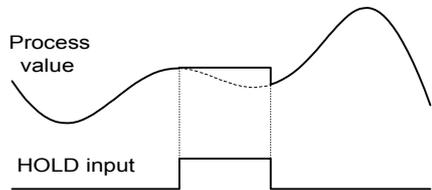

Forced-zero

This feature shifts a process value to zero, and can be used to evaluate and display the deviation of a process value from a reference value. The forced-zero function can be activated by using the  key on the front panel, via the event input terminal, or communications.

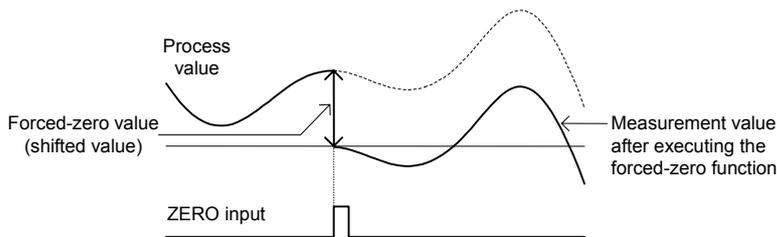

Display Color Change

This feature allows programming of the display color. In the example shown below, the display color is programmed so that it changes from green to red when a comparative output turns ON. The display color can also be programmed so that it changes red to green or is fixed to red or green.

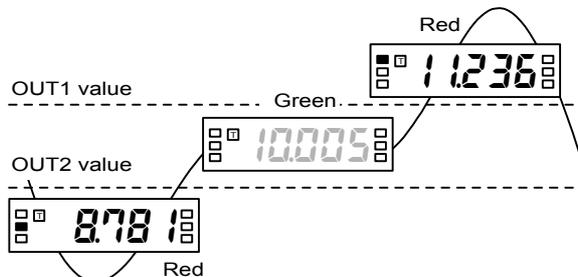

Communi-cation

This feature allows the host PC to read process values from the product or read/write various parameter settings from/to the host PC. The host PC provides logging of measured data and remote control to the product.

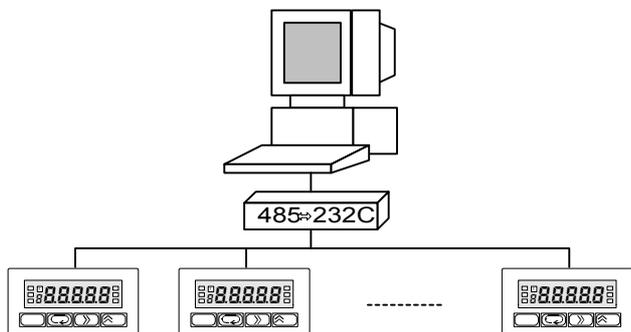

1.2 Model Number Legend

K3GN-□□-□-□ 24 VDC

1 2 3 4

1. Input Type

ND: DC voltage/current, NPN

PD: DC voltage/current, PNP

2. Output Type

C: 2 relay contact outputs (SPST-NO)

C-FLK: 2 relay contact outputs (SPST-NO) and RS-485

C-L1: 2 relay contact outputs (SPST-NO) and DC current (0 to 20 mA, 4 to 20 mA)

C-L2: 2 relay contact outputs (SPST-NO) and DC voltage (0 to 5 V, 1 to 5 V, 0 to 10 V)

T1: 3 transistor outputs (NPN open collector)

T1-FLK: 3 transistor outputs (NPN open collector) and RS-485

T1-L1: 3 transistor outputs (NPN open collector) and DC current (0 to 20 mA, 4 to 20 mA)

T1-L2: 3 transistor outputs (NPN open collector) and DC voltage (0 to 5 V, 1 to 5 V, 0 to 10 V)

T2: 3 transistor outputs (PNP open collector)

T2-FLK: 3 transistor outputs (PNP open collector) and RS-485

3. Option

None: None

-400: Normally energized relays

4. Supply Voltage

24 VDC: 24 VDC

■ List of Models

Supply voltage	Input type	Output type		Model
		Judgement output	Data transmission output	
24 VDC	DC voltage, DC current, or NPN input	2 relay contact outputs (SPST-NO)	None	K3GN-NDC 24 VDC
			RS-485	K3GN-NDC-FLK 24 VDC
			DC current (0 to 20 mA, 4 to 20 mA)	K3GN-NDC-L1 24 VDC
			DC voltage (0 to 5 V, 1 to 5 V, 0 to 10 V)	K3GN-NDC-L2 24 VDC
		2 relay contact outputs (SPST-NO) Normally energized relays (See note.)	None	K3GN-NDC-400 24 VDC
			RS-485	K3GN-NDC-FLK-400 24 VDC
			DC current (0 to 20 mA, 4 to 20 mA)	K3GN-NDC-L1-400 24 VDC
			DC voltage (0 to 5 V, 1 to 5 V, 0 to 10 V)	K3GN-NDC-L2-400 24 VDC
	3 transistor outputs (NPN open collector)	None	K3GN-NDT1 24 VDC	
		RS-485	K3GN-NDT1-FLK 24 VDC	
		DC current (0 to 20 mA, 4 to 20 mA)	K3GN-NDT1-L1 24 VDC	
		DC voltage (0 to 5 V, 1 to 5 V, 0 to 10 V)	K3GN-NDT1-L2 24 VDC	
	DC voltage, DC current, or PNP input	2 relay contact outputs (SPST-NO)	None	K3GN-PDC 24 VDC
			RS-485	K3GN-PDC-FLK 24 VDC
		3 transistor outputs (PNP open collector)	None	K3GN-PDT2 24 VDC
			RS-485	K3GN-PDT2-FLK 24 VDC

Note: Refer to page 6 for information on models with normally energized relays.

1.3 I/O Circuits

Input Circuit Diagrams

Analog Input

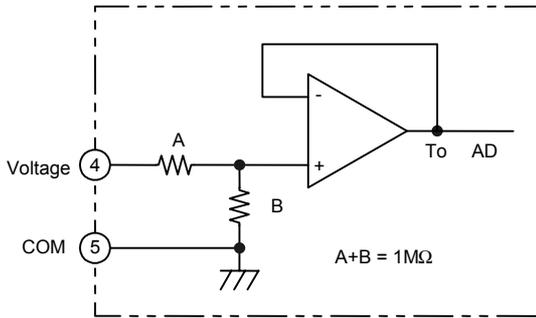

Voltage input

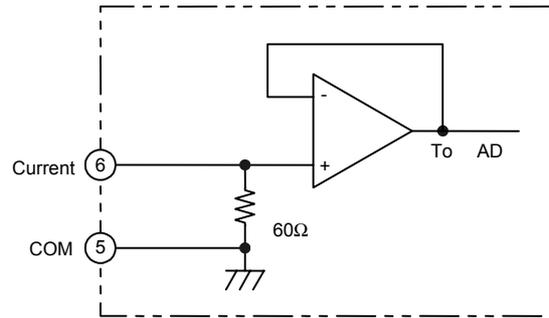

Current input

Event Input/Pulse Input

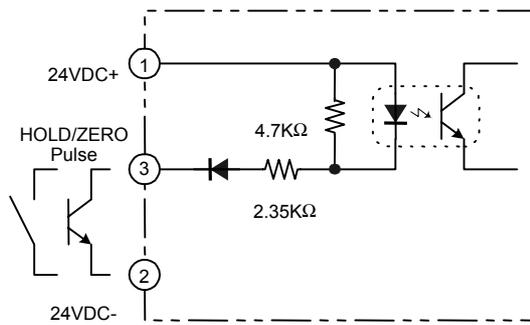

NPN input

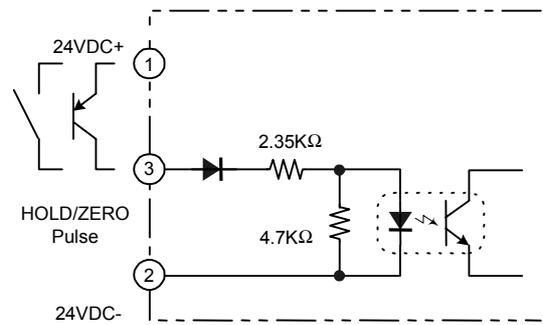

PNP input

Output Circuit Diagrams

Contact Output

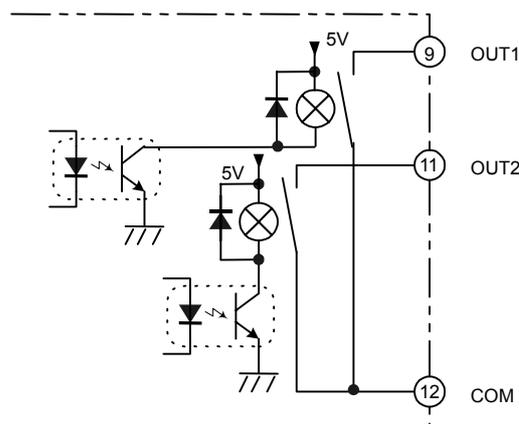

● **Transistor Output**

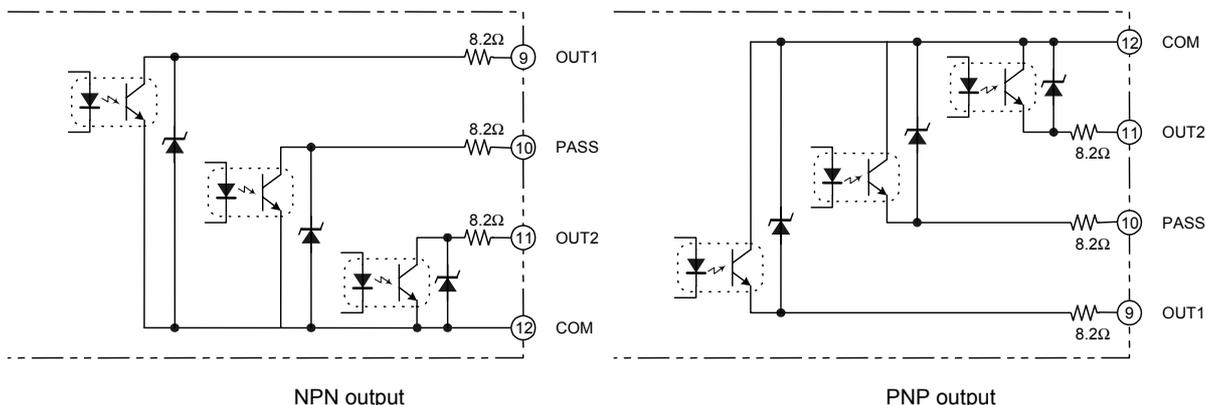

● **Linear Output**

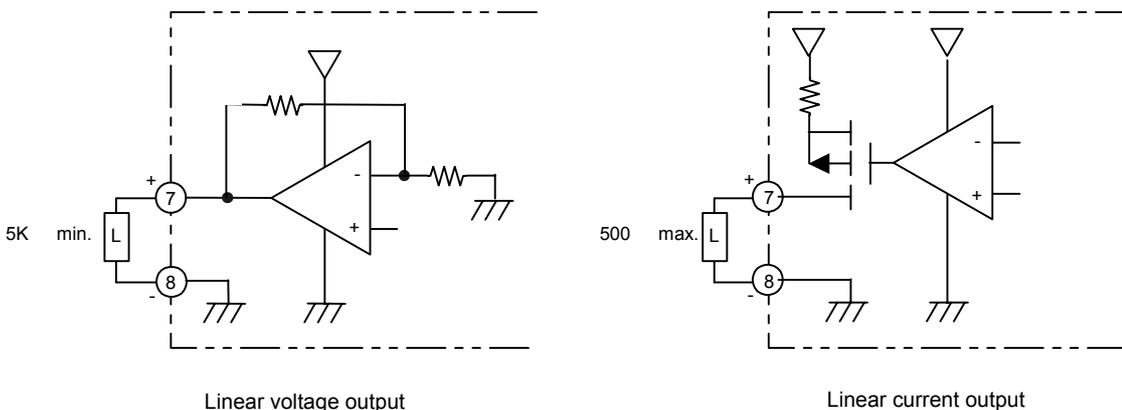

● **Models with Normally Energized Relays K3GN-NDC-□-400 24 VDC**

- The drive operation for the output relay is reversed in these models.
- Relay contacts can be made open (i.e., OFF) when comparative set values are being judged. This is effective when constructing systems that take failsafe measures into consideration.

List of Models

Models with Normally Energized Relays
K3GN-NDC-400 24 VDC
K3GN-NDC-FLK-400 24 VDC
K3GN-NDC-L1-400 24 VDC
K3GN-NDC-L2-400 24 VDC

Relation between Output Type and Relay Output Operation

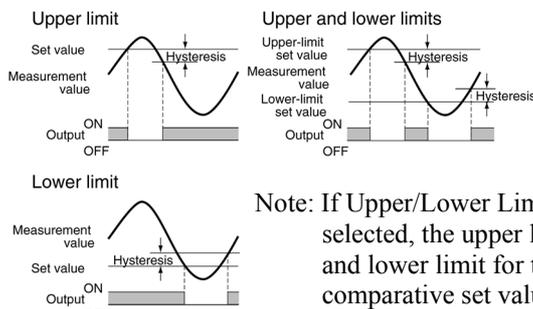

Note: If Upper/Lower Limit is selected, the upper limit and lower limit for the comparative set value can be set individually and will be displayed for OUT1 and OUT2.

■ Internal Block Diagram

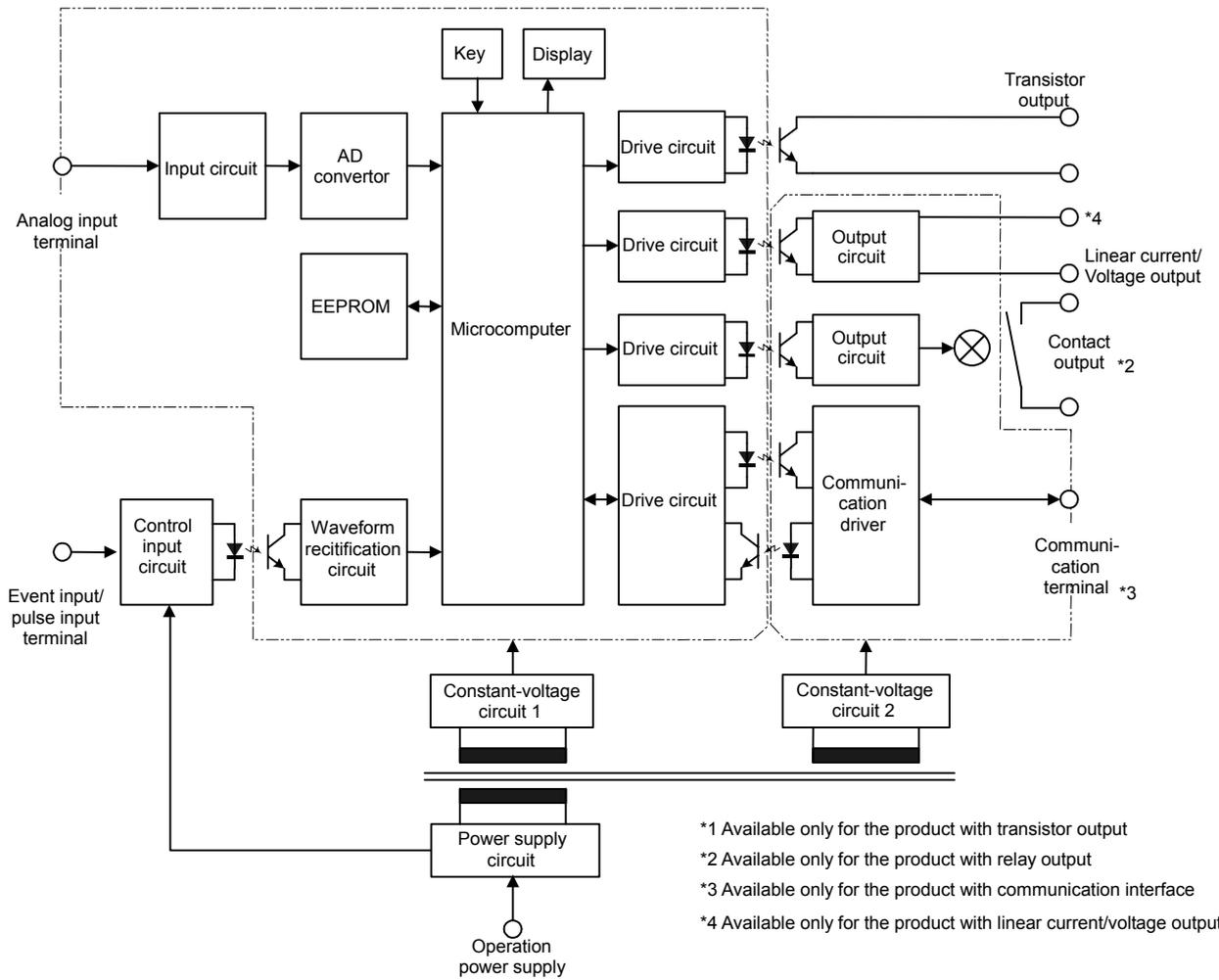

1.4 Parts Name and Function

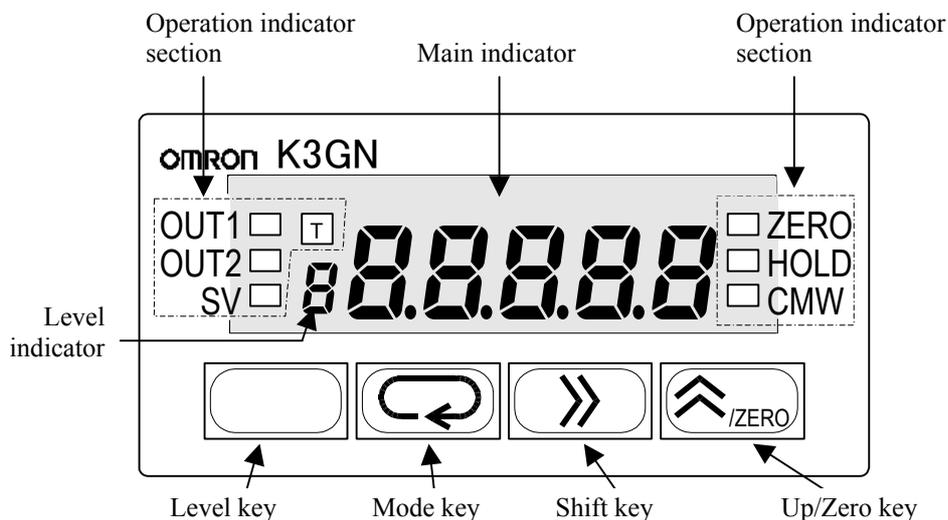

Name		Function
Main indicator		Displays a process value, parameter code, or set value.
Operation indicator sections	OUT1 (Comparative output 1)	Is on when comparative output 1 is ON, and off when comparative output 1 is OFF.
	OUT2 (Comparative output 2)	Is on when comparative output 2 is ON, and off when comparative output 2 is OFF.
	SV (Set value)	Stays on while a set value is displayed or being changed, and off at all other times.
	T (Teaching)	Stays on while a set value that can be taught is displayed, and blinks during teaching. At the calibration level, stays on while a calibration value is displayed, and blinks while the calibration value is read. Stays off at all other times.
	ZERO (Forced-zero)	Is on when zero-shifting by forced-zero operation is active. Turns off when forced-zero operation is canceled.
	HOLD (Process value hold)	Stays on while the process value is held, and off at all other times.
	CMW (Communication writing)	Is on while data reading and writing via communication interface are both enabled. Is off while data writing via communication interface is disabled. Data reading is enabled even if this indicator is off provided that the product has the communication function. If the product has no communication function, this indicator is always off.
Level indicator		Indicates the current level.
Level key		Use to change one level to another.
Mode key		Use to select a parameter.
Shift key		Use to check the set value of a parameter or enter the change state when the parameter is displayed. Use to select the digit that can be changed while shifting the set value.
Up/Zero key		Use to change the set value in the change state. Use to execute or cancel the forced-zero operation when a process value is displayed.

CHAPTER

2

INSTALLATION AND CONNECTION

This chapter describes how to install and connect the product before turning the power on.

2.1	Installation	10
	Dimensions/Panel Cutout Dimensions/ Installation Procedure	
2.2	I/O Terminal Connections	12
	Terminal Arrangement/Terminal Connection	

2.1 Installation

■ Dimensions

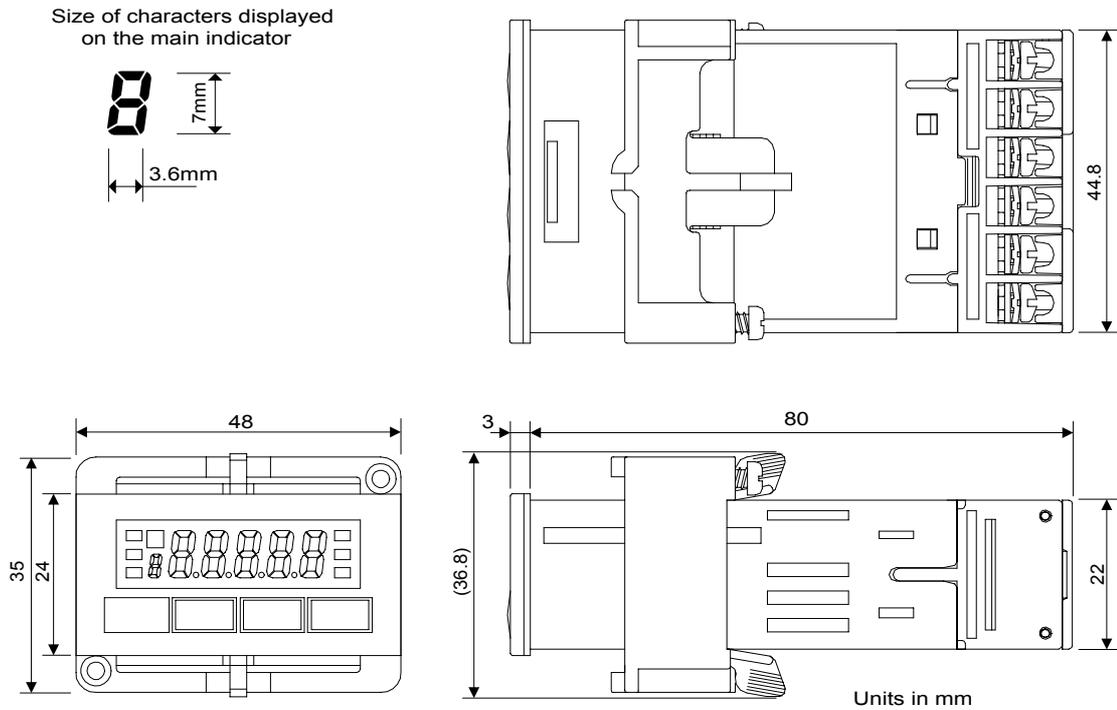

■ Panel Cutout Dimensions

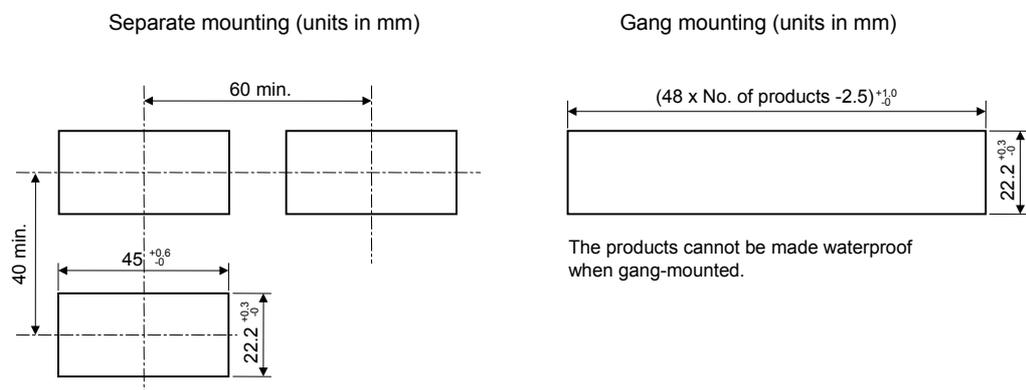

Fit the product into a rectangular panel cutout, put the adapter on the product from the rear end all the way to the panel, and tighten the screws of the adapter to secure the product.

When gang-mounting the products, make sure the ambient temperature of the product falls within the specified limits.

Mount to a panel that is 1 to 5 mm thick. Mounting the product to a thinner panel will reduce the resistance to shock and vibration and may result in a malfunction of the product.

■ Installation Procedure

- (1) Fit the product into a rectangular panel cutout.
- (2) If you want to make the product waterproof, use the watertight packing as shown in the figure below.

Note that the watertight packing is direction-sensitive.

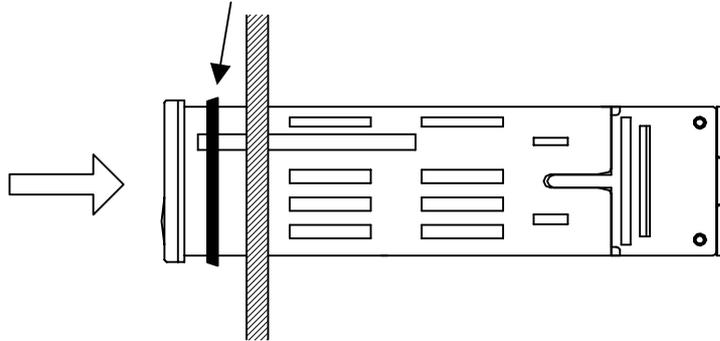

- (3) Put the adapter on the product from the rear end all the way to the panel.

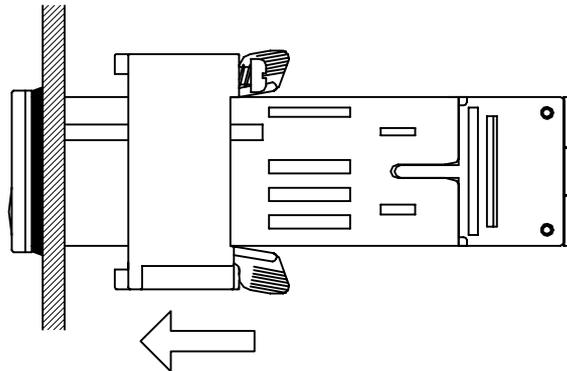

- (4) Tighten the two screws of the adapter in alternate order to a tightening torque of 0.29 to 0.39 N·m.

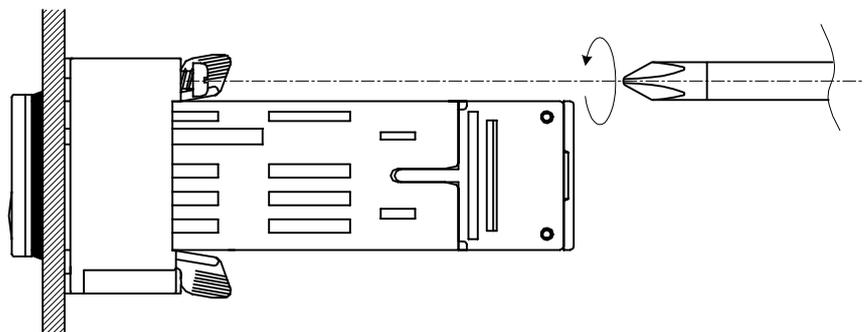

2.2 I/O Terminal Connections

Terminal Arrangement

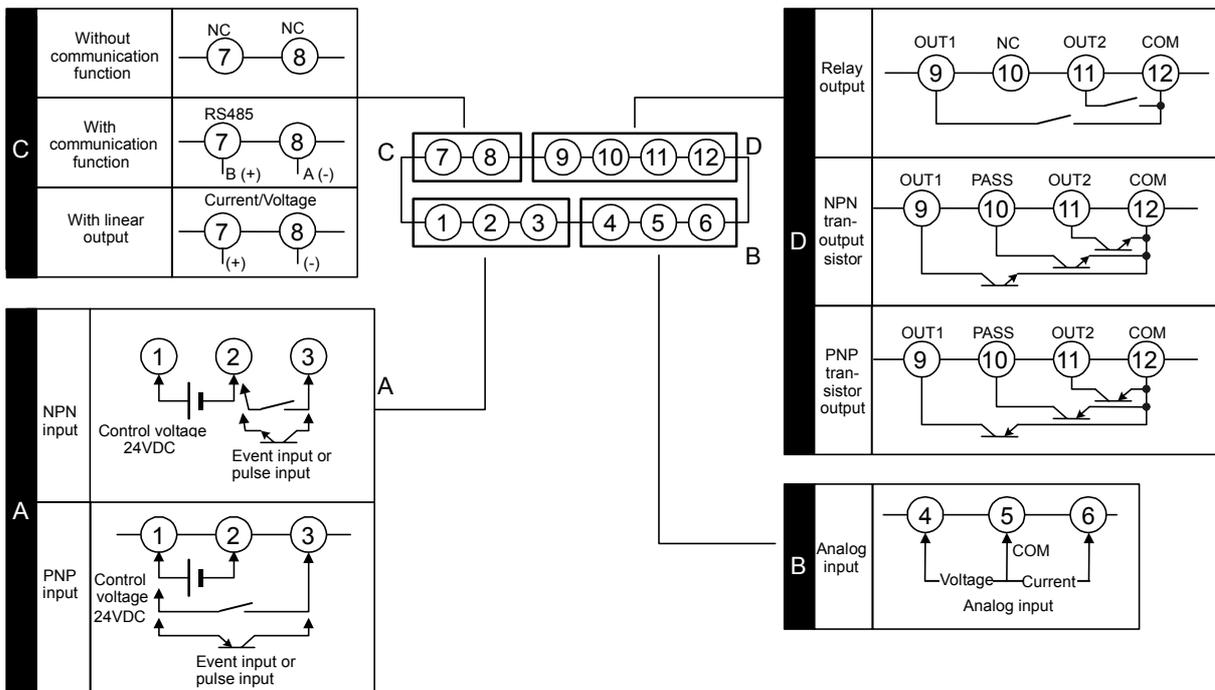

Terminal No.	Name	Description	Applicable model
①-②	Operation power supply	Operation power supply terminals	All models
③-②	Event input or pulse contact/ input	Depending on parameter setting: • Hold the process value. • Serve as input terminals for the forced-zero or forced-zero cancel operation. • Serve as pulse input terminals when the input type is set to "pulse".	K3GN-ND _ _ 24VDC
③-①			K3GN-PD _ _ 24VDC
④⑥-⑤	Analog input	Voltage/current analog terminals	All models
⑦-⑧	Communication	RS-485 communication terminals	K3GN- D -FLK 24VDC
	Linear current output	Linear current output	K3GN- -L1 24VDC
	Linear voltage output	Linear voltage output	K3GN- -L2 24VDC
⑨⑩-⑫	Comparative output	Provide comparative output.	K3GN- DC- 24VDC
⑨⑩⑪-⑫		Provide PASS output in addition to OUT1/OUT2 (comparative output 1/2) when the product is of transistor output type.	K3GN-NDT1- _ 24VDC K3GN-PDT2- _ 24VDC

Terminal Connection

Wire the terminals using M3 crimp contacts of the type shown below.

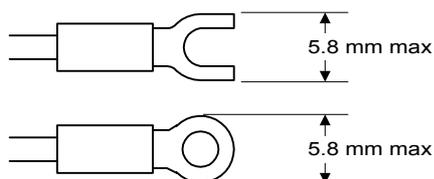

● **Power Supply**



Connect the following power supply to terminals ① and ②.
 Supply voltage: 24VDC
 Operating voltage range: 85 to 110% of the rated voltage
 Power consumption: 2.5W (at max. load)

Note that, when turned on, the product will require the operation power supply to have more power supply capacity than rated.
 If multiple products are used, the power supply must be able to afford to supply power to the products.

● **Event Input or Pulse Input**

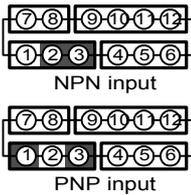

Apply the event or pulse signal to terminals ③ and ② if the product is of NPN input type, or terminals ③ and ① if the product is of PNP input type.

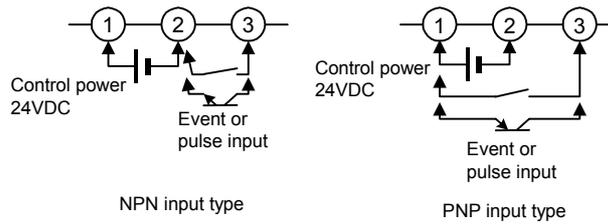

The input equipment connected to these terminals must meet the following conditions.

Transistor output	ON residual current:	2.5V max.
	OFF leakage current:	0.1 mA max.
	Current leakage with transistor turned ON:	15 mA min.
Relay output	Load current:	5 mA max.

● **Analog Input**

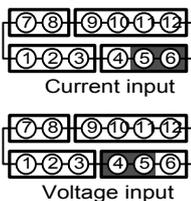

The following table shows the analog ranges and applicable analog input terminals.

Analog range	Positive side	Negative side
4 to 20 mA/0 to 20 mA	⑥	⑤
1 to 5V/0 to 5V	④	⑤
±5V	④	⑤
±10V	④	⑤

The maximum absolute ratings for analog input are as follows.
 Be careful that these ratings must not be exceeded even for a moment.

4 to 20 mA/0 to 20 mA:	±30 mA
1 to 5V/0 to 5V:	±13.5V
±5V:	±13.5V
±10V:	±26V

● **Communication**

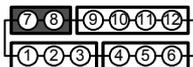

Connect the communication cable to terminals ⑦ and ⑧ if using the communication function.

RS-485 connections can be one-to-one or one-to N. A maximum of 32 units (including the host computer) can be connected in one-to-N systems.

The total length of the communication cables should be up to 500 m.

Use shielded twisted-pair cables (AWG 28 or thicker) as the communication cables.

Be sure to turn ON the terminator switches only in the devices at each end of the transmission line.

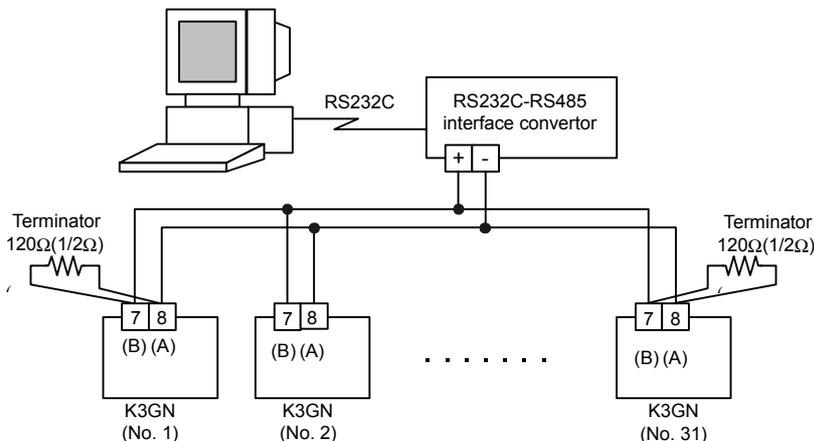

Match the communications format of the K3GN and the host computer. If a one-to-N system is being used, be sure that the communications formats of all devices in the system (except individual unit numbers) are the same.

Chapter 7 explains how to set the K3GN communication format. Refer to your computer's manual for details on changing its communications settings.

● **Comparative Output**

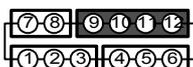

Transistor output

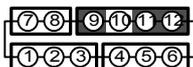

Relay output

Comparative output is produced at terminals ⑨ to ⑫.

If the product is of relay output type, terminal ⑩ is not used.

Loads connected to the product and the power supply for the loads must be rated as follows.

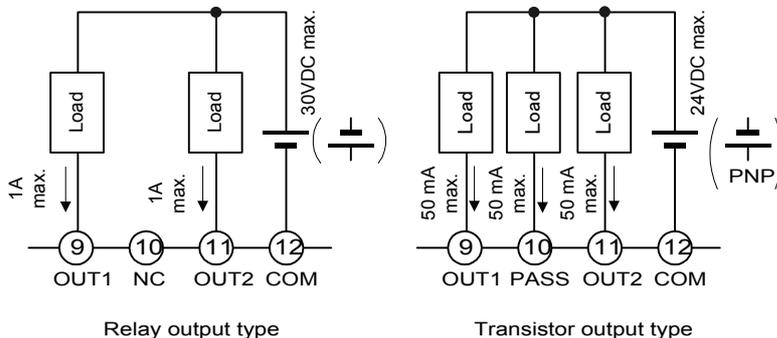

The (PNP) connection causes the current to flow in the direction opposite to indicated by the arrows.

● **Linear Output**

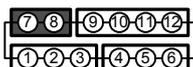

Linear currents and voltages are output between terminals 7 to 8. Contact a load within the specified range.

CHAPTER

3

APPLICATION EXAMPLES

This chapter shows some examples of product applications.

3.1	Monitoring the Remaining Quantity of Soup	16
3.2	Monitoring the Load Current of a Motor	18
3.3	Monitoring the Quantity of Dust	20
3.4	Monitoring the Internal Pressure of a Tank	22
3.5	Monitoring the Rotational Speed of a Motor	24
3.6	Using the Product as a Digital Indicator for PLC	26

3.1 Monitoring the Remaining Quantity of Soup

Application

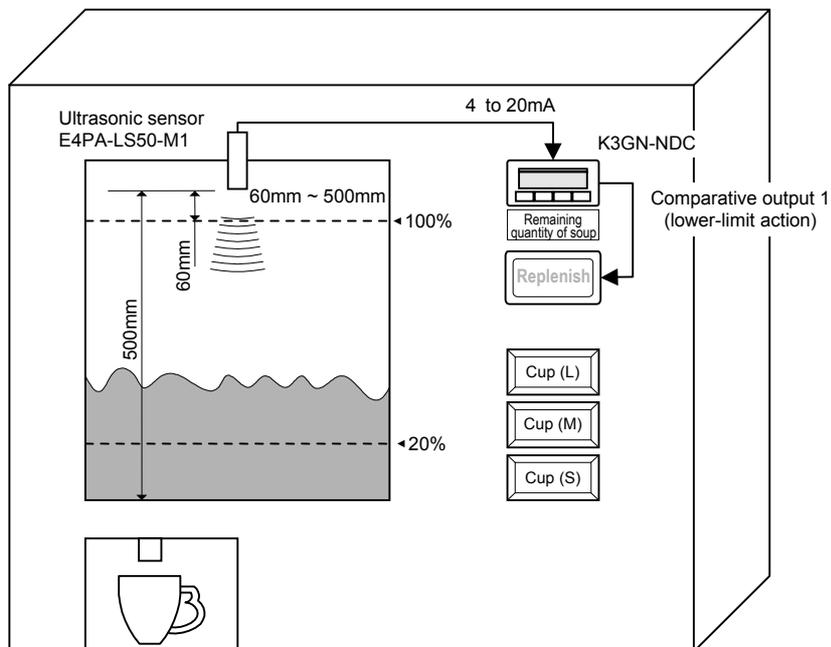

- The remaining quantity of soup is monitored.
- The soup level is measured with an ultrasonic displacement sensor.
- The K3GN indicates the remaining quantity of soup on a percentage basis.
- Four measurements are averaged for stable indication.
- Comparative output 1 is produced as a lower-limit action signal. When the remaining quantity of soup reaches 20% (lower limit), the “Replenish” indicator turns on.

Wiring

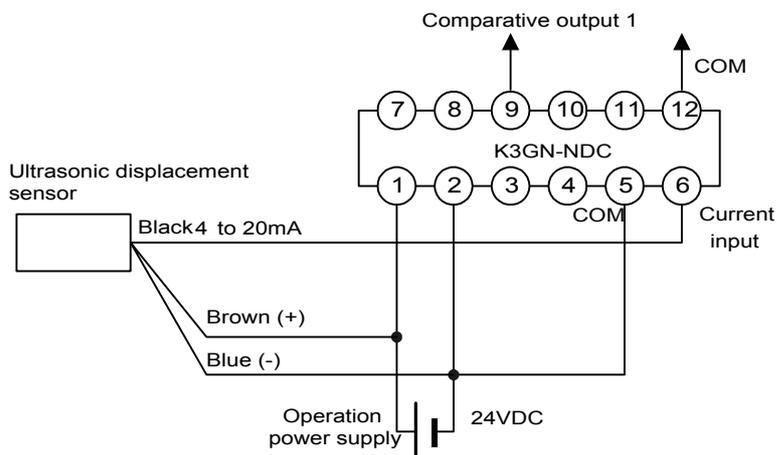

Parameter Setting

Set the parameters of the K3GN as follows.

Level	Parameter	Set value
Initial setting	Unit	Range
	range	4-20
	LnP.1	4.00
	dSP.1	100
	LnP.2	20.00
	dSP.2	0
	dP	00000
	OUT 1k	L0
Advanced-function setting	AWG	4
Operation setting	OUT 1	20

Set the analog output characteristic mode of the sensor to “decrease”. For details on sensor setting, refer to the Operation Manual for the sensor.

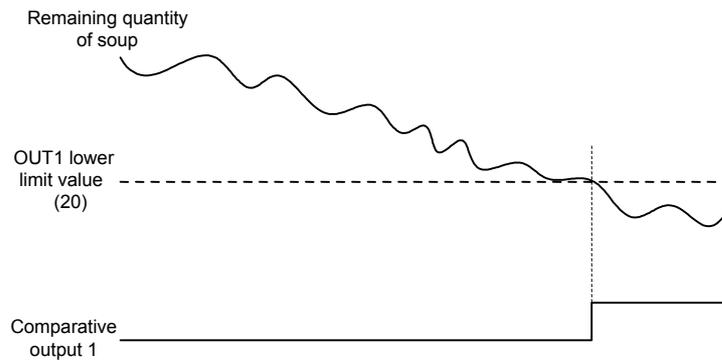
Operation

- Comparative output 1 turns on when the remaining quantity of soup decreases to 20%.

3.2 Monitoring the Load Current of a Motor

Application

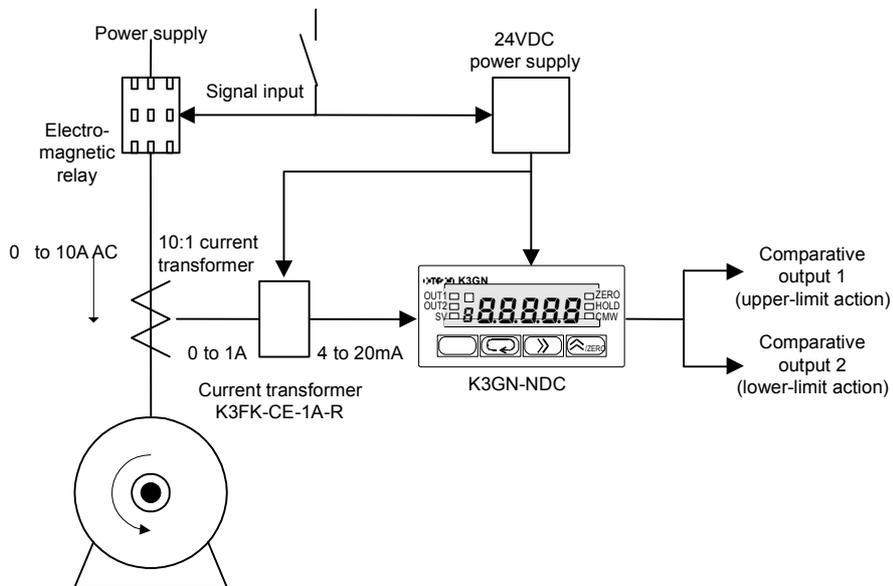

- The load current of a motor is monitored.
- A 10:1 current transformer is used to detect the motor current.
- The current transformer K3FK-CE-1A-R is used to adapt the input current to a K3GN analog range.
- The K3GN indicates the load current in units of amperage to two decimal places.
- Comparative output 1 is used to generate an upper-limit action signal and comparative output 2 is used to generate a lower-limit action signal.
- The OUT upper-limit value is set to 6.00A and the OUT lower-limit value is set to 3.00A.

Wiring

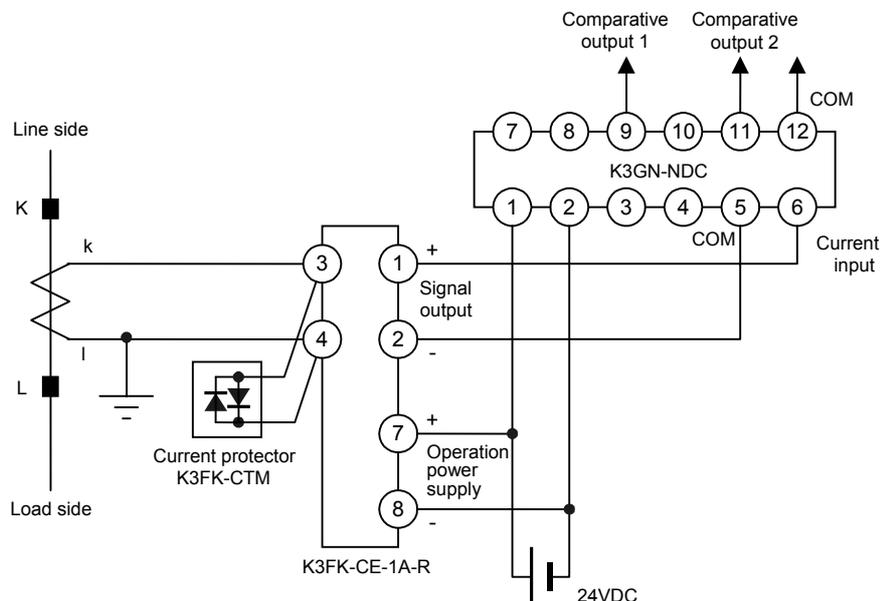

Parameter Setting

Set the parameters of the K3GN as follows.

Level	Parameter	Set value
Initial setting	Unit	ANALG
	range	4-20
	LnP.1	4.00
	dSP.1	0
	LnP.2	20.00
	dSP.2	1000
	dP	000.00
	out 1t	HZ
	out 2t	L0
Operation setting	out 1	6.00
	out 2	3.00

For details on the parameters, refer to **CHAPTER 5 OPERATION**.

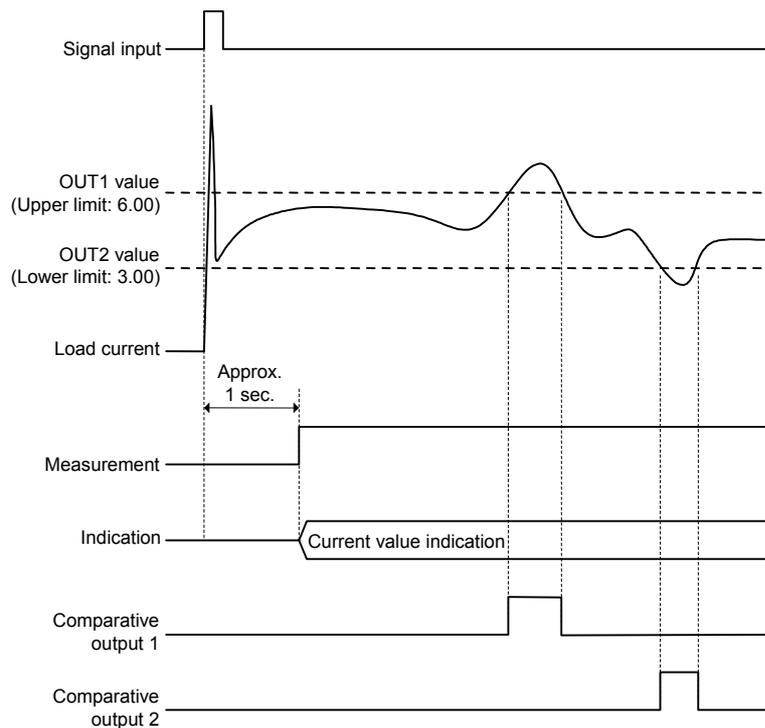
Operation

- Turning the power on causes inrush current to flow through the motor. But the K3GN does not produce superfluous output in response to the inrush current because it does not perform measuring operation for approx. one second after turn-on.
- Comparative output 1 turns on when the current flowing through the motor reaches 6.00A.
Comparative output 2 turns on when the current flowing through the motor decreases to 3.00A.

3.3 Monitoring the Quantity of Dust

Application

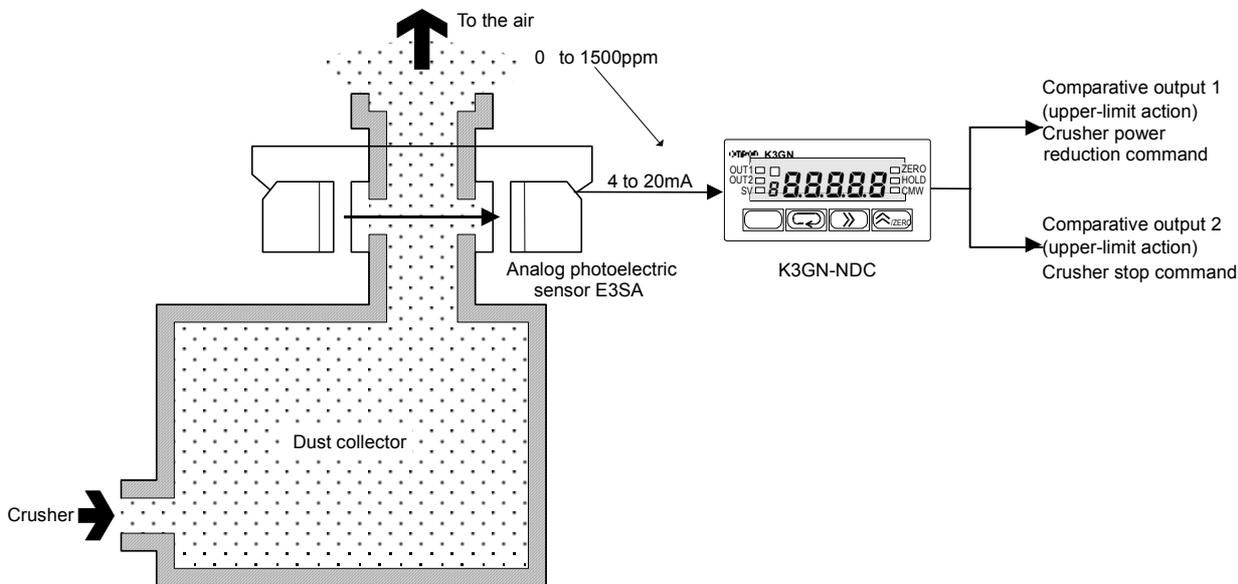

APPLICATION EXAMPLES

- The quantity of dust exhausted from a dust collector into the air is monitored.
- The analog photoelectric sensor E3SA is used to detect the quantity of dust.
- A dust quantity of 0 to 1500 ppm corresponds to an E3SA output of 4 to 20 mA.
- The K3GN indicates the quantity of dust in units of ppm.
- Comparative output 1 is used to generate an upper-limit action signal that reduces the crusher power.
- Comparative output 2 is used to generate another upper-limit action signal that stops the crusher.
- The OUT 1 upper-limit value is 800 ppm and the OUT2 upper-limit value is 1000 ppm.
- Eight measurements are averaged for stable indication.
- The hysteresis is set to 10 for stable output in the vicinity of the OUT set values.

Wiring

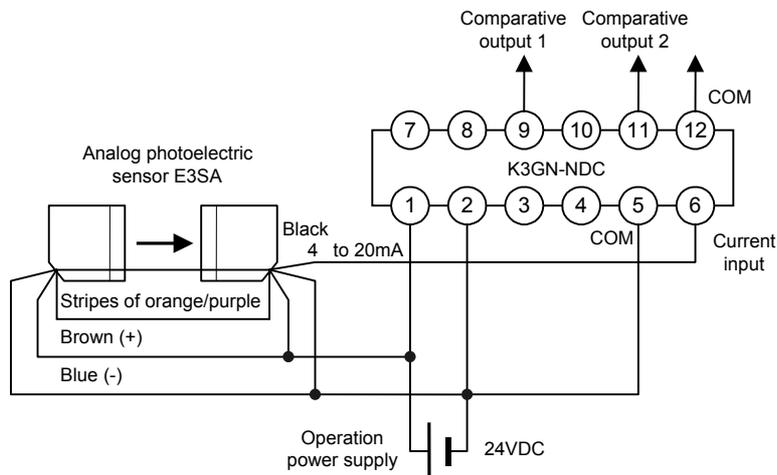

Parameter Setting

Set the parameters of the K3GN as follows.

Level	Parameter	Set value
Initial setting	Unit	PPM
	Range	4-20
	LnP.1	4.00
	dSP.1	0
	LnP.2	20.00
	dSP.2	15.00
	dP	00000
	OUT 1L	HL
	OUT 2L	HL
	Advanced-function setting	ALG
HYS 1		10
HYS 2		10
Operation setting	OUT 1	800
	OUT 2	1000

For details on the parameters, refer to **CHAPTER 5 OPERATION**.

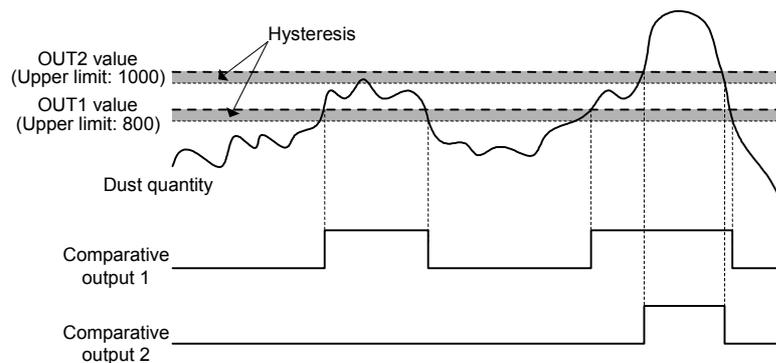
Operation

- Comparative output 1 turns on when the dust quantity reaches 800 ppm.
- When comparative output 1 turns on, the crusher power is reduced until the dust quantity decreases to within the specified range.
- Comparative output 2 turns on when an accident causes a sudden increase in dust quantity to 1000 ppm.
- When comparative output 2 turns on, it provides an emergency stop to the crusher.

3.4 Monitoring the Internal Pressure of a Tank

Application

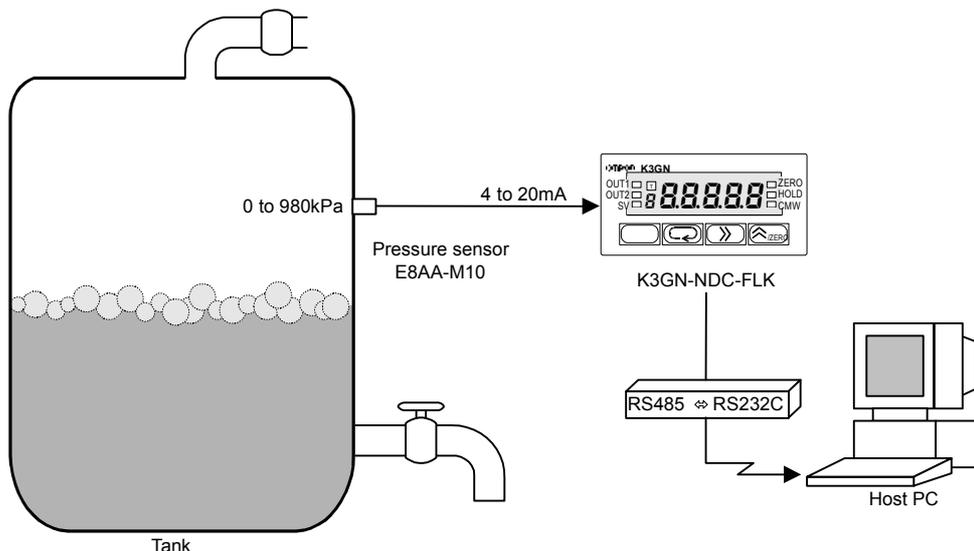

- The internal pressure of a tank is monitored.
- The pressure sensor E8AA-M10 is used to detect the pressure in the tank.
- A pressure of 0 to 980 kPa corresponds to an E8AA-M10 output of 4 to 20 mA.
- The K3GN indicates the pressure in units of kPa to one decimal place.
- The communication function of the K3GN enables remote monitoring of the pressure on the host PC.
- The status of comparative outputs is read by the host PC at a remote site.
- Comparative output 1 turns on when the pressure reaches 550.0 kPa, which generates an upper-limit action signal.
- Comparative output 2 turns on when the pressure decreases to 100.0 kPa, which generates a lower-limit action signal.

Wiring

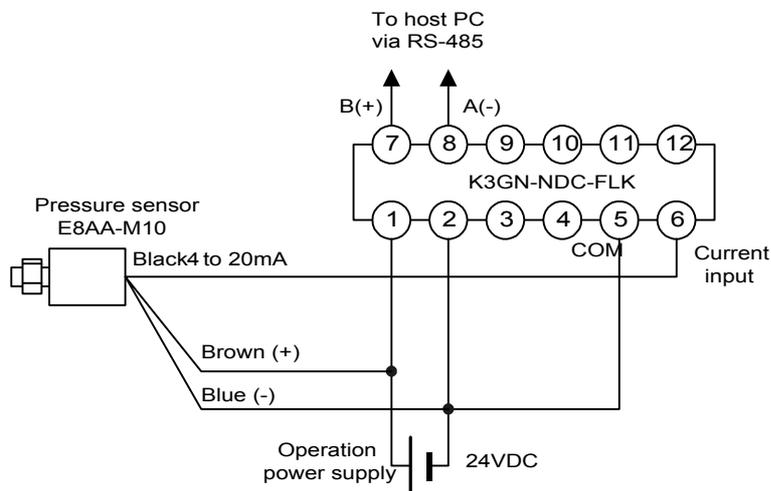

Parameter Setting

Set the parameters of the K3GN as follows.

Level	Parameter	Set value
Initial setting	Unit	ANALG
	Range	4-20
	LnP.1	4.00
	dSP.1	0
	LnP.2	20.00
	dSP.2	9800
	dP	0000.0
	Out 1t	HL
	Out 2t	L0
Communication setting	U-n0	1
	bPS	9.6
	LEn	7
	Sbct	2
	PrtY	EuEn
Operation setting	Out 1	550.0
	Out 2	100.0

Set the communication parameters according to the host PC setting.
For details on the parameters, refer to **CHAPTER 5 OPERATION**.

Operation

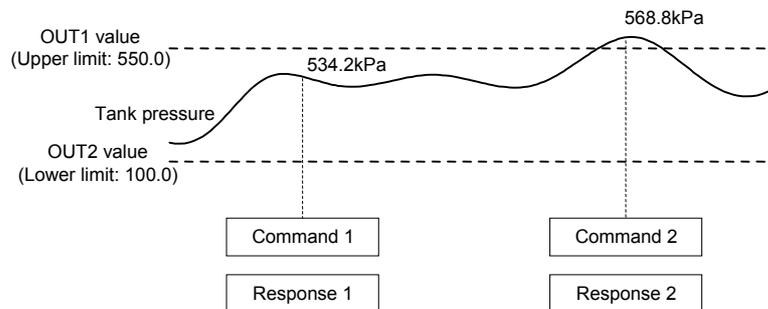

	MRC	SRC	Variable type	Address	Bit position	No. of elements
Command 1	"01"	"01"	"C0"	"0001"	"00"	"0002"
Response 1	"01"	"01"	Response code	Current value		Status
	"01"	"01"	"0000"	"000014DE"		"00000400"
14DEH (5342 in decimal) (PASS output ON)						
	MRC	SRC	Variable type	Address	Bit position	No. of elements
Command 2	"01"	"01"	"C0"	"0001"	"00"	"0002"
Response 2	"01"	"01"	Response code	Current value		Status
	"01"	"01"	"0000"	"00001638"		"00000100"
1638H (5688 in decimal) (Comparative output 1 ON)						

- The host PC reads the current value and the status from the K3GN at regular intervals.

Of command and response frames, only text fields are shown in the above figure.
For details on communications, refer to **CHAPTER 7 COMMUNICATIONS**.

3.5 Monitoring the Rotational Speed of a Motor

Application

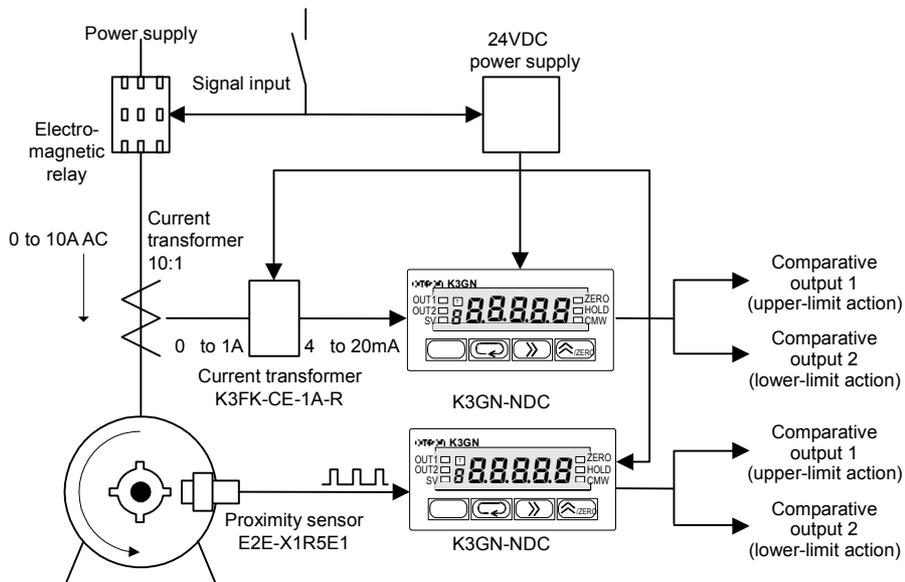

- In addition to the load current monitored in the application shown in Section 3.2, the rotational speed of a motor is also monitored with an additional K3GN.
- A four-toothed wheel is installed on the motor shaft to allow detection of its rotational speed.
- The proximity sensor E2E-X1R5E1 converts motor shaft rotations to on/off pulses.
- The K3GN indicates the rotational speed in terms of rpm.
- A startup compensation timer is used to prevent superfluous output from being produced until the motor reaches a designated speed (for five seconds after startup).
- Comparative output 1 is used to generate an upper-limit action signal. Comparative output 2 is used to generate a lower-limit action signal.
- The OUT1 upper-limit value is set to 3500 rpm and the OUT2 lower-limit value to 1000 rpm.
- The auto-zero function is used to enhance the lower-limit response. (A speed of 150 rpm or less is automatically shifted to zero).

Wiring

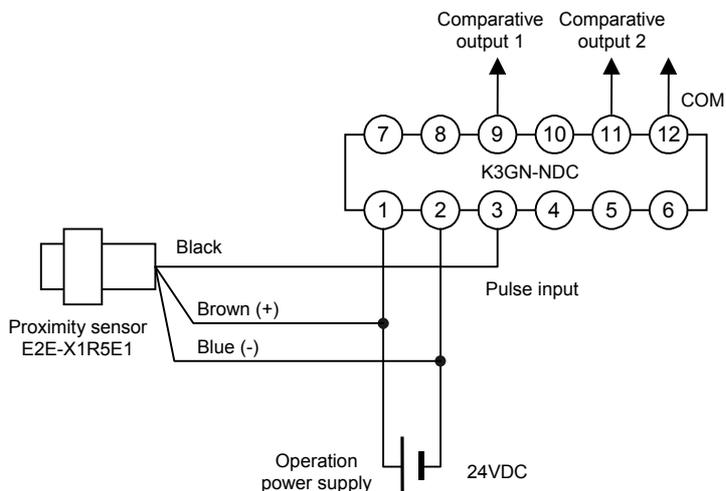

Parameter Setting

Set the parameters of the K3GN as follows.

Level	Parameter	Set value
Initial setting	Ln-t	PULSE
	P-FrE	5P
	LnP	1000
	dSP	15000
	dP	00000
	OUT 1t	HZ
Advanced-function setting	OUT 2t	L0
	OUT 3t	0.1
Operation setting	S-tAr	5.0
	OUT 1	3500
	OUT 2	1000

For details on the parameters, refer to **CHAPTER 5 OPERATION**.

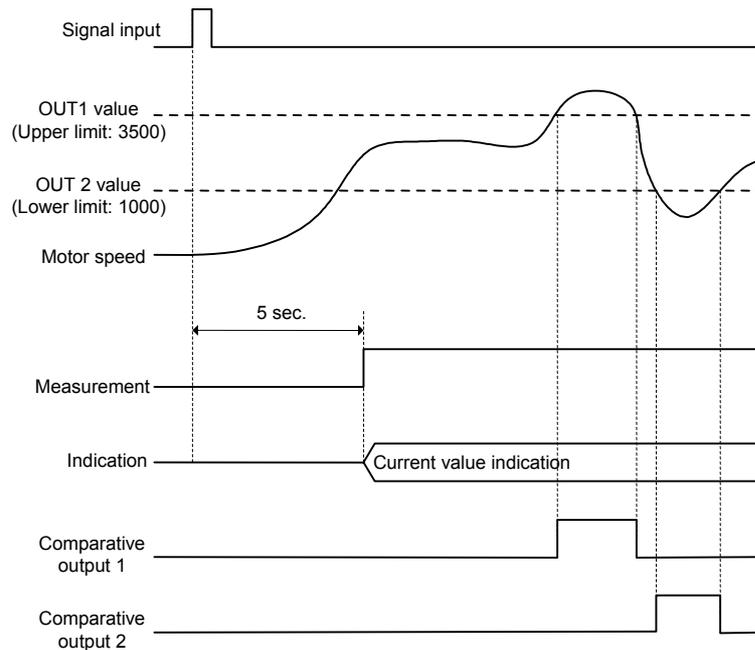
Operation

- The startup compensation timer works for five seconds after the motor power is turned on. This prevents superfluous output from being produced by the K3GN.
- Comparative output 1 turns on when the motor speed reaches 3500 rpm. Comparative output 2 turns on when the motor speed decreases to 1000 rpm.

3.6 Using the Product as a Digital Indicator for PLC

Application

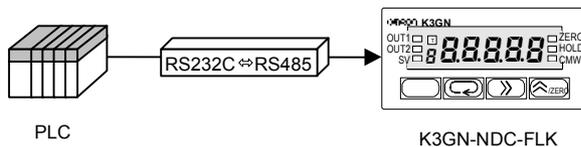

- The K3GN is used as a digital indicator for PLC data.
- The display color of the K3GN main indicator is set to “always green”.
- The process value is displayed without scaling.

Wiring

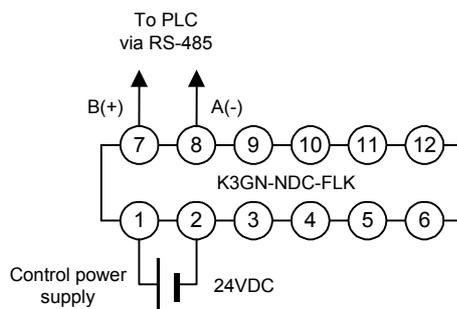

Parameter Setting

Set the parameters of the K3GN as follows.

Level	Parameter	Set value
Initial setting	$\bar{L}n-k$	$r\bar{n}k$
	$\bar{L}nP.1$	19999
	$dSP.1$	19999
	$\bar{L}nP.1$	99999
	$dSP.1$	99999
	dP	00000
Communication setting	$U-n\bar{a}$	1
	bPS	9.6
	LEn	7
	$Sb\bar{L}k$	2
	$PrtY$	$EuEn$
Advanced-function setting	$\bar{L}\bar{a}L\bar{a}r$	$\bar{U}rn$

Set the communication parameters according to the host PC setting
 For details on the parameters, refer to **CHAPTER 5 OPERATION**.

Operation

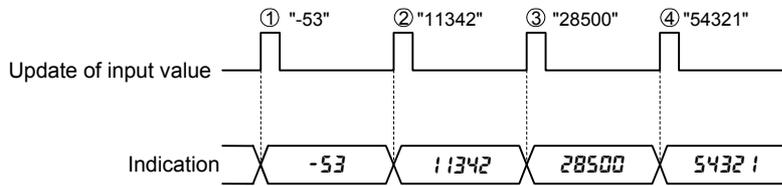

	MRC	SRC	Variable type	Address	Bit position	No. of elements	Current value
Command①	"01"	"02"	"C2"	"0000"	"00"	"0001"	"FFFFFFCB" FFFFFFCBH (-53 in decimal)
Command②	"01"	"02"	"C2"	"0000"	"00"	"0001"	"00002C4E" 2C4EH (11342 in decimal)
Command③	"01"	"02"	"C2"	"0000"	"00"	"0001"	"00006F54" 6F54H (28500 in decimal)
Command④	"01"	"02"	"C2"	"0000"	"00"	"0001"	"0000D431" D431H (54321 in decimal)

CHAPTER

4

INITIAL SETTING

Typical applications of the product include a process meter, a tachometer, or an indicator of digital data from PLC/PC.

This chapter explains the flow of initial setting for each of these applications.

4.1	Using the Product as a process meter.....	30
4.2	Using the Product as a Tachometer	32
4.3	Using the Product as a Digital Indicator	34

4.1 Using the Product as a process meter

The following example shows the flow of initial setting for the product that is used as a process meter.

Setting example:

Input signals ranging from 1 to 5V is scaled to readouts ranging from 0 to 100 kg.

Comparative output 1 is produced when the process value (readout) reaches 70.0 kg.

Comparative output 2 is produced when the process value (readout) decreases to 50.0 kg.

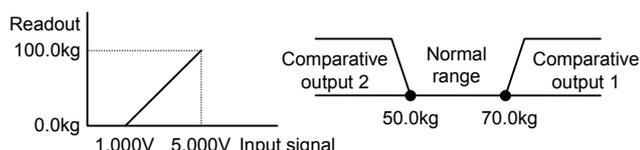

Flow of Initial Setting

A. Check wiring for correct connection and power the product on.

The product is factory set to have an analog input range of 4 to 20 mA. If an input that falls outside this default range is received, the main indicator of the product will read “5.E.r.r” and blink, indicating an “input range over” error occurs.

Note

The input type, analog range, scaling factor, and decimal point position should be set in this order.

Otherwise, auto-initialization of parameters may result in a failure in parameter setting. If you specify the scaling factor and then the input type, for example, the analog range and the scaling factor are initialized automatically.

B. Set “input type” to “analog”.

1. Make sure the main indicator displays a process value (the product is at the operation level).

Then press the key and hold it down for at least one second. The product will move to the initial setting level.

2. Set parameter “I n - t” to “A n a l o g”.

C. Set “analog range” to “1 ~ 5V”.

1. Set parameter “r a n g e” to “1 - 5”.

D. Specify the scaling factor.

1. Set parameter “I n P . 1” to “1.000”.

2. Set parameter “d s p . 1” to “0”.

3. Set parameter “I n P . 2” to “5.000”.

4. Set parameter “d s p . 2” to “1000”.

E. Specify the decimal point position.

1. Set parameter “d p” to “0000.0”.

F. Set “OUT1 value type” to “upper limit” and “OUT2 value type” to “lower limit”.

1. Set parameter “OUT1” to “HL”.
2. Set parameter “OUT2” to “LO”.

G. Set the OUT1 value to “70.0” and the OUT2 value to “50.0”.

1. Make sure the main indicator displays an initial setting level parameter (the product is at the initial setting level).
Then press the key and hold it down for at least one second.
The product will move to the operation level.
2. Set parameter “OUT1” to “70.0”.
3. Set parameter “OUT2” to “50.0”.

TIPS

The number of measurements for averaging and the hysteresis can be changed if required. These parameters are to be set at the advanced-function setting level.

H. Bring the product into measuring operation.

Clear All

If you are confused about how parameters have been set during initial setting, you can clear all the parameters and start all over again.

For details on how to clear all parameters, refer to **Section 5.16 Clearing All Parameters**.

For details on parameter setting, refer to **CHAPTER 5 OPERATION**.

4.2 Using the Product as a Tachometer

The following example shows the flow of initial setting for the product that is used as a tachometer.

Setting example:

The speed of a conveyor belt is indicated in terms of m/min.
 Four pulses are generated per rotation of the rotor.
 The diameter of the rotor is 12 cm.
 Comparative output 1 is produced when the speed reaches 10500 m/min.
 Comparative output 2 is produced when the speed decreases to 9500 m/min.

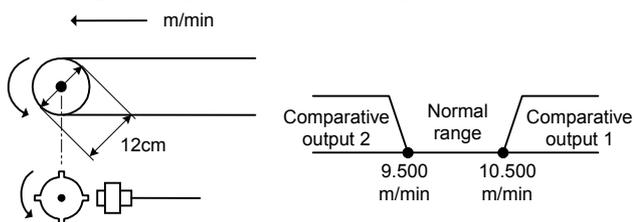

How to Determine the Scaling Factor

Determine the scaling factor as follows.

$$\begin{aligned} \text{Rotor rotational speed (rpm)} \\ &= \text{Input frequency (Hz)} / \text{Number of pulses per rotation} \times 60 \end{aligned}$$

$$\begin{aligned} \text{Belt Speed (m/min)} \\ &= \pi \times \text{Rotor diameter (m)} \times \text{Rotor rotational speed (rpm)} \end{aligned}$$

Hence the belt speed is given as

$$\begin{aligned} \text{Belt speed (m/min)} &= 3.14159... \times 0.12 \times 60/4 \times \text{Input frequency (Hz)} \\ &= 5.654866... \times \text{Input frequency (Hz)} \end{aligned}$$

Multiply the result by 1000 to enable a readout to be displayed to three decimal places.

$$\text{Belt speed (m/min)} = 5654.866... \times \text{Input frequency (Hz)}$$

To minimize the scaling operation error, select such an input frequency that allows readouts to contain the largest possible number of digits. In this example, the input frequency is set to 10 Hz so that the readout is 56549.

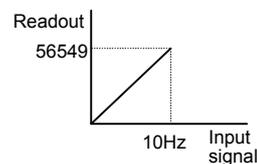

Flow of Initial Setting

- A.** Check wiring for correct connection and power the product on.

The product is factory set to have an analog input range of 4 to 20 mA. If an input that falls outside this default range is received, the main indicator of the product will read “**S.E.R.R**” and blink, indicating an “input range over” error occurs.

Note

The input type, pulse frequency, scaling factor, and decimal point position should be set in this order. Otherwise, auto-initialization of parameters may result in a failure in parameter setting. If you specify the scaling factor and then the input type, for example, the pulse frequency and the scaling factor are initialized automatically.

B. Set “input type” to “pulse”.

1. Make sure the main indicator displays a process value (the product is at the operation level).
Then press the key and hold it down for at least one second.
The product will move to the initial setting level.
2. Set parameter “ $\bar{I}n-t$ ” to “*PULSE*”.

C. Set “pulse frequency” to “30 Hz”.

1. Set initial setting level parameter “*P-FrE*” to “*30*”.
This is because this application is expected to involve an input frequency of approx. 2 Hz and not more than 30 Hz.

D. Specify the scaling factor.

1. Set parameter “ $\bar{I}nP$ ” to “*10.00*”.
2. Set parameter “*dSP*” to “*55549*”.

E. Specify the decimal point position.

1. Set parameter “*dP*” to “*00.000*”.

F. Set “OUT1 value type” to “upper limit” and “OUT2 value type” to “lower limit”.

1. Set parameter “ $\bar{O}Ut 1t$ ” to “*HL*”.
2. Set parameter “ $\bar{O}Ut 2t$ ” to “*Ll*”.

G. Set the OUT1 value to “10.500” and the OUT2 value to “9.500”.

1. Make sure the main indicator displays an initial setting level parameter (the product is at the initial setting level).
Then press the key and hold it down for at least one second.
The product will move to the operation level.
2. Set parameter “ $\bar{O}Ut 1$ ” to “*10.500*”.
3. Set parameter “ $\bar{O}Ut 2$ ” to “*9.500*”.

H. Bring the product into measuring operation.**TIPS**

The number of measurements for averaging and the hysteresis can be changed if required.
These parameters are to be set at the advanced-function setting level.

Clear All

If you are confused about how parameters have been set during initial setting, you can clear all the parameters and start all over again.

For details on how to clear all parameters, refer to **Section 5.16 Clearing All Parameters**.

For details on parameter setting, refer to **CHAPTER 5 OPERATION**.

4.3 Using the Product as a Digital Indicator for PLC Data

The following example shows the flow of initial setting for the product that is used as a digital indicator for PLC data.

Setting example:

Full span 0H to 0FA0H (0 to 4000 in decimal) of a PLC analog input unit is scaled to 80.0 to 120.0 mm and displayed.

Comparative output 1 is produced when the process value reaches 110.0 mm. Comparative output 2 is produced when the process value decreases to 90.0 mm.

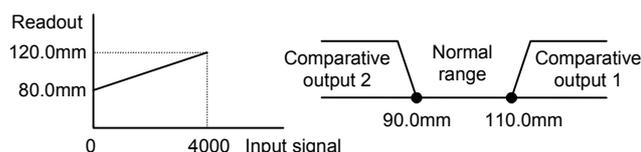

Flow of Initial Setting

A. Check wiring for correct connection and power the product on.

The product is factory set to have an analog input range of 4 to 20 mA. If an input that falls outside this default range is received, the main indicator of the product will read “*S.E.R.R*” and blink, indicating an “input range over” error occurs..

B. Set “input type” to “remote”.

1. Make sure the main indicator displays a process value (the product is at the operation level).
Then press the key and hold it down for at least one second.
The product will move to the initial setting level.
2. Set parameter “*ĩn-t*” to “*rñt*”.

C. Specify the scaling factor.

1. Set parameter “*ĩnP.1*” to “*0*”.
2. Set parameter “*dSP.1*” to “*800*”.
3. Set parameter “*ĩnP.2*” to “*4000*”.
4. Set parameter “*dSP.2*” to “*1200*”.

D. Specify the decimal point position.

1. Set parameter “*dP*” to “*0000.0*”.

E. Set “OUT1 value type” to “upper limit” and “OUT2 value type” to “lower limit”.

1. Set parameter “*õut 1t*” to “*Hĩ*”.
2. Set parameter “*õut 2t*” to “*Lõ*”.

TIPS

Setting “input type” to “remote” sets the adjustment level parameter “downloading (communication writing)” to “enable” automatically. The “CMW” indicator on the front panel will be illuminated.

Note

The input type, scaling factor, and decimal point position should be set in this order. Otherwise, auto-initialization of parameters may result in a failure in parameter setting. If you specify the scaling factor and then the input type, for example, the scaling factor is initialized automatically.

F. Specify communication parameters.

1. Make sure the main indicator displays an initial setting level parameter. Then press the key. The product will move to the communication setting level.
2. Set parameter “*U-ID*” as appropriate. Exercise care to avoid assigning the same ID number to more than one K3GN when connecting multiple products to one host PC.
3. Set parameter “*bPS*” to the same value as in the host PC.
4. Set parameter “*LEN*” to the same value as in the host PC.
5. Set parameter “*SBCT*” to the same value as in the host PC.
6. Set parameter “*PRTY*” to the same value as in the host PC.

G. Set the OUT1 value to “110.0” and the OUT2 value to “90.0”.

1. Make sure the main indicator displays an initial setting level parameter. Then press the key and hold it down for at least one second. The product will move to the operation level.
2. Set parameter “*OUT1*” to “110.0”.
3. Set parameter “*OUT2*” to “90.0”.

TIPS

The number of measurements for averaging and the hysteresis can be changed if required. These parameters are to be set at the advanced-function setting level.

H. Bring the product into measuring operation.**Clear All**

If you are confused about how parameters have been set during initial setting, you can clear all the parameters and start all over again. For details on how to clear all parameters, refer to **Section 5.16 Clearing All Parameters**.

For details on parameter setting, refer to **CHAPTER 5 OPERATION**.

5.1 Levels

In this manual, setting items of the product are grouped into seven levels as follows.

Level	Description	Measurement
Protect	This level allows parameter setting for protection against unauthorized or inadvertent key operation. Access to protected levels or setting items is disabled.	Yes
Operation	This level represents the normal operation state in which the product can accept input signals and provide comparative outputs. Not only readout of the current process value but also access to or changes of OUT set values are allowed at this level. The product enters this level at power-on.	Yes
Adjustment	This level permits communication writing to be enabled or disabled. Even if communication writing is disabled, reading is always enabled. If your product has no communication function, this level is not available.	Yes
Initial setting	This level allows initial setting of the input type, analog range, scaling factor and the like. Available only for the product with communication function.	No
Communication setting	This level allows setting of the baud rate, word length and other communication parameters. Available only for the product with communication function	No
Advanced-function setting	This level allows setting of the number of measurements for averaging. Customizations such as a change in display color are also possible at this level.	No
Calibration	This level allows user calibration. Note that user calibration could cause deterioration in measuring accuracy of the product.	No

During operation of the product, the level indicator designates the current level. Alphabetic characters shown on the level indicator and their corresponding levels are shown below.



Alphabetic character	Level
<i>P</i>	Protect level
(OFF)	Operation level
<i>A</i>	Adjustment level
<i>S</i>	Initial Setting level
<i>C</i>	Communication level
<i>F</i>	Advanced-Function level
<i>U</i>	User calibration level

5.2 Moving among Levels

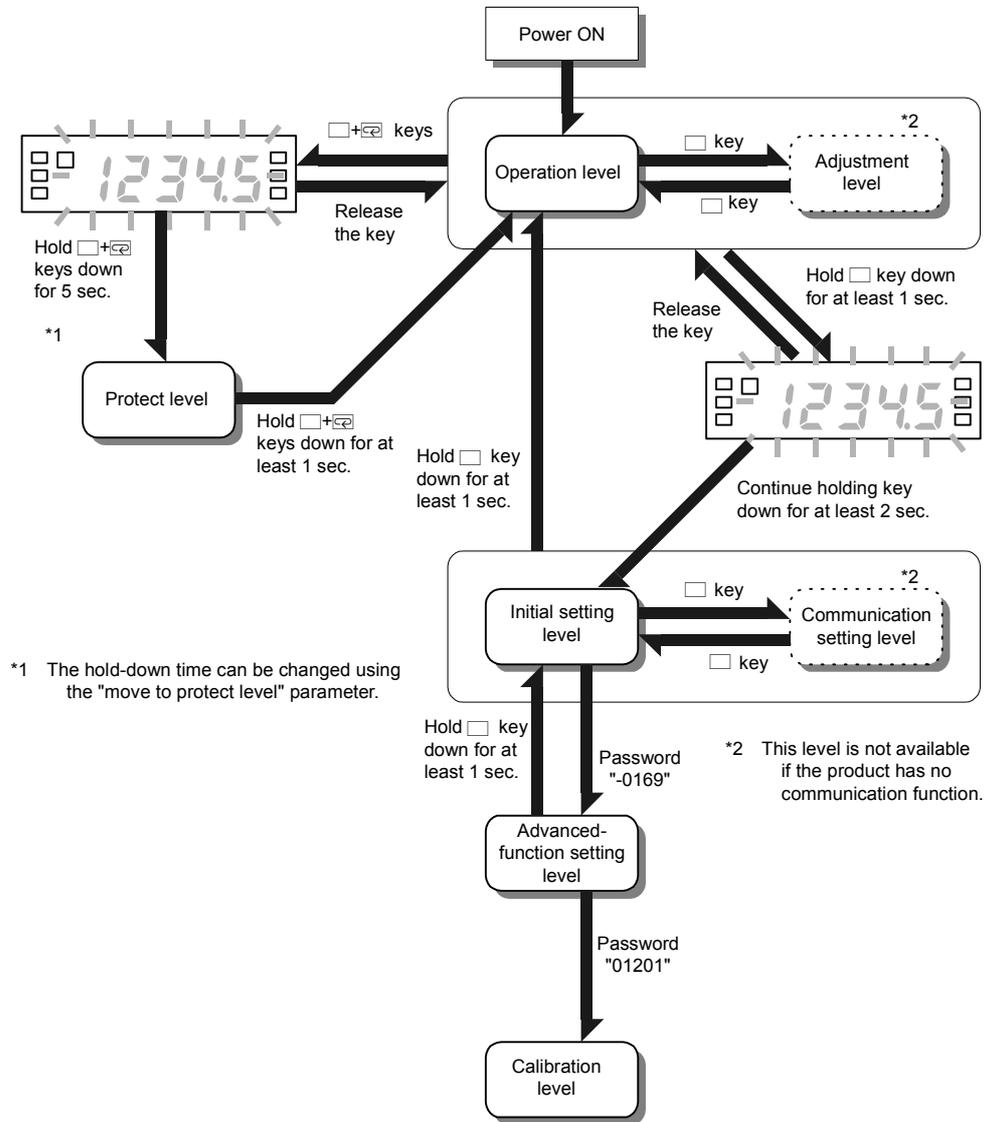

*1 The hold-down time can be changed using the "move to protect level" parameter.

*2 This level is not available if the product has no communication function.

Power the product off and then on again to exit from calibration level.

Moving to the protect level

Press the + keys simultaneously and hold them down for at least 5 seconds. The main indicator starts blinking and then the product enters the protect level. The time required for moving to the protect level can be changed using the “move to protect level” parameter at the advanced-function setting level.

To return from the protect level to the operation level, press the + keys simultaneously and hold them down for at least one second.

Moving to the adjustment level

Press the key at the operation level.

When you release the key, the product enters the adjustment level.

To return from the adjustment level to the operation level, press the key.

Moving to the initial setting level

Press the key and hold it down for one second.

The main indicator starts blinking.

Continues holding the key down further for at least two seconds.

The product will return to the initial setting level.

To return from the initial setting level to the operation level, press the key and hold it down for at least one second.

Moving to the communication setting level

Press the key at the initial setting level. (Release the key within one second).

When you release the key, the product enters the communication setting level.

To return from the communication setting level to the initial setting level, use the key.

Moving to the advanced-function setting level

Moving to the advanced-function setting level involves some particular steps.

Proceed as follows.

Procedure

A. Move to the initial setting level and press the key to display the "advanced-function setting level" parameter.

- Parameter “*アノブ*” will appear on the main indicator.

B. Press the key to cause "0" to appear on the main indicator.

C. Press the key again to allow the password to be changed.

D. Use the and keys to enter a password of “-0169”.

E. Press the  key to save the password.

- If the password is correct, the product enters the advanced-function setting level.
- If the password is incorrect, the product remains at the initial setting level and its main indicator displays the next initial setting parameter.

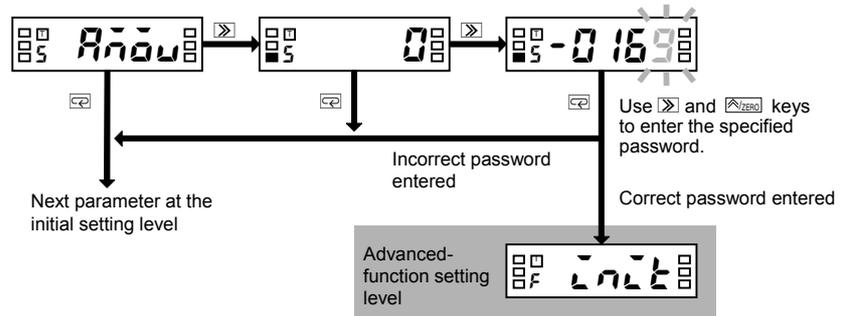

5.3 Parameters

Setting items at each level are called “parameters”.

Use the  key to select a parameter.

If the input range is changed, some parameters are set to default values.

Therefore, set the input range first.

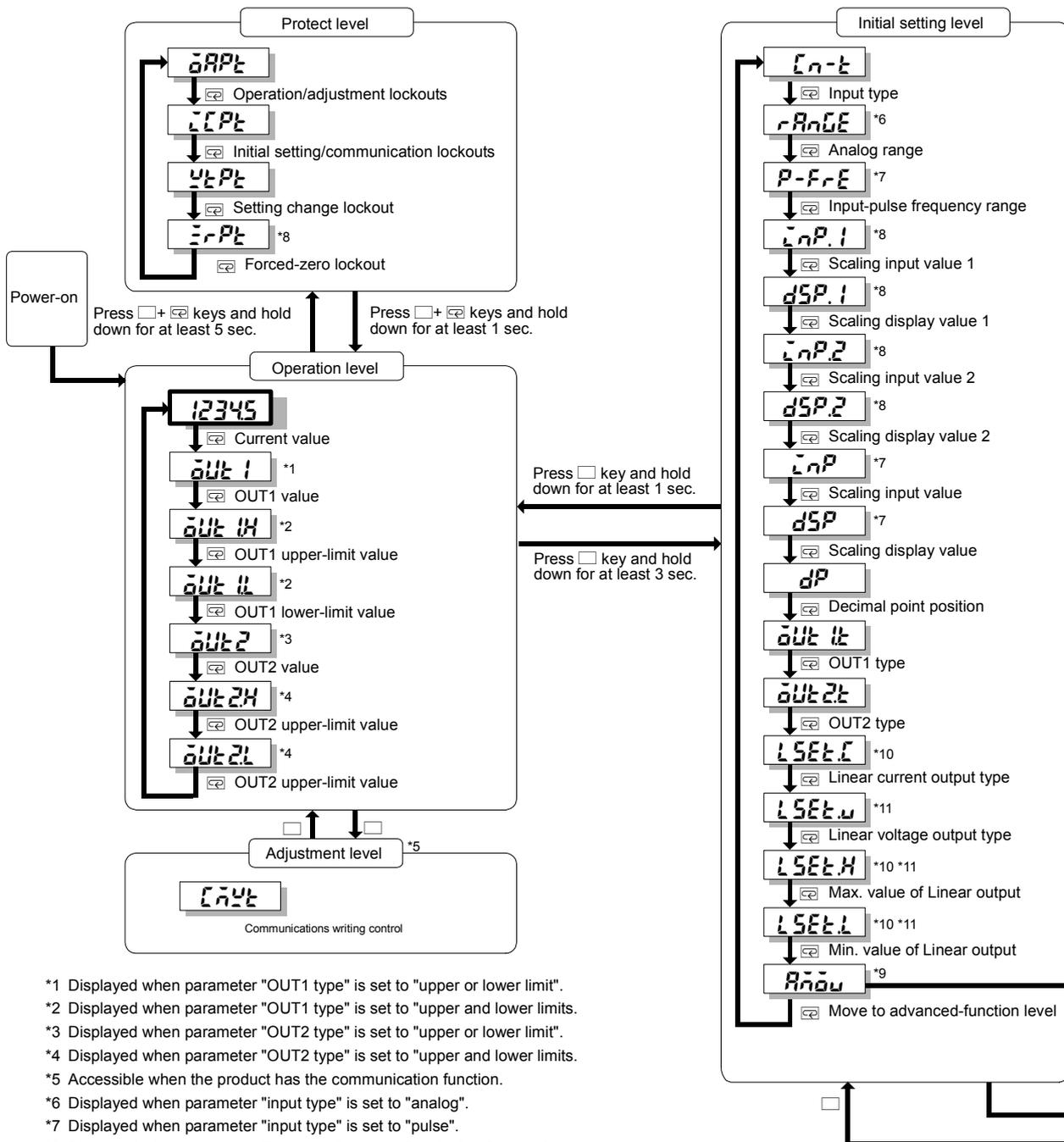

- *1 Displayed when parameter "OUT1 type" is set to "upper or lower limit".
- *2 Displayed when parameter "OUT1 type" is set to "upper and lower limits".
- *3 Displayed when parameter "OUT2 type" is set to "upper or lower limit".
- *4 Displayed when parameter "OUT2 type" is set to "upper and lower limits".
- *5 Accessible when the product has the communication function.
- *6 Displayed when parameter "input type" is set to "analog".
- *7 Displayed when parameter "input type" is set to "pulse".
- *8 Displayed when parameter "input type" is set to "analog" or "remote".
- *9 Displayed when parameter "initial setting/communication lockouts" is set to "0".
- *10 Displayed for models with linear current output.
- *11 Displayed for models with linear voltage output.

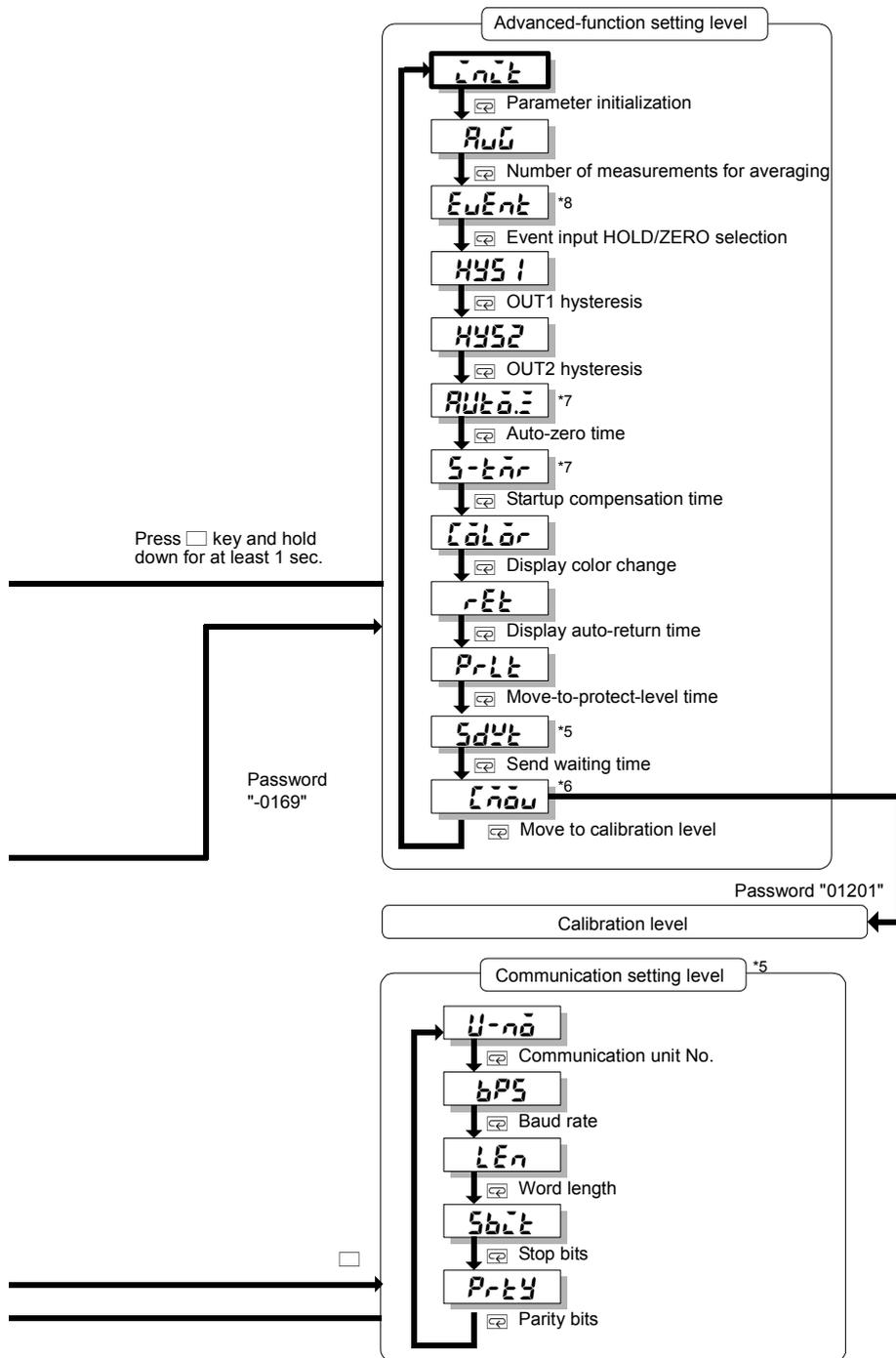

5.4 Set Values

Parameter settings are called “set values”.
Set values include those consisting of “numerics” and “alphabets”.

A state in which a set value is being displayed on the main indicator is called “the monitor state”.

A state in which a set value can be changed is called “the change state”.

Perform the following steps to display or change a set value.

Procedure

A. Press the  key when a parameter is displayed on the main indicator. The product enters the monitor state and the set value of the parameter will be displayed on the main indicator.

- When the product is in the monitor state, “SV” in the operation indicator section is illuminated, indicating the readout on the main indicator is a set value.

B. If you do not want to change the set value, press the  key in the monitor state to go to the next parameter.

C. Press the  key in the monitor state to cause the product to enter the change state.

- A digit that can be changed will start blinking.

D. Use the  and  key to change the set value.

- If no key is operated for five seconds, the product saves the current value and returns to the monitor state automatically.

E. Press the  key to go to the next parameter.

- The change in setting is saved in memory.

TIPS

During setting of operation or adjustment level parameters, the return action of the product varies depending on the “display auto-return time” setting.

The display auto-return time defaults to ten seconds. If the “display auto-return time” is set to less than five seconds, e.g., three seconds, no key operation for three seconds in the change state will return the product to the current value display mode, not to the monitor state.

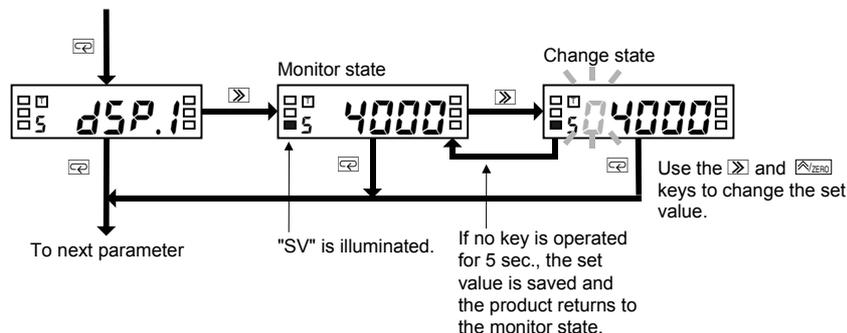

5.5 Operation Level

Operation Level

■ Viewing and Changing OUT set values

OUT 1

OUT 1.H

OUT 1.L

OUT 2

OUT 2.H

OUT 2.L

The operation level allows you to check and change OUT set values.

The product continues measuring in the middle of checking and changing OUT set values.

Procedure

A. Press the  key several times until parameter OUT2 is displayed on the main indicator.

B. Press the  key to display the OUT2 value on the main indicator.

- The product enters the monitor state and shows the OUT2 value on the main indicator.
- “SV” in the operation indicator section is illuminated, indicating the value shown on the main indicator is a set value.
- If you simply want to check the set value, proceed to step **E**.

C. Press the  key in the monitor state to cause the product to enter the change state.

- A digit that can be changed will start blinking.

D. Use the  and  key to change the set value.

- If no key is operated for five seconds, the product saves the current value and returns to the monitor state automatically.

E. Press the  key several times to return to the current value display mode.

- The change in setting is saved in memory.

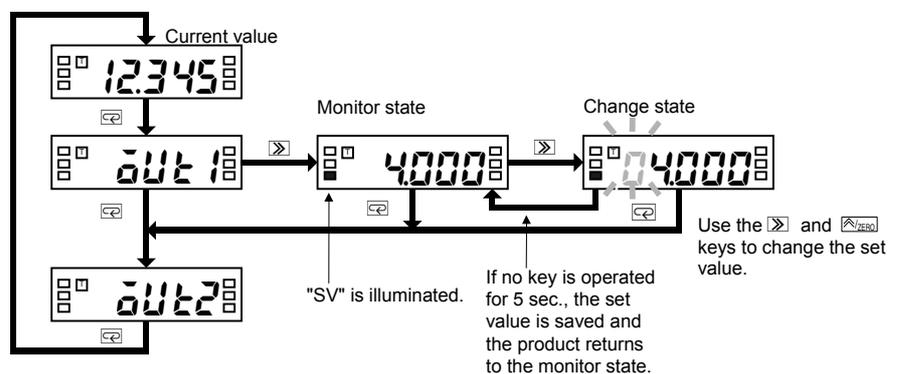

Available OUT set values and their indications are as follows.

OUT set value	Indication	Description
OUT1 value	OUT 1	When the process value increases or decreases to this value, comparative output 1 is provided.
OUT1 upper-limit value	OUT 1H	When the process value falls outside the range specified by these values, comparative output 1 is provided.
OUT1 lower-limit value	OUT 1L	
OUT2 value	OUT 2	When the process value increases or decreases to this value, comparative output 2 is provided.
OUT2 upper-limit value	OUT 2H	When the process value falls outside the range specified by these values, comparative output 2 is provided.
OUT2 lower-limit value	OUT 2L	

■ Forced-zero operation

Note

The forced-zero operation is not available if the input type is set to "pulse".

The forced-zero operation allows you to shift the current value to zero forcibly. For details, refer to **CHAPTER 6 FUNCTION DESCRIPTION**.

Procedure (for forced-zero operation)

A. Press the  key when a current value is displayed on the main indicator. (Release the key within one second).

- The current value will be shifted to zero.
- "ZERO" in the operation indicator section is illuminated, indicating the current value has been shifted to zero.

Procedure (for forced-zero release operation)

B. Press the  key and hold it down for at least one second when a shifted value is displayed.

- The shifted value will be restored to the current value.
- "ZERO" in the operation indicator section will go off, indicating the current value is no longer shifted.

TIPS

If the  key on the front panel is used for executing the forced-zero operation, the forced-zero process is stored in EEPROM. But if the forced-zero operation is executed via the event input terminal or communications, the process is not stored.

If the current value is not normal (e.g., the input signal is invalid, the process value is outside the displayable range, or no measurements are made), the forced-zero function is inoperative.

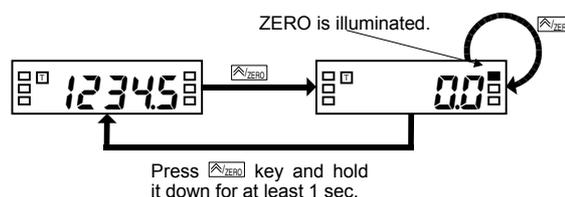

5.6 Communication Writing Control

Adjustment level



(CMWT)

Communication writing can be enabled or disabled.

Communication reading is always enabled, irrespective of this parameter setting.

Parameter	Set value	Description
CnYt	OFF	Communication writing is disabled.
	ON	Communication writing is enabled.

Procedure

TIPS

No operation for ten seconds at the adjustment level causes the product to return to the current value display mode at the operation level automatically.

A. Press the key at the operation level to move to the adjustment level.



"r" appears.

- "r" will appear on the level indicator, indicating the product has entered the adjustment level.

B. Press the key to display the set value of the parameter on the main indicator.



"SV" is illuminated.

- The current set value will appear on the main indicator.

C. Press the key again.



- The set value will start blinking, indicating the product is in the change state.

D. Use the /ZERO key to change the set value.

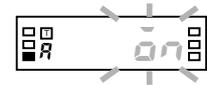

E. Press the key to save the change.



- The change is saved and then the main indicator returns to the parameter display mode.

F. Press the key to return to the operation level.



5.7 Key Protect Setting

Protect level



Key protect includes “operation/adjustment lockouts”, “initial setting/communication lockouts”, “setting change lockout” and “forced-zero lockout”, and allows restrictions on various setting changes.

Operation/ Adjustment Lockouts

This types of key protect restrict the key operation at the operation and adjustment levels.

Parameter	Set value	Operation level		Move to adjustment level
		Current value display	OUT set value display	
0APt	0	Enable	Enable	Enable
	1	Enable	Enable	Disable
	2	Enable	Disable	Disable

Initial Setting/ Communication Lockouts

This types of key protect restrict the "moving among levels" operation.

Parameter	Set value	Move to initial setting level	Move to communication setting level	Move to advanced-function setting level
1CPt	0	Enable	Enable	Enable
	1	Enable	Enable	Disable
	2	Disable	Disable	Disable

Setting Change Lockout

This type of key protect restricts the key operation for setting changes.

It prohibits the product from entering the change state, except that the following operation is allowed.

- Changes in set values of all parameters at the protect level
- Move to the advanced-function level
- Move to the calibration level

Parameter	Set value	Key operation for setting changes
4tPt	0FF	Enable
	0n	Disable

Forces-zero Lockout

This type of key protect restricts the key operation that activates or deactivates the forced-zero function.

It has no effect on forced-zero operation via the event input terminal.

Parameter	Set value	Key operation for activating or deactivating the forced-zero function
3rPt	0FF	Enable
	0n	Disable

TIPS

Appropriate setting of the "move-to-protect-level time" parameter allows you to change the time required for the product to move to the protect level.
The move-to-protect-level time is factory set to 5 seconds.

Procedure

A. When the product is at the operation level, press the + keys and hold them down for at least five seconds to enter the protect level.

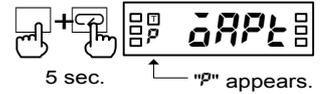

- "P" will appear on the level indicator, indicating the product has entered the protect level.

B. Press the key several times until the desired parameter appears on the main indicator.



C. Press the key to display the set value of the parameter on the main indicator.

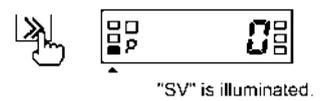

- The current set value will appear on the main indicator.

D. Press the key again.



- The current set value will start blinking, indicating the product is in the change state.

E. Use the key to change the set value.



F. Press the key to go to the next parameter.



- The change is saved.

G. Press the + keys and hold them down for at least one second to return to the operation level.



5.8 Selecting an Input Type

Initial setting level



This parameter allows you to select one from three input types.

Parameter	Set value	Description
In-t	ANALG	Analog: The product can be used as a process meter.
	PULSE	Pulse: The product can be used as a tachometer.
	remt	Remote: The product can be used as a digital data indicator.

Procedure

TIPS

A change in input type initializes some parameters.

- When the input type is set to "analog":

Parameters "InP.1", "dSP.1", "InP.2", "dSP.2" and "dP" are initialized according to the current analog range. The forced-zero function is deactivated.

- When the input type is set to "pulse":

Parameter "dP" is initialized according to the current input-pulse frequency range.

- When the input type is set to "remote":

Parameters "InP.1" and "dSP.1" are set to "-19999" and "InP.2" and "dSP.2" are set to "99999".

Parameter "dP" is set to "00000".

The forced-zero function is deactivated.

Data downloading is set to "enable".

A. When the product is at the operation level, press the key and hold it down for at least three seconds to enter the initial setting level.

- "5" will appear on the level indicator, indicating the product has entered the initial setting level.
- The first parameter at the initial setting level is "In-t".

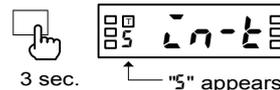

B. Press the key to display the set value of the parameter on the main indicator.

- The current set value will appear on the main indicator.



C. Press the key again.

- The current set value will start blinking, indicating the product is in the change state.



D. Use the key to change the set value.



E. Press the key to go to the next parameter.

- The change is saved.



F. Specify the values of other parameters related to the input type. (Refer to the Appendix).

G. Press the key and hold it down for at least one second to return to the operation level.



5.9 Selecting an Analog Range

Initial setting level

r-RnGE

This parameter allows you to select an analog input range.

Before selecting an analog range, you must set the input type parameter to “analog”.

Parameter	Set value	Measuring range
r-RnGE	4-20	4.00 to 20.00 mA/ 0.00 to 20.00 mA
	1-5	1.000 to 5.000V/ 0.000 to 5.000V
	5	-5.000 to 5.000V
	10	-10.000 to 10.000V

Procedure

TIPS

A change in analog range initializes some parameters.

- Parameters “LrP.1”, “dSP.1”, “LrP.2”, “dSP.2” and “dP” are initialized according to the current analog range. The forced-zero function is deactivated.

A. When the product is at the operation level, press the  key and hold it down for at least three seconds to enter the initial setting level.

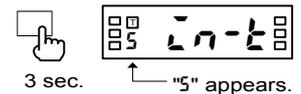

- “5” will appear on the level indicator, indicating the product has entered the initial setting level.

B. Press the  key several times until parameter “r-RnGE” appears on the main indicator.



C. Press the  key to display the set value of the parameter on the main indicator.

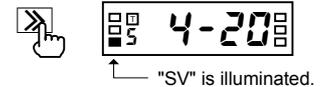

- The set value representing the current analog range will appear on the main indicator.

D. Press the  key again.



- The set value will start blinking, indicating the product is in the change state.

E. Use the  key to change the set value.



F. Press the  key to go to the next parameter.



- The change is saved.

G. Specify the values of other parameters related to the analog range. (Refer to the Appendix).

H. Press the  key and hold it down for at least one second to return to the operation level.



5.10 Selecting an Input-pulse Frequency Range

Initial setting level



This parameter allows you to select an input-pulse frequency range. The value of the parameter represents the upper limit of available ranges.

Before selecting an input-pulse frequency range, you must set the input type parameter to “pulse”.

Parameter	Set value	Description
P-FrE	30	Measuring range: 0.05 to 30.00 Hz
	5K	Measuring range: 0.1 to 5000.0 Hz

If input signals come from relay contacts, set the range to “30 Hz”. Doing so eliminates chattering noise from input signals.

Procedure

TIPS

A change in input-pulse frequency range initializes some parameters.

- Parameters “LnP”, “dSP” and “dP” are initialized according to the current input-pulse frequency range.

A. When the product is at the operation level, press the key and hold it down for at least three seconds.

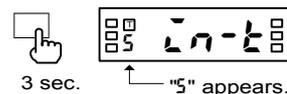

- “5” will appear on the level indicator, indicating the product has entered the initial setting level.

B. Press the key several times until parameter “P-FrE” appears on the main indicator.



C. Press the key to display the set value of the parameter on the main indicator.

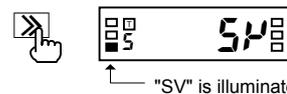

- The current set value of the input-pulse frequency range will appear on the main indicator.

D. Press the key again.



- The set value will start blinking, indicating the product is in the change state.

E. Use the key to change the set value.



F. Press the key to go to the next parameter.



- The change is saved.

G. Specify the values of other parameters related to the input-pulse frequency range. (Refer to the Appendix).

H. Press the key and hold it down for at least one second to return to the operation level.



5.11 Specifying the Scaling Factor for Analog Input/Digital Data Display

Initial setting level

INP.1

dSP.1

INP.2

dSP.2

These parameters allow you to specify the scaling factor.

Before specifying the scaling factor, you must set the input type parameter to “analog” or “remote”.

Parameter	Set value	Description
INP.1	19999 ~ 99999	Any input value
dSP.1	19999 ~ 99999	Output value (readout) corresponding to INP.1
INP.2	19999 ~ 99999	Any input value
dSP.2	19999 ~ 99999	Output value (readout) corresponding to INP.2

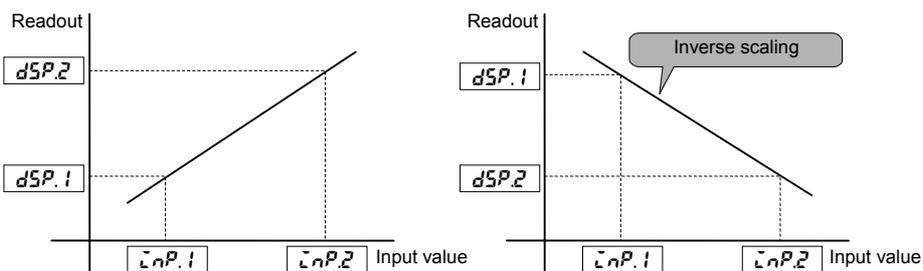

The input value can be set by teaching.

Inverse scaling where readout decreases with increasing input is also possible.

To allow a readout of 0.0 when the input value is 4.2 mA and a readout of 100.0 when the input value is 20 mA, for example, set the parameters as follows.

- INP.1 = 4.20
- dSP.1 = 0
- INP.2 = 20.00
- dSP.2 = 1000

Specify the decimal point position of the display value with parameter dP.

For details, refer to Section 6.2 Scaling.

TIPS

The decimal point position of parameters INP.1 and INP.2 is automatically set as follows.

- When the input type is set to “analog”:
 - 4 to 20 mA: 000.00
 - 1 to 5V: 00.000
 - ±5V: 00.000
 - ±10V: 000.00
- When the input type is set to “remote”:
 - 00000

Procedure

A. When the product is at the operation level, press the key and hold it down for at least three seconds to enter the initial setting level.

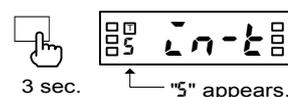

- “5” will appear on the level indicator, indicating the product has entered the initial setting level.

B. Press the key several times until parameter “INP.1” appears on the main indicator.

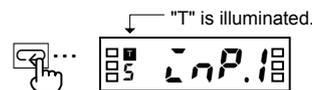

- “T” will be illuminated, indicating teaching of this parameter is possible.
- For the procedure of teaching, refer to the next page.

C. Press the key to display the set value of the parameter on the main indicator.

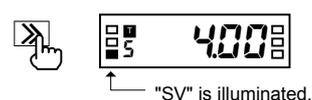

- The current set value of parameter “INP.1” will appear on the main indicator.

OPERATION

- D.** Press the key again.

 - The set value starts blinking, indicating the product is in the change state.
- E.** Use the and keys to change the set value.
- F.** Press the key to go to the next parameter “dSP.1”.

 - The change is saved and then “dSP.1” will appear on the main indicator.
- G.** Repeat steps **C** to **F** for parameters “*z*nP.2” and “dSP.2”.

 - When you finish setting of parameter “dSP.2”, parameter “dP” will appear on the main indicator.
- H.** Press the key and hold it down for at least one second to return to the operation level.

Teaching The teaching function allows you to specify the value of parameters “*z*nP.1” and “*z*nP.2” without the need for any front panel key input.

Procedure

- I.** Following step **C** (the product is in the monitor state), press the key.

 - “T” will start blinking, indicating the product is in teaching mode.
 - Key entry permits the actual process value to be displayed on the main indicator.
- J.** Press the key again.

 - The actual process value is set as the input value and then the product will return to the monitor state.
 - Pressing the key instead of the key in teaching mode cancels the teaching mode and the display on the main indicator changes to the next parameter.

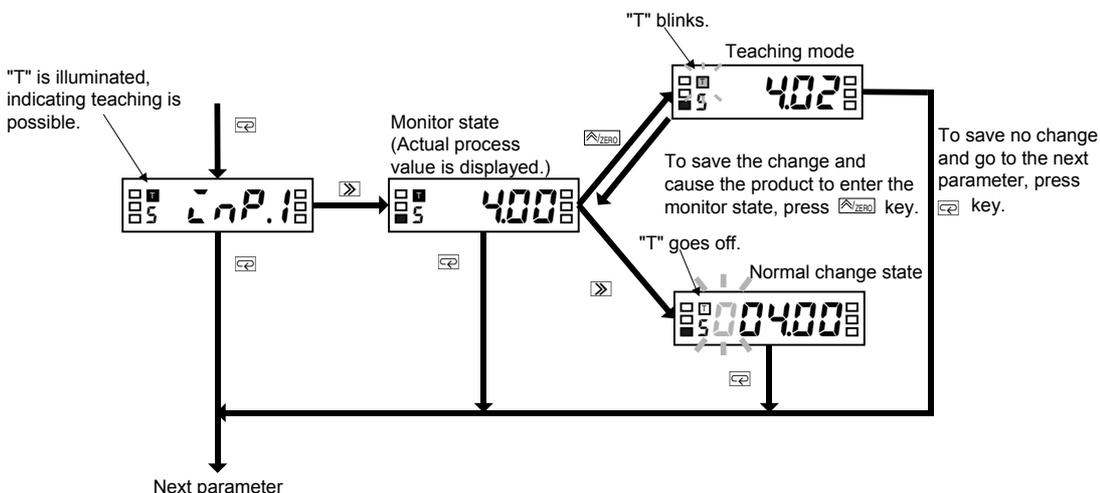

5.12 Specifying the Scaling Factor for Input Pulse Frequency

Initial setting level

These parameters allow you to specify the scaling factor.

Before specifying the scaling factor, you must set the input type parameter to “pulse”.

Parameter	Set value	Description
$\bar{L}nP$	19999 ~ 99999	Any input value
dSP	19999 ~ 99999	Output value (readout) corresponding to $\bar{L}nP$

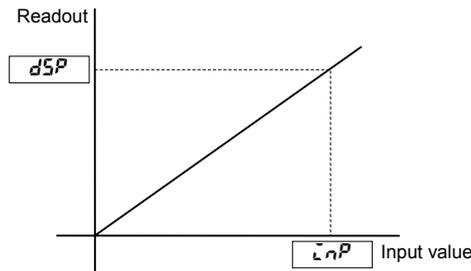

The input value can be set by teaching.

To allow a readout of 10.000 when the input value is 4.2 kHz (= 4200 Hz), for example, set the parameters as follows.

- $\bar{L}nP = 4200$
- $dSP = 10000$

Specify the decimal point position of the display value with parameter dP .

For details, refer to **Section 6.2 Scaling**.

TIPS

The decimal point position of parameter “ $\bar{L}nP$ ” is automatically set depending on setting of the input-pulse frequency range as follows.

30 Hz: 000.00
5 kHz: 00000

Procedure

- A.** When the product is at the operation level, press the key and hold it down for at least three seconds to enter the initial setting level.

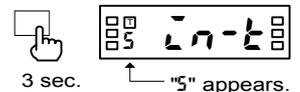

- “5” will appear on the level indicator, indicating the product has entered the initial setting level.

- B.** Press the key several times until parameter “ $\bar{L}nP$ ” appears on the main indicator.

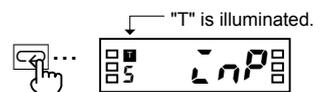

- “T” will be illuminated, indicating teaching of this parameter is possible.
- For the procedure of teaching, refer to the next page.

- C.** Press the key to display the set value of the parameter on the main indicator.



- The current set value of parameter “ $\bar{L}nP$ ” will appear on the indicator.

- D.** Press the key again.



- The set value will start blinking, indicating the product is in the change state.

- E.** Use the and keys to change the set value.

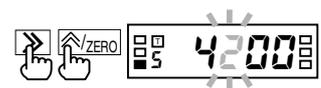

F. Press the  key to go to the next parameter.



- The change is saved and then “dSP” will appear on the main indicator.



G. Press the  key and hold it down for at least one second to return to the operation level.



Teaching

The teaching function allows you to specify the value of parameter “P” without the need for front panel key input.

Procedure

H. Following step **C** (the product is in the monitor state), press the  key.

- “T” will start blinking, indicating the product is in teaching mode.
- Key entry permits the actual process value to be displayed on the main indicator.

I. Press the  key again.

- The actual process value is set as the input value and then the product will return to the monitor state.
- Pressing the  key instead of the  key in teaching mode cancels the teaching mode and the display on the main indicator changes to the next parameter.

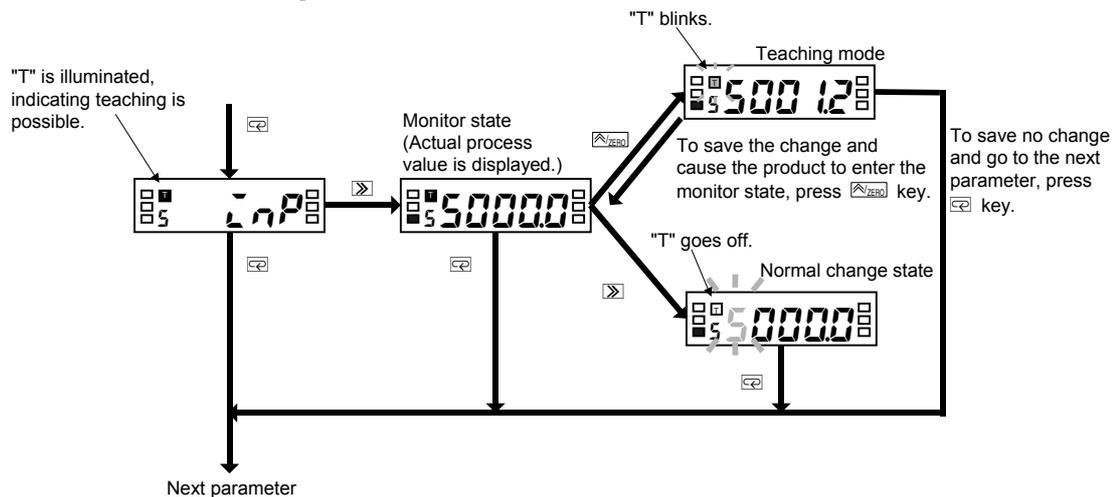

How to Determine Appropriate Scaling Factors

To minimize the scaling operation error, select such a scaling factor that permits the largest possible number of digits to be contained in scaling display values (DSP).

The relationship between the scaling input and display values for input pulse frequency is represented by the following equation.

Scaling display value = α (multiplication factor) \times input frequency (Hz)

Where $\alpha = \text{DSP}/\text{INP}$

α is often an indivisible number such as 5.654866... particularly when the input value is converted to a circumferential velocity. This is because such a conversion involves π .

There are innumerable combinations of scaling input values (INP) and scaling display values (DSP) that result in $\alpha = 5.654866...$ as follows.

INP (Hz)	DSP
1	5.654866...
2	11.30973...
5	28.27433...
10	56.54866...
...	

On the other hand, DSPs that are programmable are limited to 5-digit integers. This means that DSPs must be rounded off to the nearest integers as follows.

INP (Hz)	Programmable DSP
1	00006
2	00011
5	00028
10	00057
...	

Hence, if the input frequency is 1000 Hz, the error between the scaling result and the ideal value increases with the decreasing number of digits contained in the DSP.

INP (Hz)	Programmable DSP	Scaling result (readout)	Ideal value	Error
1	00006	6000	5655	345
2	00011	5500	5655	155
5	00028	5600	5655	55
10	00057	5700	5655	45
...				

Select a combination of the DSP and INP so that the scaling output contains the largest possible number of digits. Doing so minimizes the scaling operation error.

5.13 Specifying the Decimal Point Position

Initial setting level



This parameter allows you to specify the decimal point position of the display value.

Parameter	Set value	Description
dP	0.0000	Readouts are given to four decimal places.
	00.000	Readouts are given to three decimal places.
	000.00	Readouts are given to two decimal places.
	0000.0	Readouts are given to one decimal place.
	00000	Readouts are given as integers.

Procedure

A. When the product is at the operation level, press the key and hold it down for at least three seconds to enter the initial setting level.

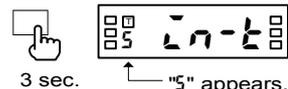

- “5” will appear on the level indicator, indicating the product has entered the initial setting level.

B. Press the key several times until parameter “dP” appears on the main indicator.



C. Press the key to display the set value of the parameter.

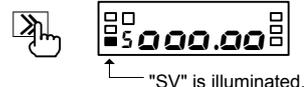

- The current set value for the decimal point position will appear on the main indicator.

D. Press the key again

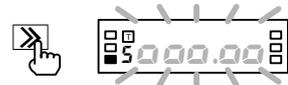

- The set value will start blinking, indicating the product is in the change state.

E. Use the key to change the set value.



F. Press the key to go to the next parameter.



- The change is saved.

G. Press the key and hold it down for at least one second to return to the operation level.



5.14 Selecting the Output Operating Action

Initial setting level

OUT 1L

OUT 2L

These parameters allow you to select the operating action of outputs 1 and 2 respectively.

Parameter	Set value	Description
OUT 1L or OUT 2L	H \bar{L}	Upper limit: Upper-limit action
	L $\bar{0}$	Lower limit: Lower-limit action
OUT 2L	H \bar{L} -L $\bar{0}$	Upper and lower limits: Outside-the-range action

For details, refer to **Section 6.8 Comparative Output**.

Procedure

TIPS

- To specify the OUT set value for the upper or lower-limit action, use parameters *OUT 1L* and *OUT 2L*.
- To specify the OUT set values for the outside-the-range action, use parameters *OUT 1L*, *OUT 2H* and *OUT 2L*.

A. When the product is at the operation level, press the  key and hold it down for at least three seconds to enter the initial setting level.

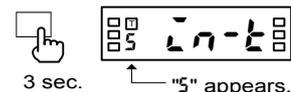

- "5" will appear on the level indicator, indicating the product has entered the initial setting level.

B. Press the  key several times until parameter "OUT 1L" appears on the main indicator.



C. Press the  key to display the set value of the parameter on the main indicator.



- The current set value for the type of comparative output will appear on the main indicator.

D. Press the  key again.



- The set value will start blinking, indicating the product is in the change state.

E. Use the  key to change the set value.



F. Press the  key to display parameter "OUT 2L" on the main indicator.



- The change is saved and then the next parameter "OUT 2L" will appear on the main indicator.

G. Repeat steps **C** to **F** for parameter "OUT 2L".



- Parameter "R000" will appear on the main indicator when you finish setting of parameter "OUT 2L".

H. Press the  key and hold it down for at least one second to return to the operation level.



5.15 Performing Linear Output

Linear output level

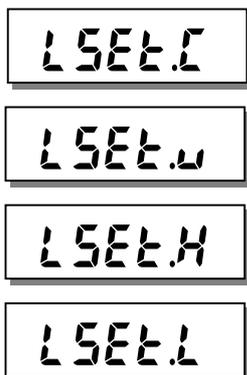

The linear output function outputs currents or voltages proportional to measurement values as they change.

Select the type of linear output. Set the maximum and minimum output measurement values to output the current or voltage for those measurement values.

Parameter	Set value	Description
L5Et.C	0-20	0 to 20 mA
	4-20	4 to 20 mA
L5Et.V	0-5	0 to 5 V
	1-5	1 to 5 V
	0-10	0 to 10 V
L5Et.H	-19999 to 99999	-19999 to 99999
L5Et.L	-19999 to 99999	-19999 to 99999

* When a linear output is mounted, the “linear current type” or “linear voltage type” parameter can be set according to the type of linear output..

Voltage Output

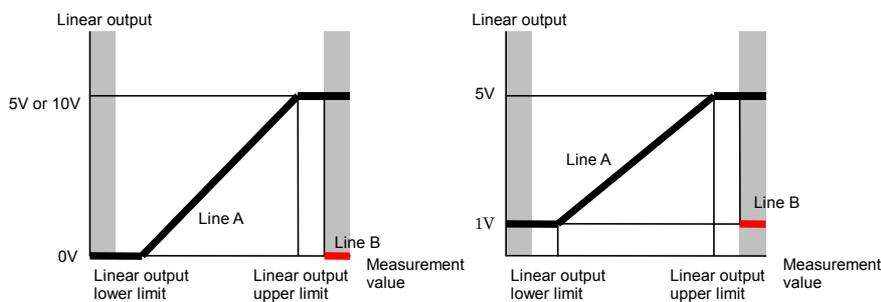

Current Output

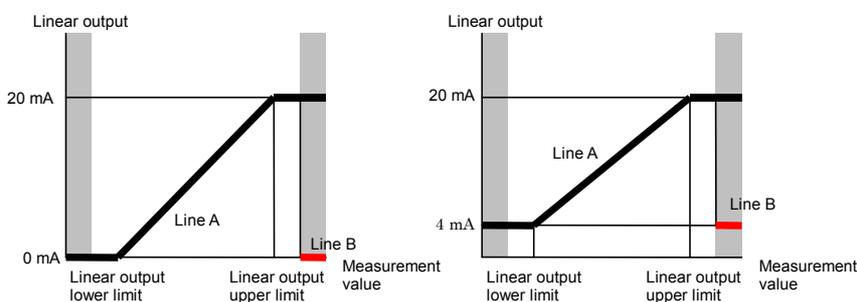

* Areas marked with an asterisk (*) are input error areas. If the “operation at input error” parameter is set to “input error,” then the output would be like Line B. Otherwise, the output would be like Line A.

* If operation stops without performing a measurement, then the minimum value (e.g., 4 mA for the 4 to 20 mA range) is output.

* The value set for the upper limit does not necessarily have to be higher than the value set for the lower limit. The following is an example of reverse scaling.

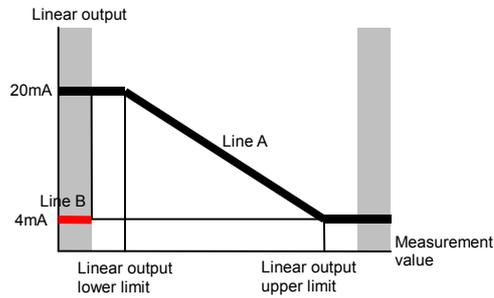

* If the upper and lower limit are set to the same value, then the upper limit will equal the lower limit plus 1 for linear output.

Procedure

A. Press the key for at least 3s in RUN (or operation) level to move to the initial setting level.

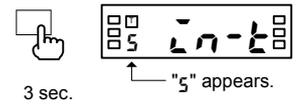

- “5” is displayed on the level display to indicate the initial setting level.

B. Press the key several times to display “L5EEL”.



C. Press the key to display the set value.

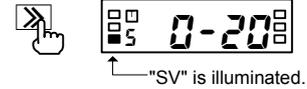

- The set value for linear current type is displayed.

D. Press the key again.



- The setting can be changed when SV display starts to flash.

E. Use the key to change the set value.



F. Press the key to switch to “L5EELH”.



- The set value is registered and then the next parameter “L5EELH”.

G. Press the key to display the set value.

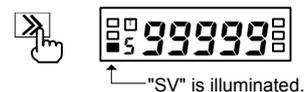

- The set value for linear output upper limit value is displayed.

H. Press the key again.



- The setting can be changed when SV display starts to flash.

OPERATION

I. Use the   [UP] key to change the set value.



J. Press the  key to switch to “LSEt.L”.

- The set value is registered.



K. Repeat steps **G** to **J** to set “LSEt.L”.

- The next parameter is displayed after “LSEt.L” is set.



L. Press the  key for at least 1s to return to RUN (or operation) level.



5.16 Specifying Communication Parameters

Communication setting level



Communication parameters are to be specified at the communication setting level.

Parameter	Set value	Description
U-nō	0 ~ 99	Communication unit No.
bPS	1.2/2.4/4.8 /9.6/19.2	Baud rate (1,200, 2,400, 4,800, 9,600, 19,200 bps)
LEn	7/8	Word length (7 or 8)
Sbc̄t	1/2	Stop bit length (1 or 2)
Prty	nōnE/EuEn /ōdd	Parity bits (None, Even, or Odd)

When connecting multiple products to one host PC, exercise care to avoid assigning the same ID number to more than one product.

Set other communication parameters according to the host PC setting.

Procedure

M. When the product is at the operation level, press the key and hold it down for at least three seconds to enter the initial setting level.

- “5” will appear on the level indicator, indicating the product has entered the initial setting level.

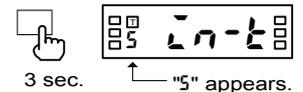

N. Press the key at the initial setting level.

- “E” will appear on the level indicator, indicating the product has entered the communication setting level.

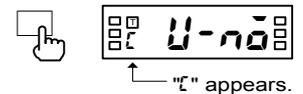

O. Press the key several times until the desired parameter appears on the main indicator.



P. Press the key to display the set value of the desired parameter on the main indicator.

- The current set value will appear on the main indicator.

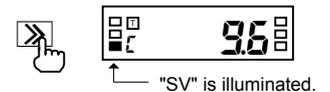

Q. Press the key again.

- The set value will start blinking, indicating the product is in the change state.

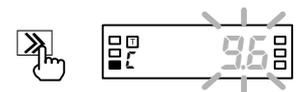

R. Use the key to change the set value.

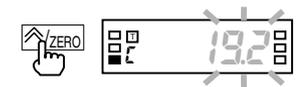

S. Press the key to go to the next parameter.

- The change is saved.



T. Repeat steps **O** to for the remaining communication parameters.



U. Press the key to return to the initial setting level.



V. Press the key and hold it down for at least one second to return to the operation level.

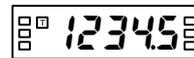

1 sec.

5.17 Clearing All Parameters

Advanced-function setting level



The clear all function can be used to initialize all parameters to factory settings.

Parameter	Set value	Description
Init	OFF	—
	On	Parameters are all initialized.

This function is useful in restarting the setup of the product from the default state.

Procedure

A. When the product is at the operation level, press the key and hold it down for at least three seconds to enter the initial setting level.

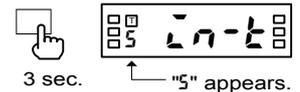

- “5” will appear on the level indicator, indicating the product has entered the initial setting level.

B. Press the key several times until parameter “F0169” is displayed, and then enter password “-0169”.

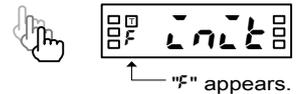

- “F” will appear on the level indicator, indicating the product has entered the advanced-function setting level.
- The first parameter at the advanced-function setting level is “Init”.
- For details on how to move to the advanced-function setting level, refer to **Section 5.2 Moving among Levels**.

C. Press the key to display the set value of parameter “Init” on the main indicator.

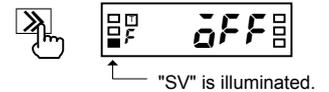

- Set value “OFF” will appear on the main indicator.

D. Press the key again.

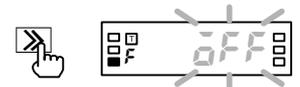

- The set value will start blinking, indicating the product is in the change state.

E. Use the key to change the set value to “On”.



F. Press the key to go to the next parameter.



- All parameters are initialized.
- Parameter “Init” is also set to “OFF”.

G. Press the key and hold it down for at least one second to return to the initial setting level.

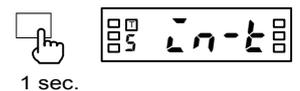

H. Press the key and hold it down for at least one second to return to the operation level.



5.18 Specifying the Number of Measurements for Averaging

Advanced-function setting level

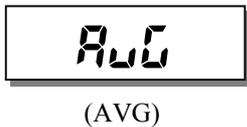

This parameter allows you to specify the number of measurements for averaging.

Parameter	Set value	Description
AVG	OFF	No average processing
	2/4/8	Number of measurements for averaging (2, 4, or 8 times)

For details, refer to **Section 6.4 Average Processing**.

Procedure

A. When the product is at the operation level, press the key and hold it down for at least three seconds to enter the initial setting level..

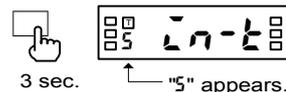

- “5” will appear on the level indicator, indicating the product has entered the initial setting level.

B. Press the key several times until parameter “F” is displayed, and then enter password “-0169”.

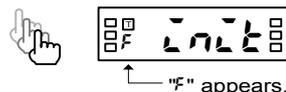

- “F” will appear on the level indicator, indicating the product has entered the advanced-function setting level.
- For details on how to move to the advanced-function setting level, refer to **Section 5.2 Moving among Levels**.

C. Press the key several times until parameter “AVG” appears on the main indicator.



D. Press the key to display the set value of parameter “AVG”.

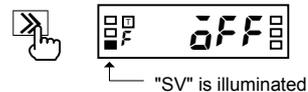

- The current set value for the number of measurements for averaging will appear on the main indicator.

E. Press the key again.



- The set value will start blinking, indicating the product is in the change state.

F. Press the key to change the set value.



G. Press the key to go to the next parameter.



- The change is saved.

H. Press the key and hold it down for at least one second to return to the initial setting level.



I. Press the key and hold it down for at least one second to return to the operation level.



5.19 Specifying the Function of the Event Input

Advanced-function setting level

EVENT

(EVENT)

When the input type has been set to "analog" or "remote", this parameter allows you to specify the function of the event input (terminal ③).

Before specifying the function of the event input, you must set the input type to "analog" or "remote".

Parameter	Set value	Description
EVENT	HOLD	HOLD: The current process value is held.
	ZERO	ZERO: The current process value is forcedly shifted to zero.

For details, refer to **Section 6.5 Process Value Hold**.

Procedure

A. When the product is at the operation level, press the  key and hold it down for at least three seconds to enter the initial setting level..

- "5" will appear on the level indicator, indicating the product has entered the initial setting level.

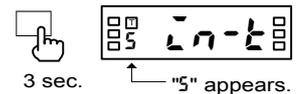

B. Press the  key several times until parameter "F" is displayed, and then enter password "-0169".

- "F" will appear on the level indicator, indicating the product has entered the advanced-function setting level.
- For details on how to move to the advanced-function setting level, refer to **Section 5.2 Moving among Levels**.

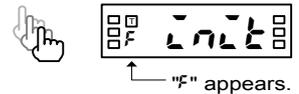

C. Press the  key several times until parameter "EVENT" appears on the main indicator.



D. Press the  key to display the set value of parameter "EVENT" on the main indicator.

- The current set value will appear on the main indicator.



E. Press the  key again.

- The set value will start blinking, indicating the product is in the change state.

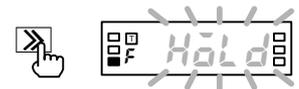

F. Use the  key to change the set value.

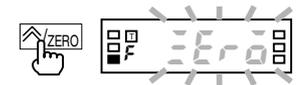

G. Press the  key to go to the next parameter.

- The change is saved.



H. Press the  key and hold it down for at least one second to return to the initial setting level.

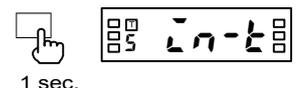

- 1. Press the  key and hold it down for at least one second to return to the operation level.



1 sec.

5.20 Specifying the Hysteresis

Advanced-function setting level



These parameters allow you to specify the hysteresis for each of comparative outputs 1 and 2.

Parameter	Set value	Description
HY5*	0 ~ 9999	0 to 9999: Hysteresis

The setting of the decimal point position parameter at the initial setting level is reflected on the decimal point position of the hysteresis.

For details, refer to **Section 6.9 Hysteresis**.

TIPS

A hysteresis setting of "0" is assumed to be a hysteresis setting of "1".

Procedure

A. When the product is at the operation level, press the key and hold it down for at least three seconds to enter the initial setting level.

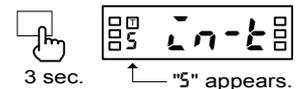

- "5" will appear on the level indicator, indicating the product has entered the initial setting level.

B. Press the key several times until parameter "P n 0 0" is displayed, and then enter password "-0169".

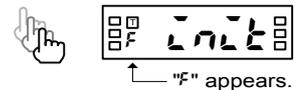

- "F" will appear on the level indicator, indicating the product has entered the advanced-function setting level.
- For details on how to move to the advanced-function setting level, refer to **Section 5.2 Moving among Levels**.

C. Press the key several times until parameter "HY5 1" appears on the main indicator.



D. Press the key to display the set value of parameter "HY5 1" on the main indicator.

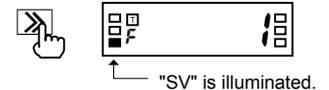

- The current set value will appear on the main indicator.

E. Press the key again.

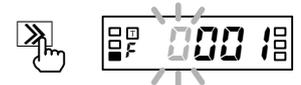

- The set value will start blinking, indicating the product is in the change state.

F. Use the and keys to change the set value.



G. Press the key to go to parameter "HY52".



- The change is saved.

H. Repeat steps **D** to **G** for parameter "HY52".



- The next parameter will appear on the main indicator when you finish setting of parameter "HY52".

I. Press the  key and hold it down for at least one second to return to the initial setting level.

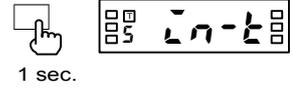

J. Press the  key and hold it down for at least one second to return to the operation level.



5.21 Specifying the Auto-zero Time

Advanced-function setting level

AUTO.Z

(AUTO.Z)

When the input type has been set to "pulse", this parameter allows you to specify the auto-zero time.

Before specifying the auto-zero time, you must set the input type to "pulse".

Parameter	Set value	Description
AUTO.Z	0.0 ~ 19.9	0.0 to 19.9 seconds: Auto-zero time

The auto-zero time is the length of time required for the product to return the readout to zero after pulse input interruption.

Set this parameter to a larger value than the expected time interval of input pulses (interval between input pulses). Failure to do so will result in incorrect measurements.

If the auto-zero time is too long, on the other hand, a long delay in lower-limit action in response to a stop of rotation may result.

In the following application where a pulse is produced per rotation, for example, the input pulse frequency is 0.2 to 100 Hz, which means the time interval of input pulses is 0.01 to 5 seconds.

The auto-zero time should therefore be set to five seconds or longer.

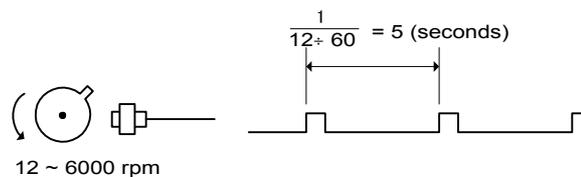

For details, refer to [Section 6.3 Auto-zero/Startup Compensation](#).

Procedure

- A.** When the product is at the operation level, press the key and hold it down for at least three seconds to enter the initial setting level.

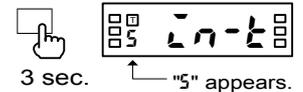

- "5" will appear on the level indicator, indicating the product has entered the initial setting level.

- B.** Press the key several times until parameter "AUTO.Z" is displayed, and then enter password "-0169".

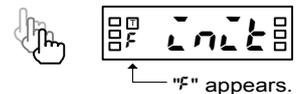

- "F" will appear on the level indicator, indicating the product has entered the advanced-function setting level.
- For details on how to move to the advanced-function setting level, refer to [Section 5.2 Moving among Levels](#).

- C.** Press the key several times until parameter "AUTO.Z" appears on the main indicator.



- D.** Press the key to display the set value of parameter "AUTO.Z" on the main indicator.



- The current set value will appear on the main indicator.

E. Press the  key again.

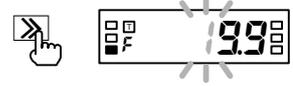

- The set value will start blinking, indicating the product is in the change state.

F. Use the  and  keys to change the set value.

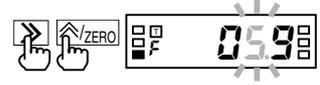

G. Press the  key to go to the next parameter.



- The change is saved and the next parameter will appear on the main indicator.

H. Press the  key and hold it down for at least one second to return to the initial setting level.

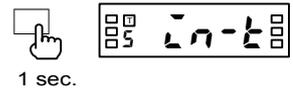

I. Press the  key and hold it down for at least one second to return to the operation level.



5.22 Specifying the Startup Compensation Time

Advanced-function setting level

S-TMR

(S-TMR)

When the input type has been set to "pulse", this parameter allows you to specify the startup compensation time.

Before specifying the startup compensation time, you must set the input type to "pulse".

Parameter	Set value	Description
S-TMR	0.0 ~ 99.9	0.0 to 99.9 seconds: Startup compensation time

The startup compensation time is a delay between power-on of the product and the start of measurement. This function is useful in preventing output from being produced until a rotator reaches a prescribed speed.

For details, refer to **Section 6.3 Auto-zero/Startup Compensation**.

Procedure

A. When the product is at the operation level, press the  key and hold it down for at least three seconds to enter the initial setting level.

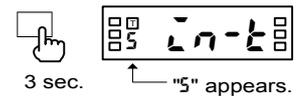

- "5" will appear on the level indicator, indicating the product has entered the initial setting level.

B. Press the  key several times until parameter "F0169" is displayed, and then enter password "-0169".

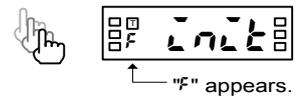

- "F" will appear on the level indicator, indicating the product has entered the advanced-function setting level.
- For details on how to move to the advanced-function setting level, refer to **Section 5.2 Moving among Levels**.

C. Press the  key several times until parameter "S-TMR" appears on the main indicator.



D. Press the  key to display the set value of parameter "S-TMR" on the main indicator.

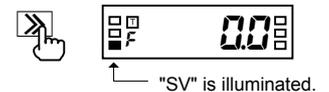

- The current set value of the startup compensation timer will appear on the main indicator.

E. Press the  key again.



- The set value will start blinking, indicating the product is in the change state.

F. Use the  and  keys to change the set value.



G. Press the  key to go to the next parameter.



- The change is saved.

H. Press the  key and hold it down for at least one second to return to the initial setting level.

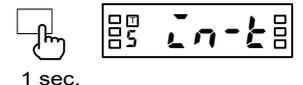

- 1. Press the  key and hold it down for at least one second to return to the operation level.



1 sec.



5.23 Changing the Display Color

Advanced-function setting level



This parameter allows you to change the display color of the main indicator.

Parameter	Set value	Description
CōLōr	Grn-r	Green – red: The display color is normally green, and changes to red at comparative output ON.
	Grn	Green: The display color is always green.
	rEd-G	Red – green: The display color is normally red, and changes to green at comparative output ON.
	rEd	Red: The display color is always red.

For details, refer to **Section 6.10 Display Color Change**.

Procedure

- A.** When the product is at the operation level, press the key and hold it down for at least three seconds to enter the initial setting level.

 - “5” will appear on the level indicator, indicating the product has entered the initial setting level.
- B.** Press the key several times until parameter “F” is displayed, and then enter password “-0169”.

 - “F” will appear on the level indicator, indicating the product has entered the advanced-function setting level.
 - For details on how to move to the advanced-function setting level, refer to **Section 5.2 Moving among Levels**.
- C.** Press the key several times until parameter “CōLōr” appears on the main indicator.
- D.** Press the key to display the set value of parameter “CōLōr” on the main indicator.

 - The current set value of the display color will appear on the main indicator.
- E.** Press the key again.

 - The set value will start blinking, indicating the product is in the change state.
- F.** Use the key to change the set value.
- G.** Press the key to go to the next parameter.

 - The change is saved.
- H.** Press the key and hold it down for at least one second to return to the initial setting level.

- 1. Press the  key and hold it down for at least one second to return to the operation level.



1 sec.



5.24 Changing the Display Auto-return Time

Advanced-function setting level



TIPS

If the display auto-return function is activated in the middle of parameter setting, the product saves the current value of the parameter and then returns to the current value display mode.

This parameter allows you to change the display auto-return time.

Parameter	Set value	Description
rEt	0	0 second: Display auto-return is not available.
	1 ~ 99	1 to 99 seconds: Display auto-return time

If no key is operated for a prescribed time, the product returns to the current value display mode at the operation level.

This prescribed time is called the display auto-return time.

Procedure

A. When the product is at the operation level, press the key and hold it down for at least three seconds to enter the initial setting level.

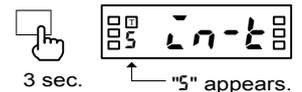

- “5” will appear on the level indicator, indicating the product has entered the initial setting level.

B. Press the key several times until parameter “Pn0u” is displayed, and then enter password “-0169”.

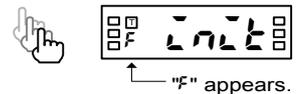

- “F” will appear on the level indicator, indicating the product has entered the advanced-function setting level.
- For details on how to move to the advanced-function setting level, refer to **Section 5.2 Moving among Levels**.

C. Press the key several times until parameter “rEt” appears on the main indicator.



D. Press the key to display the set value of parameter “rEt” on the main indicator.



- The current set value of the display auto-return time will appear on the main indicator.

E. Press the key again.



- The set value will start blinking, indicating the product is in the change state.

F. Use the and keys to change the set value.



G. Press the key to go to the next parameter.



- The change is saved.

H. Press the key and hold it down for at least one second to return to the initial setting level.



- 1. Press the  key and hold it down for at least one second to return to the operation level.



1 sec.

5.25 Changing the Move-to-Protect-Level Time

Advanced-function setting level



This parameter allows you to change the move-to-protect-level time.

Parameter	Set value	Description
PrLt	0 ~ 19	0 to 19 seconds: Move-to-protect-level time

If you press the + keys simultaneously and hold them down for a prescribed time (default: 5 seconds), the product enters the protect level. This prescribed time is called the move-to-protect-level time.

Depending on the setting of the parameter, the product moves from the operation level to the protect levels as follows.

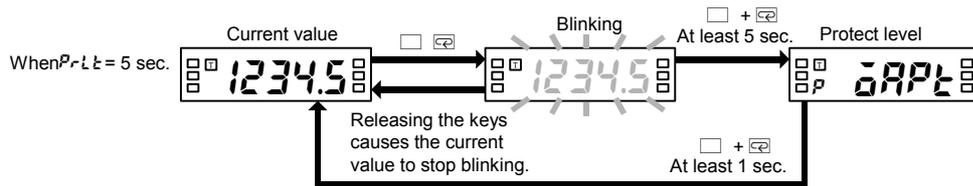

TIPS

A move-to-protect-level time setting of "0" is assumed to be a setting of "1".

Procedure

A. When the product is at the operation level, press the key and hold it down for at least three seconds to enter the initial setting level.

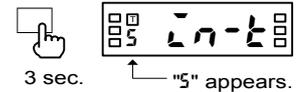

- "5" will appear on the level indicator, indicating the product has entered the initial setting level.

B. Press the key several times until parameter "PrLt" is displayed, and then enter password "-0169".

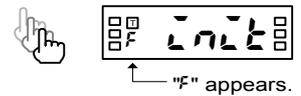

- "F" will appear on the level indicator, indicating the product has entered the advanced-function setting level.
- For details on how to move to the advanced-function setting level, refer to **Section 5.2 Moving among Levels**.

C. Press the key several times until parameter "PrLt" appears on the main indicator.



D. Press the key to display the set value of parameter "PrLt" on the main indicator.

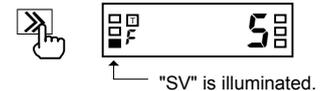

- The current set value of the move-to-protect-level time will appear on the main indicator.

E. Press the key again.



- The set value will start blinking, indicating the product is in the change state.

F. Use the and keys to change the set value.

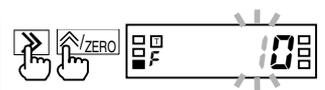

OPERATION

G. Press the  key to go to the next parameter.



- The change is saved.

H. Press the  key and hold it down for at least one second to return to the initial setting level.



1 sec.

I. Press the  key and hold it down for at least one second to return to the operation level.



1 sec.

5.26 Changing the Send Waiting Time

Advanced-function setting level

5d4t
(SDWT)

This parameter allows you to change the send waiting time.

Parameter	Set value	Description
5d4t	0 ~ 99	0 to 99 milliseconds: Send waiting time

The send waiting time is the time between reception of a command frame from the host PC and return of a response frame to the host PC.

To optimize the responsiveness, you should set the send waiting time somewhat longer than the processing time that is required for the host PC to be ready for reception of a response frame after it sends a command frame.

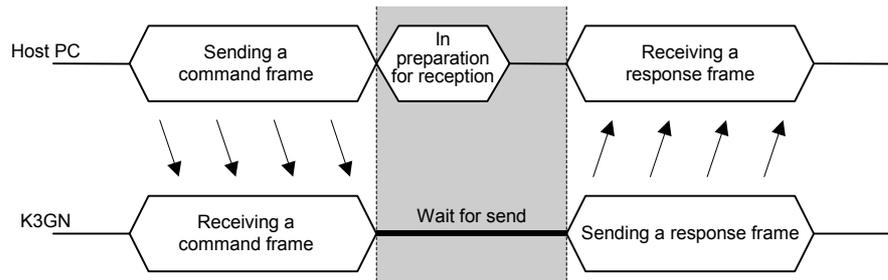

Procedure

A. When the product is at the operation level, press the  key and hold it down for at least three seconds to enter the initial setting level.

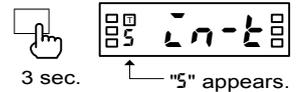

- “5” will appear on the level indicator, indicating the product has entered the initial setting level.

B. Press the  key several times until parameter “F” is displayed, and then enter password “-0169”.

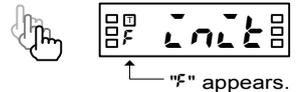

- “F” will appear on the level indicator, indicating the product has entered the advanced-function setting level.
- For details on how to move to the advanced-function setting level, refer to **Section 5.2 Moving among Levels**.

C. Press the  key several times until parameter “5d4t” appears on the main indicator.



D. Press the  key to display the set value of parameter “5d4t” on the main indicator.



- The current set value of the send waiting time will appear on the main indicator.

E. Press the  key again.



- The set value will start blinking, indicating the product is in the change state.

F. Use the  and  keys to change the set value.



G. Press the  key to go to the next parameter.



- The change is saved.

H. Press the  key and hold it down for at least one second to return to the initial setting level.



1 sec.

I. Press the  key and hold it down for at least one second to return to the operation level.



1 sec.

CHAPTER

6

FUNCTION DESCRIPTION

This chapter describes available functions of the product.

6.1	Measurement	84
	Analog Input Signal/Pulse Input Signal/ Digital Data from PLC/PC	
6.2	Scaling	86
6.3	Auto-zero/Startup Compensation	88
	Auto-zero/Startup Compensation	
6.4	Average Processing	89
6.5	Event Input/Pulse Input	90
6.6	Process Value Hold	91
6.7	Forced-zero	92
6.8	Comparative Output	93
6.9	Hysteresis	94
6.10	Display Color Change	95

6.1 Measurement

■ Analog Input Signal

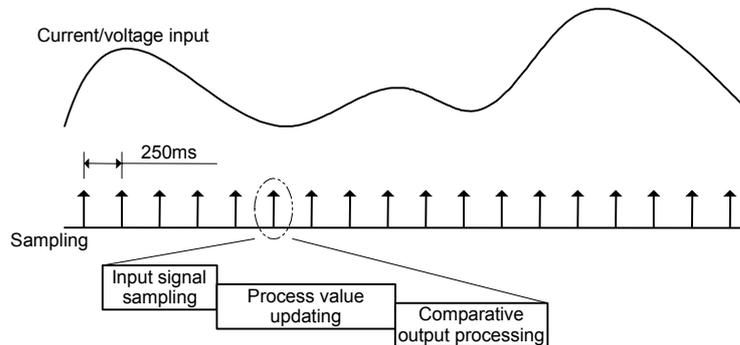

- Input signals are sampled in synchronization with internal timings generated at intervals of 250 ms.
- The input signal is scaled and the process value is updated according to the scaling result. The updated process value is displayed on the main indicator.
- Comparative output is provided based on the process value.
- The process value and comparative output are updated per sampling.

■ Pulse Input Signal

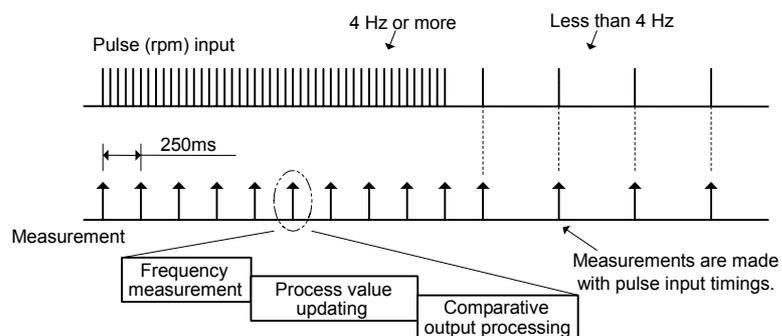

- When the input pulse frequency is 4 Hz or more, it is measured in synchronization with internal timings generated at intervals of 250 ms.
- The input pulse frequency is scaled and the process value is updated according to the scaling result. The updated process value is displayed on the main indicator.
- Comparative output is provided based on the process value.
- The process value and comparative output are updated at intervals of 250 ms.
- When the input pulse frequency is less than 4 Hz, it is measured with pulse input timings; the intervals at which the process value and comparative output are updated lengthen in accordance with the decreasing input pulse frequency.

■ Digital Data from PLC/PC

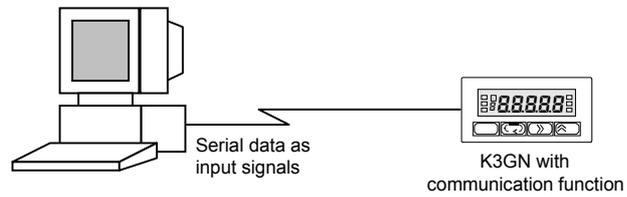

When the product is used as a remote indicator, the host PC not only provides logging of measured data and remote control to the product but also acts as input equipment for the product. The product performs measurement, scaling and comparative output processing.

The product measures serial data as follows.

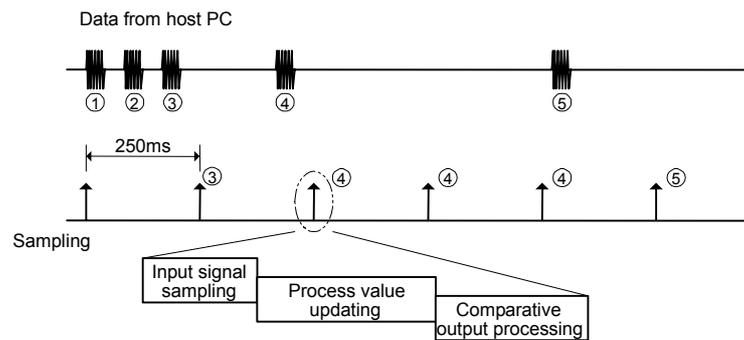

- Data from the host PC is stored with timings of data transmission. When new data is received, old data is replaced with the new one.
- Stored data is fetched as input values in synchronization with internal timings generated at intervals of 250 ms, irrespective of timing signals received from the host PC.
- The input value is scaled and the process value is updated according to the scaling result. The updated process value is displayed on the main indicator.
- Comparative output is provided based on the process value.
- The process value and comparative output are updated with internal timings generated at intervals of 250 ms.

6.2 Scaling

Scaling is to convert sampled input values to process values in sequence using a predetermined scaling formula.

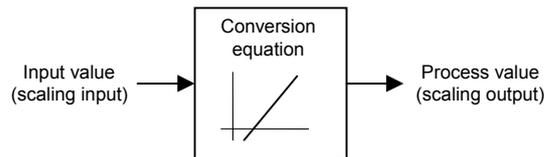

Scaling allows conversion of input values to process values in easy-to-understand notation.

Scaling Formula for Analog Input and Digital Data

The scaling formula for analog input and digital data is as follows.

$$dsp = \frac{DSP2 - DSP1}{INP2 - INP1} inp + \frac{INP1 \cdot DSP2 - INP2 \cdot DSP1}{INP2 - INP1}$$

Where;

INP1: Input value

DSP1: Process value corresponding to input value INP1

INP2: Input value

DSP2: Process value corresponding to input value INP2

inp: Input value sampled

dsp: Process value corresponding to inp

Enter INP1, DSP1, INP2 and DSP2 to specify the scaling factor.

This way of specifying the scaling factor permits flexible scaling; inverse scaling where the process value decreases with the increasing input value is also possible.

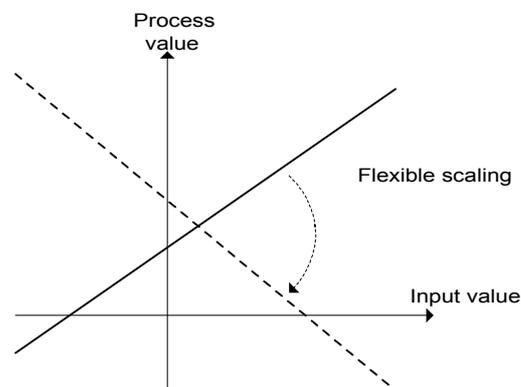

For details on how to specify the scaling factor, refer to **Section 5.11 Specifying the Scaling Factor for Analog Input/Digital Data Display**.

Scaling Formula for Pulse Input

The scaling formula for pulse input is as follows.

$$dsp = \frac{DSP}{INP} inp$$

Where;

INP: Input pulse frequency (Hz)

DSP: Process value corresponding to input pulse frequency INP

inp: Input pulse frequency sampled (Hz)

dsp: Process value corresponding to inp

Enter INP and DSP to specify the scaling factor.

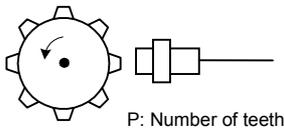
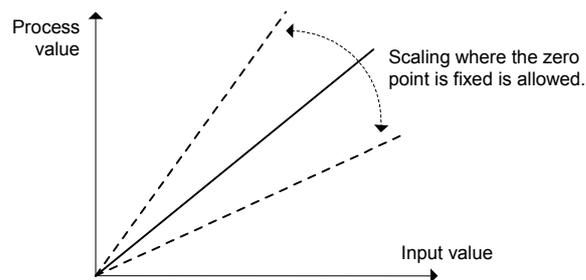

Conversion of the input pulse frequency to the rotational speed involves the following scaling formula.

$$dsp(\text{rpm}) = \frac{60}{P} inp$$

Where;

P: Number of pulses per rotation

inp: Input pulse frequency (Hz)

dsp: Rotational speed (rpm)

TIPS
Unit conversion
rps = rpm/60

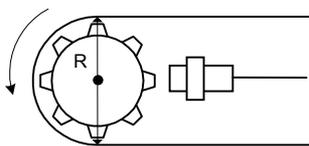

Conversion of the input pulse frequency to the circumferential speed involves the following scaling formula.

$$dsp(\text{m/min}) = \pi \cdot R \cdot \frac{60}{P} inp$$

Where;

π : Circular constant

P: Number of pulses per rotation

R: Diameter of rotator (m)

inp: Input pulse frequency (Hz)

dsp: Circumferential speed (m/min)

TIPS
Unit conversion
m/s = (m/min)/60
mm/s = {(m/min)×1000}/60

6.3 Auto-zero/Startup Compensation

■ Auto-zero

The product has an input-pulse frequency range of 0.05 to 30 Hz or 0.1 to 5 kHz, and hence the maximum interval between pulses is 20 seconds.

This means that the product may provide a lower-limit action signal as late as a maximum of 20 seconds after receiving the last pulse, which results in a poor responsiveness for the lower-limit action.

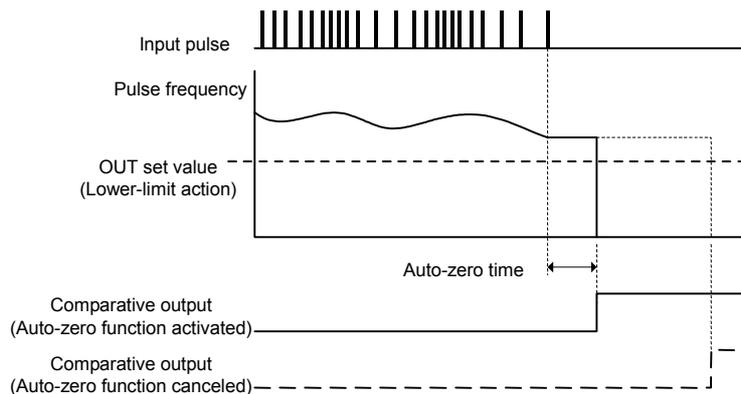

To eliminate such a situation, the product has an **auto-zero** function that shifts the input pulse frequency to zero forcedly when no pulse is received for a predetermined time.

This function improves the product responsiveness for the lower-limit action.

The time between reception of the last pulse and zero-shifting of the input pulse frequency is called the auto-zero time. The auto-zero time can be specified using the “auto-zero time” parameter.

Specify the auto-zero time somewhat longer than the expected longest interval between input pulses.

■ Startup Compensation

The product has a **startup compensation timer** that prevents measurement for a predetermined time after power-on.

This function is useful in keeping the product in wait state until a rotator reaches the steady-state speed.

The time between power-on the product and the start of measurement can be specified using the “startup compensation time” parameter.

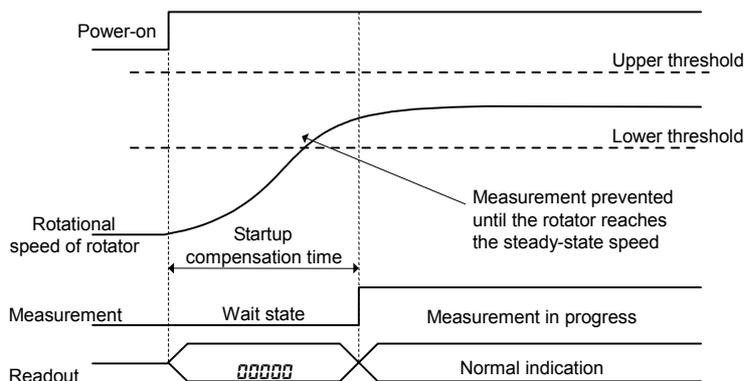

6.4 Average Processing

This function averages a specified number of measurements. It is useful for preventing readouts from fluctuating due to unstable input.

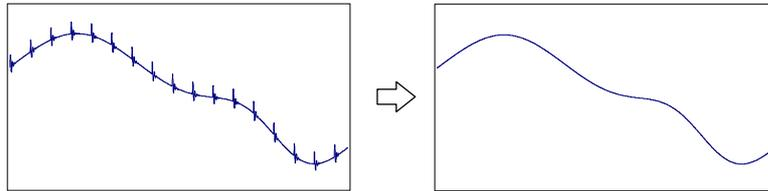

The average processing of the product provides a simple average (an arithmetic mean).

The number of measurements for averaging that can be specified is as follows.

- No average processing (the number of measurements for averaging: 1)
- 2
- 4
- 8

The number of measurements for averaging is the number of times the process value is updated as described in **Section 6.1**.

The following shows the relationship between the number of measurements for averaging and the interval at which the process value and comparative output are updated.

● Analog signal input/Digital data from PC/PLC

Number of measurements for averaging	Update interval
No average processing	250 ms
2	500 ms
4	1 second
8	2 seconds

● Pulse frequency

Number of measurements for averaging	Update interval	
	Input pulse frequency ≥ 4 Hz	Input pulse frequency < 4 Hz
No average processing	250 ms	Every input pulse
2	500 ms	Every 2 input pulses
4	1 second	Every 4 input pulses
8	2 seconds	Every 8 input pulses

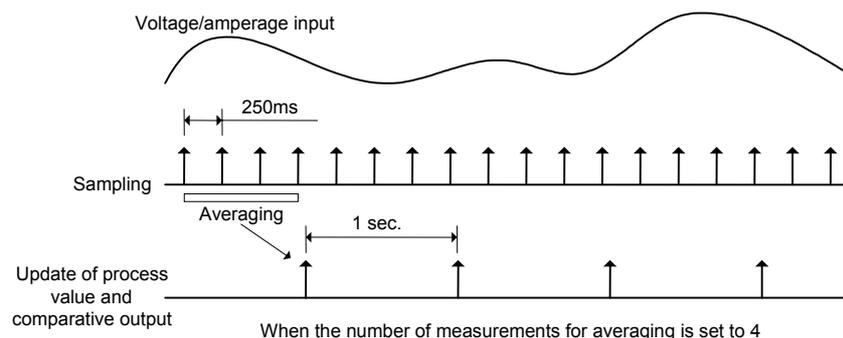

6.5 Event Input/Pulse Input

Terminal ③ acts as the **event input** terminal when the input type is set to "analog" or "remote" and as the **pulse input** terminal when the input type is set to "pulse". The event input terminal can be assigned the task of "process value hold" or "forced-zero". This assignment depends on setting of the "event input" parameter at the advanced-function setting level.

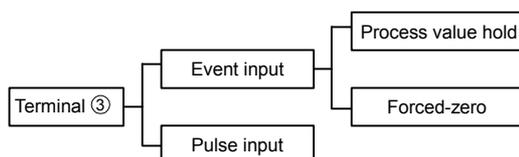

Minimum Pulse Width

The minimum pulse width of ON/OFF signals recognizable to the product varies between the event and pulse inputs.

● For event input

When terminal ③ is used for event input, chattering noise is removed from input signals and therefore devices of contact output type can be connected to the terminal.

The chattering noise removal processing suppresses signal fluctuations that occur within 30 to 40 ms after the input signal turns on or off.

Both ON and OFF pulses must therefore have at least 40 ms in width.

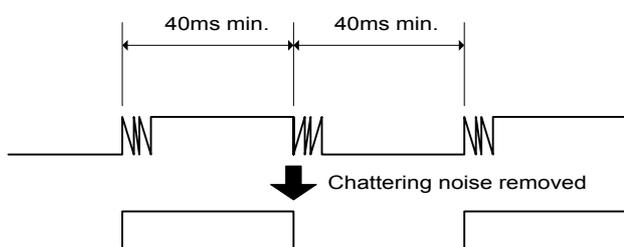

● For pulse input

When terminal ③ is used for pulse input, devices of low-speed contact output type or high-speed transistor output type can be connected to the terminal depending on parameter setting.

When using a device of low-speed contact output type, set the input pulse frequency to "30 Hz". In this case, chattering noise is removed and accordingly both ON and OFF pulses must have at least 15 ms in width.

When using a device of high-speed transistor output type, set the input pulse frequency to "5 kHz". In this case, both ON and OFF pulses must have at least 90 μ s in width.

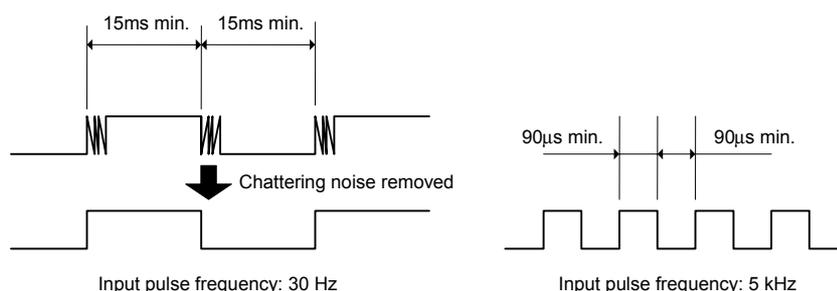

6.6 Process Value Hold

TIPS

The “process value hold” function is available only when the input type is set to “analog” or “remote” and terminal ③ is assigned the task of “process value hold”.

This function detects the process value at the instant when the event input turns on, and holds the value as long as the event input is on.

It can be used to hold the process value detected when a failure occurs.

“Process value hold” takes place via the event input terminal.

The following illustrates the “process value hold” operation.

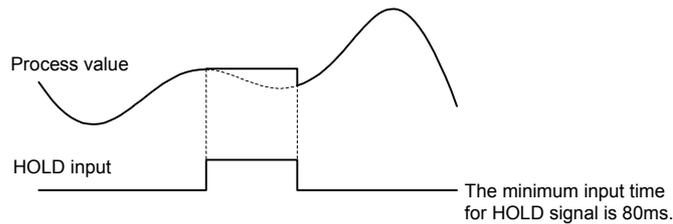

- When the event input (HOLD) turns on, the process value is detected and held.
- If the input value changes, the process value continues to be held as long as the event input is on.
- When the event input (HOLD) turns off, the “process value hold” function is canceled and the display returns to the current value.

6.7 Forced-zero

Note

The forced-zero function is not available when the input type is set to "pulse". Key entry for the forced-zero operation is also ignored.

TIPS

The forced-zero function is available via the event input terminal only when the input type is set to "analog" or "remote" and terminal ③ is assigned the task of "forced-zero execution".

This feature shifts a process value to zero, and can be used to evaluate and display the deviation of a process value from a reference value.

The forced-zero function can be activated by using the  key on the front panel, via the event input terminal, or communications

The following illustrates the forced-zero and forced-zero cancel operation.

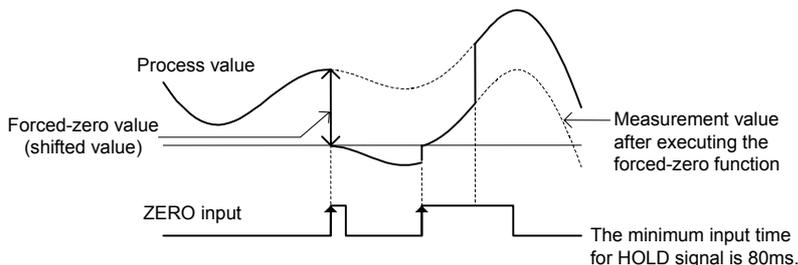

- When ZERO input turns on, the current process value is shifted to zero forcibly.
- Thereafter, measurements are made relative to the zero point.
- When ZERO input turns on while the forced-zero function has been activated, the current process value is further shifted to zero.
- When ZERO input is on for one second, the forced-zero operation is canceled.

Because the forced-zero and forced-zero cancel operation using the  key is stored in EEPROM, the forced-zero state is alive even if the power is turned off and on again.

In contrast, the forced-zero and forced-zero cancel operation via event input terminal is not stored in EEPROM.

If the forced-zero operation is executed via the event input terminal after it is activated by key entry, the forced-zero operation via the event input terminal takes effect.

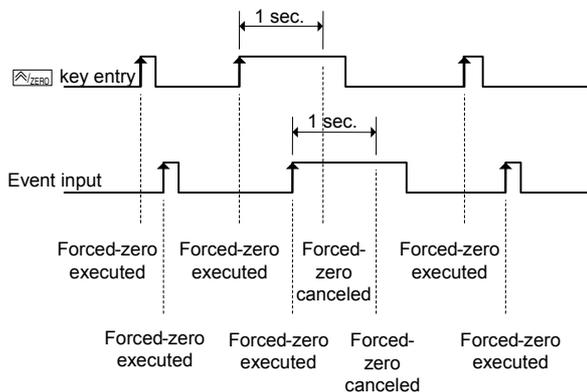

The forced-zero cancel operation is ignored if the forced-zero function has already been deactivated.

6.8 Comparative Output

Comparative outputs 1 and 2 can be produced as three types of action signals: upper-limit action signal, lower-limit action signal, and outside-the-range action signal.

Upper-limit Action

Comparative output turns on when the process value reaches the OUT set value.

Comparative output turns off when the process value decreases to (OUT set value - hysteresis).

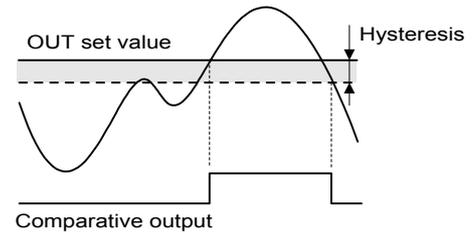

Lower-limit Action

Comparative output turns on when the process value decreases to the OUT set value.

Comparative output turns off when the process value reaches (OUT set value + hysteresis).

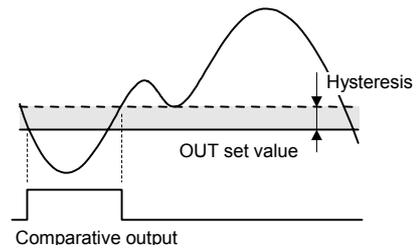

Outside-the-range Action

Comparative output turns on when the process value reaches the OUT upper-limit value or decreases to the OUT lower-limit value.

Comparative output turns off when the process value falls inside the range of (OUT upper-limit value - hysteresis) to (OUT lower-limit value + hysteresis).

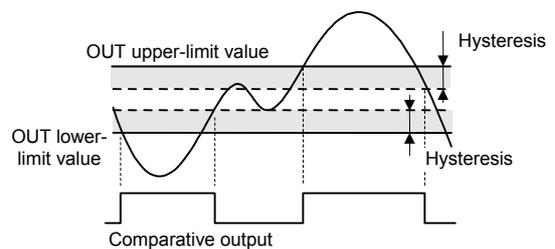

Combinations of comparative outputs 1 and 2 offer the possibility of producing a wide variety of actions including upper-limit + another upper-limit actions, lower-limit + another lower-limit actions, and two-level outside-the-range actions.

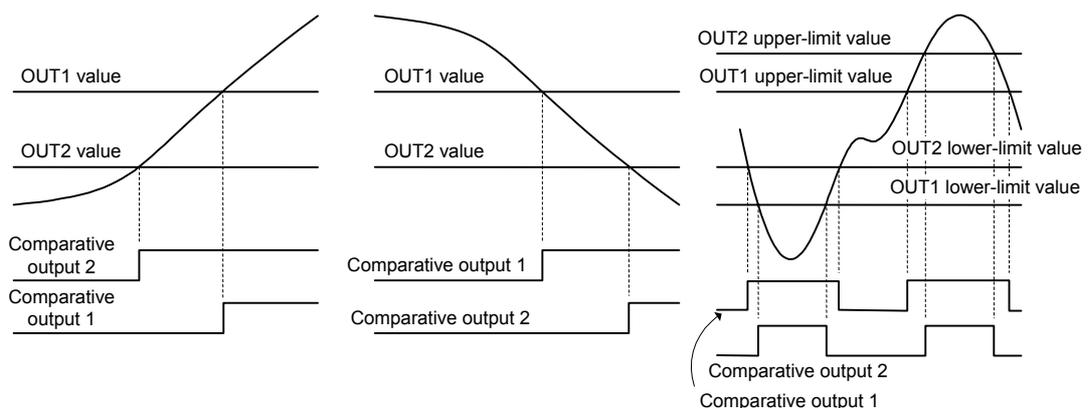

6.9 Hysteresis

In this manual, **hysteresis** refers to a range that is provided above or below an OUT set value in order to avoid comparative output from turning off unless the process value falls outside the range, once the comparative output has turned on at the OUT set value.

Specifying the hysteresis suppresses chattering of comparative output caused by fluctuations of the process value in the vicinity of the OUT set value.

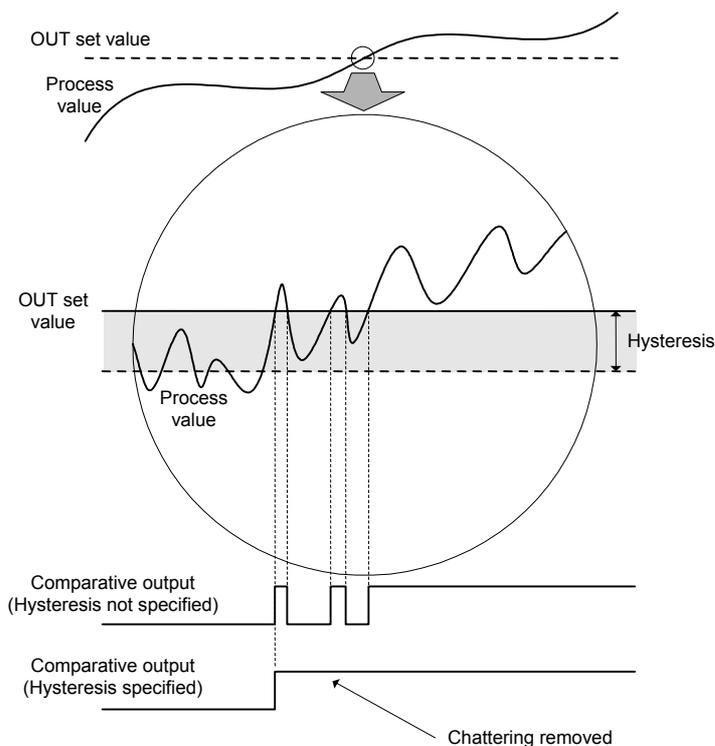

Comparative output ON/OFF conditions are as follows.

- Upper-limit action
 - ON: Process value \geq OUT set value
 - OFF: Process value \leq OUT set value – Hysteresis
- Lower-limit action
 - ON: Process value \leq OUT set value
 - OFF: Process value \geq OUT set value + Hysteresis

Set the hysteresis to a value ranging from 1 to 9999 at the advanced-function setting level.

For the procedure for hysteresis setting, refer to **Section 5.19 Specifying the Hysteresis**.

6.10 Display Color Change

The display color of the main indicator can be changed.

This feature can be used to vary the display color of the gang-mounted products depending on their importance or to give greater prominence to indications on the main indicator of certain products in an emergency.

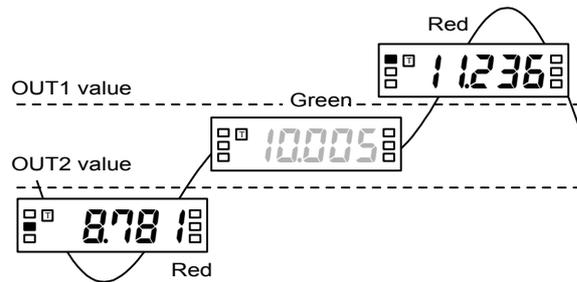

Display color change from green to red

Four display color change options are available.

Green to red: The display color of the main indicator is green when both of comparative outputs 1 and 2 is off, and changes to red when either of the comparative outputs turns on.

Always green: The display color is always green.

Always red: The display color is always red.

Red to green: The display color is red when both of comparative outputs 1 and 2 is off, and changes to green when either of the comparative outputs turns on.

Select one among these options at the advanced-function setting level.

For the procedure for programming of display colors, refer to **Section 5.22 Changing the Display Color**.

CHAPTER

7

COMMUNICATIONS

This chapter describes commands and responses conforming to the CompoWay/F serial communication format and how to control the product by the host PC via communications.

7.1	Communication Protocols	98
	CompoWay/F Communication Protocol/ Communication Specification/Transmission Procedure	
7.2	Data Format Structure	99
	Command Frame/Response Frame	
7.3	Structure of Command/Response Text	101
7.4	Variable Area	102
7.5	Read from Variable Area	103
7.6	Write to Variable Area	104
7.7	Operation Instructions	105
7.8	Setting Areas	106
7.9	Commands and Responses	107
	Read Process Value/Read Status/Read Remote Input Value/ Read OUT Set Value/Write OUT Set Value/Read Parameter/ Write Protect Level Parameter/ Write Parameter (Setting Area 1)/Communication Writing/ Forced-zero Execution/Cancel/ Software Reset/Move to Setting Area 1/ Move to Protect Level/Read Controller Attribute / Read Controller Status/Read Version/Echoback Test	
7.10	Variable Area Map	115
7.11	Communications Control Flow	118
	Communication Reading/ Communication Writing (Setting Area 0)/ Protect Level Parameter Writing/ Parameter Writing (Setting Area 1)/Operation Instruction	
7.12	Programming Example	123
	N88 BASIC/Protocol Macro	

7.1 Communication Protocols

■ CompoWay/F Communication Protocol

TIPS

The program for communications is created on the host PC, and K3GN's parameters are monitored or set from the host PC. In this manual, consequently, an explanation for communications is given from the standpoint of the host PC.

CompoWay/F is an OMRON's standard communication format for general serial communications. It uses a standard frame format as well as FINS commands that have been proven in data exchange between OMRON's programmable logic controllers. The CompoWay/F format facilitates serial communications between components or a PC and components.

FINS (Factory Interface Network Service)

FINS is a protocol for message communications between controllers in OMRON FA networks.

■ Communication Specification

Transmission line connection:	Multipoint
Communications method:	Two-wire, half-duplex
Synchronization method:	Start-stop synchronization
Baud rate:	1,200, 2,400, 4,800, 9,600, or 19,200 bps
Communication code:	ASCII
Word length:	7 or 8 bits
Stop bit length:	1 or 2 bits
Parity check:	Vertical parity - Non, Odd, or Even BCC (block check character) Start-stop synchronization data composition
Flow control:	Non
Interface:	RS-485
Retry function:	Non

■ Transmission Procedure

Communications between the product and the host PC are implemented on a frame-by-frame basis.

When the host PC sends a command frame to the product, the product returns to the host PC a response frame that corresponds to the command frame.

Command and response frames are transmitted as follows.

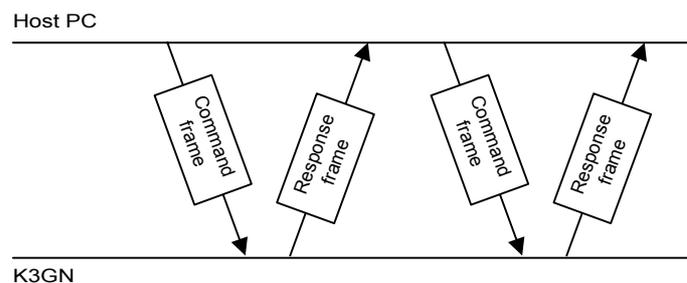

7.2 Data Format Structure

Combinations conforming to the CompoWay/F serial communication format involve transmission of blocks of data that are called **frames**. Those sent from the host PC are command frames and those from the product are response frames.

The structure of these frames is shown below.

In the following frame description, suffix H added to a numeric value, as in 02H, means the value is a hexadecimal number. And double quotation marks in which an alphanumeric value is enclosed, as in "00", mean that the value is an ASCII character set.

The number underneath each delimiter in a frame indicates the number of bytes.

■ Command Frame

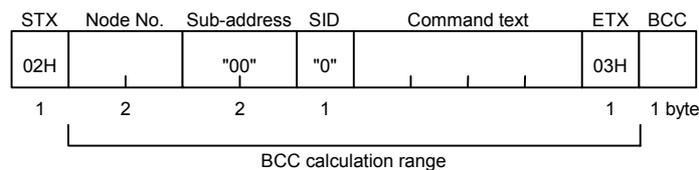

STX	Code indicating the start of a command frame (02H). Be sure to place this code in the first byte of a command frame.
Node No	Node ID specifying the destination of a command frame. Set this No. to the "unit No." of the product. If you want to broadcast a command, set this No. to "XX". Note that, in this case, no response is given from the products.
Sub-address	Not used for K3GN. Always set the sub-address to "00".
SID (Service ID)	Not used for K3GN. Always set the SID to "0".
Command text	Command text
ETX	Code indicating the end of text (03H)
BCC	Block check character. The result of block check on the BCC calculation range is stored in this field.

TIPS

How to determine BCC: BCC is determined by XOR operation, on a byte-by-byte basis, of the values within the range from the Node No. field to the ETX field. The result (36H in the example shown right) is placed in the BCC field.

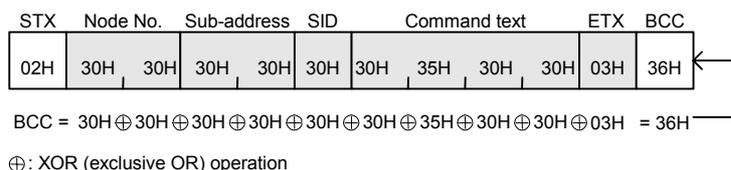

■ Response Frame

STX	Node No.	Sub-address	End code	Response text	ETX	BCC
02H		"00"			03H	
1	2	2	2		1	1 byte

TIPS

The product does not respond to such a command frame that does not end in ETX and BCC characters.

STX	Code indicating the start of a response frame (02H). Be sure to place this code in the first byte of a response frame.
Node No	The Node No. is set to the value that was specified in the corresponding command frame. The unit No. of the product that returns the response is set in this field.
Sub-address	Not used for K3GN. This field is always set to "00".
End code	This field contains the result of execution of the corresponding command frame.
Response text	Response text
ETX	Code indicating the end of text (03H)
BCC	Block check character. The result of block check on the BCC calculation range is stored in this field.

● End code

End code	Code name	Description
"11"	Framing error	A framing error (the stop bits represented 0) occurred in one of the characters received.
"10"	Parity error	The sum of the bits of "1" in the received data does not match the specified number.
"12"	Overrun error	An attempt was made to transfer new data when the buffer was full.
"18"	Frame length error	The size of the received frame exceeded the specified number of bytes.
"13"	BCC error	The received BCC was different from the calculated BCC.
"16"	Sub-address error	<ul style="list-style-type: none"> No sub-address, SID, and command text. This error is not covered by the echoback test. The size of the sub-address was less than two characters, and no SID and command text were found.
"14"	Format error	<ul style="list-style-type: none"> The command text contains characters other than "0 thru "9" and "A" thru "F". Echoback Test excepted. (See Echoback Test for details.) No SID and command text. MRC and SRC in the command text were not included in the command text.
"0F"	FINS command error	The specified FINS command could not executed. (The FINS response code may provide a suggestion about the reason of the failure in command execution.)
"00"	Normal completion	The command was successfully executed.

7.3 Structure of Command/Response Text

The command/response text constitutes the main body of a command/response frame.

The structure of the command/response text is as follows.

Command Text

The command text consists of MRC (Main Request Code) and SRC (Sub Request Code) followed by the required data.

Response Text

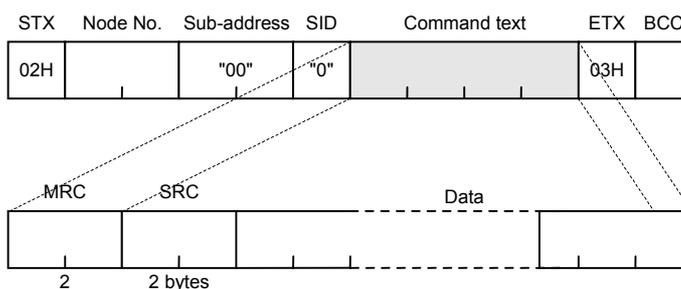

The response text consists of MRC and SRC followed by MRES (Main Response Code) and SRES (Sub Response Code) and the required data.

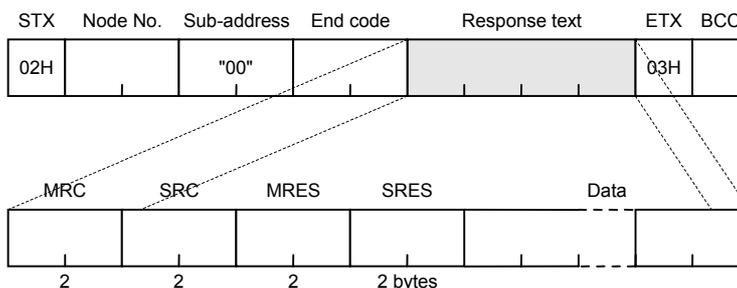

If the product fails to execute a specified command, it generates a response consisting of MRC/SRC and MRES and SRES only.

● List of services

MRC	SRC	Service name	Description
"01"	"01"	Read from variable area	This service reads from the variable area.
"01"	"02"	Write to variable area	This service writes to the variable area.
"05"	"03"	Read controller attribute	This service reads the model No. and the communications buffer size.
"06"	"01"	Read controller status	This service reads the run status of the controller.
"08"	"01"	Echoback test	This service carries out the echoback test.
"30"	"05"	Operation instructions	This service carries out forced-zero (cancel) operation, etc.

7.5 Read from Variable Area

This service reads data from the variable areas.

Command

Command text

MRC	SRC	Variable type	Read start address	Bit position	No. of elements
"01"	"01"			"00"	
2	2	2	4	2	4 bytes

Item	Description
MRC/SRC	Set these items to "01"/"01" ("Read from Variable Area" service).
Variable type	Set this item to one among "C0" thru "C3".
Read start address	Specify the read start address at this field.
Bit position	Not used for K3GN. Always set this item to "00".
No. of elements	Set this item to the quantity of variables that are to be read (up to 10).

Response

Response text

MRC	SRC	Response code (MRES/SRES)	Data to be read
"01"	"01"		
2	2	4	(No. of elements x 8) bytes

Item	Description
MRC/SRC	This field contains the same value ("01"/"01") as specified in the command text.
Response code	This field contains the result of execution of the command.
Data to be read	This field contains the data that is read and to be read.

Response codes

Response code	Code name	Description
"1001"	Command length over	The command is too long.
"1002"	Command length short	The command is too short.
"1101"	Area type error	The specified variable type is invalid.
"1103"	Start address out-of-range error	The specified start address is outside the valid range.
"110B"	Response length over	The No. of elements exceeds 10.
"1100"	Parameter error	The bit position is set to a value other than "00".
"2203"	Operation error	EEPROM error
"0000"	Normal completion	The command was successfully executed.

7.6 Write to Variable Area

This service writes data to the variable area.

Command

Command text

MRC	SRC	Variable type	Write start address	Bit position	No. of elements	Data to be written
"01"	"02"			"00"		
2	2	2	4	2	4 bytes	(No. of elements x 8) bytes

Item	Description
MRC/SRC	Set these items to "01"/"02" ("Write to Variable Area" service).
Area type	Set this item to one among "C1" thru "C3".
Write start address	Specify the write start address at this field.
Bit position	Not used for K3GN. Always set this item to "00".
No. of elements	Set this item to the quantity of variables that are to be written (up to 10).
Data to be written	Place the desired data in this field.

Response

Response text

MRC	SRC	Response code (MRES/SRES)
"01"	"02"	
2	2	4

Item	Description
MRC/SRC	This field contains the same value ("01"/"02") as specified in the command text.
Response code	This field contains the result of execution of the command.

Response codes

Response code	Code name	Description
"1002"	Command length short	The command is too short.
"1101"	Area type error	The specified variable type is invalid.
"1103"	Start address error	The specified start address is outside the valid range.
"1104"	End address error	The specified start address is outside the valid range.
"1003"	Data quantity mismatch error	A mismatch between the No. of elements and the quantity of variables occurs.
"1100"	Parameter error	<ul style="list-style-type: none"> The bit position is set to a value other than "00". The value of data to be written is outside the valid range.
"3003"	Read only error	An attempt is made to write data to an address of variable type C0.
"2203"	Operation error	<ul style="list-style-type: none"> Communication writing is disabled. An attempt is made to write data from setting area 0 to setting area 1. An attempt is made to write a protect level parameter at a level other than protect level. An attempt is made to write data to an address of variable type C3 at the calibration level. An error occurs in EEPROM.
"0000"	Normal completion	The command was successfully executed.

7.7 Operation Instructions

To issue an operation instruction to the product, set the items in the command text as follows.

Command

Command text

MRC	SRC	Instruction code	Related information
"30"	"05"		
2	2	2	2 bytes

Item	Description
MRC/SRC	Set these item to "30"/"05" (Operation Instruction service).
Instruction code	Place an instruction code in this field.
Related information	Place information related to the operation instruction in this field.

Instruction codes

Instruction code	Operation	Related information
"00"	Communication writing	"00": Off (disable) "01": On (enable)
"03"	Forced-forced-zero execution/ Forced-zero cancel	"00": Cancel "01": Execute
"06"	Software reset	"00"
"07"	Move to setting area 1	"00"
"08"	Move to protect level	"00"

Response

Response text

MRC	SRC	Response code (MRES/SRES)
"30"	"05"	
2	2	4 bytes

Item	Description
MRC/SRC	This field contains the same value ("30"/"05") as specified in the command text.
Response code	This field contains the result of execution of the command.

Response codes

Response code	Code name	Description
"1001"	Command length over	The command is too long.
"1002"	Command length short	The command is too short.
"1100"	Parameter error	The instruction code or related information is invalid.
"2203"	Operation error	<ul style="list-style-type: none"> Communication writing is disabled. The specified operation cannot be executed. For details, refer to Section 7.9 Commands and Responses . <ul style="list-style-type: none"> An error occurs in EEPROM.
"0000"	Normal completion	The command was successfully executed.

7.8 Setting Areas

The K3GN series of products can assume two states that are referred to as **setting area 0** and **setting area 1** in this manual.

In setting area 0, the product is carrying out a measurement.

In this state, you can therefore perform such operations that are permitted only during measuring, or that cause no trouble even if a measurement is in progress. These operations include “process value reading”, “parameter writing” and “forced-zero execution”.

On the contrary, this state prohibits such operations that exert an effect on measurement in progress, including “parameter writing at the initial setting level” (parameter reading is always allowed).

In setting area 1, measurement is suspended.

In this state, you can therefore perform such operations that are not allowed in setting area 0. These operations include “parameter writing at the initial setting, communication setting, and advanced-function setting levels”.

At power-on, the product is in setting area 0. To move to setting area 1, use the “move-to-setting area 1” instruction. To return to setting area 0, power the product off and on again, or use the “software reset” instruction.

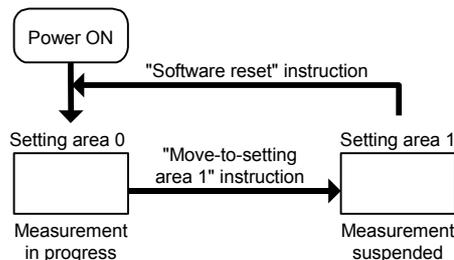

The figure on the right shows the setting areas and the levels contained in each setting area.

A transition to the initial setting level by key operation implies a transition from setting area 0 to setting area 1. This enables the host PC to operate the product in setting area 1.

A transition to setting area 1 by remote control from the host PC causes the level indicator on the front panel to indicate the product is at the initial setting level. To return to the operation level, use the key.

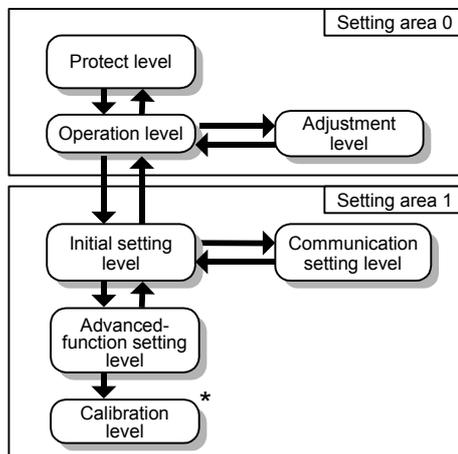

* At the calibration level, the product refuses control from the host PC.

7.9 Commands and Responses

Various commands for application layer are available for implementing the services, such as “variable area read/write” and “operation instructions”, offered by the CompoWay/F communication format.

This section contains description of the available commands for the application layer.

■ Read Process Value

Command		MRC	SRC	Variable type	Address	Bit position	No. of elements
		"01"	"01"	"C0"	"0001"	"00"	"0001"

This command reads the current process value.

Use this command when the product is in setting area 0.

(If the product is in setting area 1 when receiving the command, it returns a response with the “unknown” current value data).

Response		MRC	SRC	Response code	Data
		"01"	"01"	"0000"	Process value

Response code: The code shown above represents normal completion. For details on the response code, refer to **Section 7.5 Read from Variable Area**.

■ Read Status

Command		MRC	SRC	Variable type	Address	Bit position	No. of elements
		"01"	"01"	"C0"	"0002"	"00"	"0001"

This command reads the status of comparative outputs or the like.

Use this command when the product is in setting area 0.

(If the product is in setting area 1 when receiving the command, it returns a response with the “unknown” status data).

Response		MRC	SRC	Response code	Data
		"01"	"01"	"0000"	Status

For details on the status, refer to **Section 7.10 Variable Area Map**.

Response code: The code shown above represents normal completion. For details on the response code, refer to **Section 7.5 Read from Variable Area**.

■ Read Remote Input Value

Command

MRC	SRC	Variable type	Address	Bit position	No. of elements	Data
"01"	"02"	"C2"	"0000"	"00"	"0001"	Remote input value

This command supplies an input value to the product that is used as a digital data display for PLC/PC.

Use this command when the product is in setting area 0.

(If the product is in setting area 1 when receiving the command, no change occurs on the main indicator as measurement is suspended).

Before issuing the command, use an operation instruction to enable “communication writing”.

Response

MRC	SRC	Response code
"01"	"02"	"0000"

Response code: The code shown above represents normal completion. For details on the response code, refer to **Section 7.6 Write to Variable Area**.

■ Read OUT Set Value

Command

MRC	SRC	Variable type	Address	Bit position	No. of elements
"01"	"01"	"C2"		"00"	"0001"

Address	Parameter
"0001"	OUT1 value
"0002"	OUT1 upper-limit value
"0003"	OUT1 lower-limit value
"0004"	OUT2 value
"0005"	OUT2 upper-limit value
"0006"	OUT2 lower-limit value

This command reads an OUT set value.

(Even if the type of the OUT set value is “upper” or “lower”, OUT upper and lower-limit values can be read. Even if the type of the OUT set value is “upper/lower”, an OUT set value can be read).

Response

MRC	SRC	Response code	Data
"01"	"01"	"0000"	Threshold

Response code: The code shown above represents normal completion. For details on the response code, refer to **Section 7.5 Read from Variable Area**.

Write OUT Set Value

MRC	SRC	Address	No. of elements	Data
"01"	"02"	"C2"	"00"	"0001" OUT set value

Address	Parameter
"0001"	OUT1 value
"0002"	OUT1 upper-limit value
"0003"	OUT1 lower-limit value
"0004"	OUT2 value
"0005"	OUT2 upper-limit value
"0006"	OUT2 lower-limit value

This command writes an OUT set value.

It can be used when the product is in either setting area 0 or 1.

(Even if the type of the OUT set value is “upper” or “lower”, OUT upper and lower-limit values can be written. Doing so exerts no effect on comparative output. Likewise, even if the type of the OUT set value is “upper/lower”, an OUT set value can be written).

If you want to write both OUT1 and OUT2 values at a time, use block access to the variable area. For details, refer to the tip shown in **Section 7.10 Variable Area Map**.

Before issuing the command, use an operation instruction to enable “communication writing”.

MRC	SRC	Response code
"01"	"02"	"0000"

Response code: The code shown above represents normal completion. For details on the response code, refer to **Section 7.6 Write to Variable Area**.

Read Parameter

MRC	SRC	Variable type	Address	Bit position	No. of elements
"01"	"01"			"00"	"0001"

Variable type	Address	Parameter
"C1"	"0000" to "0003"	Protect level parameters
"C3"	"0000" to "000B"	Initial setting level parameters
	"000C" to "0010"	Communication setting level parameters
	"0011" to "001D"	Advanced-function setting level parameters

This command reads a parameter.

For details on how to specify the variable type and the address, refer to **Section 7.10 Variable Area Map**.

This command can be used when the product is in either setting area 0 or 1.

(“Analog range”, “input pulse frequency”, “scaling input values 1 and 2”, “scaling display values 1 and 2”, “scaling input value”, and “scaling display value” can be read, irrespective of input type setting).

MRC	SRC	Response code	Data
"01"	"01"	"0000"	Parameter

Response code: The code shown above represents normal completion. For details on the response code, refer to **Section 7.5 Read from Variable Area**.

Write Protect Level Parameter

Command		MRC	SRC	Variable type	Address	Bit position	No. of elements	Data
"01"	"02"	"C1"				"00"	"0001"	Protect level parameter

Address	Parameter
"0000"	Operation/adjustment lockouts
"0001"	Initial setting/communication lockouts
"0002"	Setting change lockout
"0003"	Forced-zero lockout

This command writes a protect level parameter.

Use this command when the product is in setting area 0. If the product is in setting area 1 when receiving the command, it returns an error.

Before issuing the command, use operation instructions to enable “writing” and to enter the protect level.

Response		
MRC	SRC	Response code
"01"	"02"	"0000"

Response code: The code shown above represents normal completion. For details on the response code, refer to **Section 7.6 Write to Variable Area**.

Write Parameter (Setting Area 1)

Command		MRC	SRC	Variable type	Address	Bit position	No. of elements	Data
"01"	"02"	"C3"				"00"	"0001"	Parameter (setting area 1)

Address	Parameter
"0000" to "000B"	Initial setting level parameters
"000C" to "0010"	Communication setting level parameters
"0011" to "001D"	Advanced-function setting level parameters

This command writes an initial setting level parameter, a communication setting level parameter, or an advanced-function setting level parameter.

For details on addressing, refer to **Section 7.10 Variable Area Map**.

Use this command when the product is in setting area 1. If the product is in setting area 0 when receiving the command, it returns an error.

Before issuing the command, use operation instructions to enable “communication writing” and to enter setting area 1.

Response		
MRC	SRC	Response code
"01"	"02"	"0000"

Response code: The code shown above represents normal completion. For details on the response code, refer to **Section 7.6 Write to Variable Area**.

■ Communication Writing

Command

MRC	SRC	Instruction code	Related information
"30"	"05"	"00"	

Related information	Description
"00"	Communication writing disable
"01"	Communication writing enable

This command enables/disables communication writing.

It rewrites the value of the adjustment level parameter “communication writing”.

If communication writing is disabled, operation instructions for parameter rewriting, forced-zero execution/forced-zero cancel and the like are rejected.

This command can be used when the product is in either setting area 0 or 1.

Response

MRC	SRC	Response code
"30"	"05"	"0000"

Response code: The code shown above represents normal completion. For details on the response code, refer to **Section 7.7 Operation Instructions**.

■ Forced-zero Execution/Cancel

Command

MRC	SRC	Instruction code	Related information
"30"	"05"	"03"	

Forced-zero	Description
"00"	Forced-zero cancel
"01"	Forced-forced-zero execution

This command executes/cancels the forced-zero operation.

Use this command when the product is in setting area 0. If product is in setting area 1 when receiving the command, it returns an error.

If the product has no measured value, suffers input anomalies, or encounters a “display range over” error when receiving the command, it returns an error. If the event input is used for “process value hold” when receiving the command, it also returns an error.

Before issuing the command, use an operation instruction to enable “communication writing”.

Response

MRC	SRC	Response code
"30"	"05"	"0000"

Response code: The code shown above represents normal completion. For details on the response code, refer to **Section 7.7 Operation Instructions**.

■ Software Reset

Command

MRC	SRC	Instruction code	Related information
"30"	"05"	"06"	"00"

This command triggers a software reset, which returns the product to its initial state when it was powered on.

It can be used when the product is in either setting area 0 or 1.

Before issuing the command, use an operation instruction to enable “communication writing”.

Response

(Non)

The software reset command does not require the product to return a response.

■ Move to Setting Area 1

Command

MRC	SRC	Instruction code	Related information
"30"	"05"	"07"	"00"

This command provides a transition of the product to setting area 1.

Use this command in setting area 0. If the product is in setting area 1 when receiving the command, the command is ignored.

If the set value of the “initial setting/communication lockouts” parameter is 2 indicating “move to initial setting level” and “move to communication setting level” are disabled (refer to **Section 5.7 Key Protect Setting**) when the product receives the command, the product returns an error.

Before issuing this command, use an operation instruction to enable “communication writing”.

Response

MRC	SRC	Response code
"30"	"05"	"0000"

Response code: The code shown above represents normal completion. For details on the response code, refer to **Section 7.7 Operation Instructions**.

■ Move to Protect Level

Command

MRC	SRC	Instruction code	Related information
"30"	"05"	"08"	"00"

This command moves the product to the protect level.

Use this command when the product is in setting area 0. If the product is in setting area 1 when receiving the command, it returns an error.

Before issuing the command, use an operation instruction to enable “communication writing”.

Response

MRC	SRC	Response code
"30"	"05"	"0000"

Response code: The code shown above represents normal completion. For details on the response code, refer to **Section 7.7 Operation Instructions**.

Read Controller Attribute

Command

MRC	SRC
"05"	"03"

This command reads the model name and communication buffer size of the product.

For addressing, refer to **Section 7.10 Variable Area Map**.

The command can be used, irrespective of what state the product is in.

Response

MRC	SRC	Response code	Model name	Buffer size
"05"	"03"			"0068"

Model name	Buffer size	Input type	Output type	No. of contacts	Optional feature
"K3GN-NDC"	48 × 24	NPN transistor	Relay	2	Communication
"K3GN-PDC"	48 × 24	PNP transistor	Relay	2	Communication
"K3GN-NDT1"	48 × 24	NPN transistor	NPN transistor	3	Communication
"K3GN-PDT2"	48 × 24	PNP transistor	PNP transistor	3	Communication

The model name is expressed in 10-byte ASCII code. If the model name length is less than 10 bytes, blanks are used for padding in the model name field.

A fixed value of "0068H" (104 bytes) in buffer size is returned.

Response code

Response code	Error name	Description
"1001"	Command length over	The command is too long.
"2203"	Operation error	An error occurs in EEPROM.
"0000"	Normal completion	The command is successfully executed.

Read Controller Status

Command

MRC	SRC
"06"	"01"

This command reads the operation status of the product.

The command can be used, irrespective of what state the product is in.

Response

MRC	SRC	Response code	Operation status	Related information
"06"	"01"			

Operation status	Description
"00"	Measurement is in progress normally.
"01"	<ul style="list-style-type: none"> Measurement is suspended. The product has no measured value, suffers input anomalies, or encounters a "display range over" error.

Related information

7	6	5	4	3	2	1	0	Bit position
0	0	0	0	0	0			

Status	Value of bit	
	0	1
No measured value	Not detected	Detected
Display range over	Not detected	Detected
Input anomaly	Not detected	Detected

If the product is in setting area 1 when receiving the command, it returns a response with the "unknown" related information.

Response code

Response code	Error name	Description
"1001"	Command length over	The command is too long.
"2203"	Operation error	An error occurs in EEPROM.
"0000"	Normal completion	The command is successfully executed.

■ Read Version

Command

MRC	SRC	Variable type	Address	Bit position	No. of elements
"01"	"01"	"C0"	"0000"	"00"	"0001"

This command reads the product software version.

The command can be used, irrespective of the state of the product.

Response

MRC	SRC	Response code	Data
"01"	"01"	"0000"	Version No.

Response code: The code shown above represents normal completion. For details on the response code, refer to **Section 7.5 Read from Variable Area**.

■ Echoback Test

Command

MRC	SRC	Data to be tested
"08"	"01"	0 to 87 bytes

This command performs an echoback test.

The command can be used, irrespective of the state of the product.

Data to be checked must not exceed communication data in length.

Communication data length	Description
7 bits	20H to 7EH converted to ASCII code
8 bits	20H to 7EH or A1H to FEH converted to ASCII code

Response

MRC	SRC	Response code	Data to be tested
"08"	"01"		0 to 87 bytes

Response code

Response code	Error name	Description
"1001"	Command length over	The command is too long.
"2203"	Operation error	An error occurs in EEPROM.
"0000"	Normal completion	The command is successfully executed.

7.10 Variable Area Map

The variable area of the product is mapped in terms of variable types and addresses as described below.

Variable type C0: Read-only data including process values and status

Variable type C1: Protect level parameters

Variable type C2: Operation level parameters (OUT set values and remote input values)

Variable type C3: Initial setting, communication setting, and advanced-function setting level parameters

The address and parameter assignments to each variable type are shown below.

Variable type	Address	Parameter	Meaning of set value/Valid range/Description
C0	0000	Version	00000100H
	0001	Current value	FFFFB1E1H to 0001869FH (–19999 to 99999): Valid 0001869FH (99999): Input anomalous/outside the display range upper limit FFFFB1E1H (–19999): Input anomalous/outside the display range lower limit
	0002	Status	Refer to the figure below.

Status description

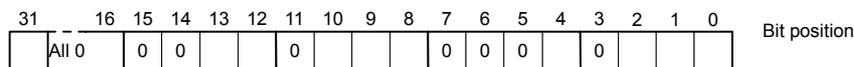

The event input is ON only when the input type is set to "analog" and assigned "HOLD". Otherwise, it is OFF.

Even if the product is of relay output type, the PASS output status can assume ON and OFF.

Status	Value of bit	
	0	1
No measured value	Not detected	Detected
Display range over	Not detected	Detected
Input anomaly	Not detected	Detected
Event input	OFF	ON
Comparative output 1	OFF	ON
Comparative output 2	OFF	ON
PASS output	OFF	ON
Setting area	Setting area 0	Setting area 1
Data writing	Disable	Enable

Variable type	Address	Parameter	Meaning of set value/Valid range/Description
C1	0000	Operation/adjustment lockouts	00000000H (0): No restriction at the operation/adjustment levels 00000001H (1): "Move to adjustment level" is disabled. 00000002H (2): Only the process value can be displayed. Access via communications is enabled, irrespective of the value of this parameter.
	0001	Initial setting/communication lockouts	00000000H (0): "Move to initial setting/communication setting/advanced-function setting levels" is enabled. 00000001H (1): "Move to advanced-function setting level" is disabled. 00000002H (2): "Move to initial setting/communication setting levels" is disabled. Access via communications is enabled, irrespective of the value of this parameter.
	0002	Setting change lockout	00000000H (0): OFF: A parameter change by key operation is enabled. 00000001H (1): ON: A parameter change by key operation is disabled. Communication writing is enabled, irrespective of the value of this parameter.
	0003	Forced-zero lockout	00000000H (0): OFF: Forced-zero execution/forced-zero cancel is enabled. 00000001H (1): ON: Forced-zero execution/forced-zero cancel is disabled. Communication writing is enabled, irrespective of the value of this parameter.
C2	0000	Remote input value	FFFFB1E1H to 0001869FH (-19999 to 99999) An input value is written to this variable when the product is used as a digital data display for PLC/PC.
	0001	OUT1 value	FFFFB1E1H to 0001869FH (-19999 to 99999)
	0002	OUT1 upper-limit value	FFFFB1E1H to 0001869FH (-19999 to 99999)
	0003	OUT1 lower-limit value	FFFFB1E1H to 0001869FH (-19999 to 99999)
	0004	OUT2 value	FFFFB1E1H to 0001869FH (-19999 to 99999)
	0005	OUT2 upper-limit value	FFFFB1E1H to 0001869FH (-19999 to 99999)
	0006	OUT2 lower-limit value	FFFFB1E1H to 0001869FH (-19999 to 99999)

Variable type	Address	Parameter	Meaning of set value/Valid range/Description
C3	0000	Input type	00000000H (0): Analog 00000001H (1): Pulse 00000002H (2): Remote
	0001	Analog range	00000000H (0): 4 to 20 mA/0 to 20 mA 00000001H (1): 1 to 5 V/0 to 5 V 00000002H (2): ±5 V 00000003H (3): ±10 V
	0002	Input pulse frequency	00000000H (0): 30 Hz 00000001H (1): 5 kHz
	0003	Scaling input value 1	FFFFB1E1H to 0001869FH (-19999 to 99999)
	0004	Scaling display value 1	FFFFB1E1H to 0001869FH (-19999 to 99999)
	0005	Scaling input value 2	FFFFB1E1H to 0001869FH (-19999 to 99999)
	0006	Scaling display value 2	FFFFB1E1H to 0001869FH (-19999 to 99999)
	0007	Scaling input value	FFFFB1E1H to 0001869FH (-19999 to 99999): When the input type is set to "pulse"
0008	Scaling display value	FFFFB1E1H to 0001869FH (-19999 to 99999): When the input type is set to "pulse"	

Variable type	Address	Parameter	Meaning of set value/Valid range/Description
C3	0009	Decimal point position	00000000H (0): 0.0000 00000001H (1): 0.0000.0 00000002H (2): 0.00.00 00000003H (3): 00.0000 00000004H (4): 0.00000
	000A	OUT1 type	00000000H (0): Upper-limit action 00000001H (1): Lower-limit action 00000002H (2): Outside-the-range action
	000B	OUT2 type	00000000H (0): Upper-limit action 00000001H (1): Lower-limit action 00000002H (2): Outside-the-range action
	000C	Communication unit No	00000000H ~ 00000063H (0 ~ 99)
	000D	Baud rate	00000000H (0): 1.2 kbps 00000001H (1): 2.4 kbps 00000002H (2): 4.8 kbps 00000003H (3): 9.6 kbps 00000004H (4): 19.2 kbps
	000E	Word length	00000000H (0): 7 bits 00000001H (1): 8 bits
	000F	Stop bit length	00000000H (0): 1 bit 00000001H (1): 2 bits
	0010	Parity bits	00000000H (0): Non 00000001H (1): Even 00000002H (2): Odd
	0011	No. of measurements for averaging	00000000H (0): OFF 00000001H (1): 2 00000002H (2): 4 00000003H (3): 8
	0012	Event input function	00000000H (0): HOLD 00000001H (1): ZERO
	0013	OUT1 hysteresis	00000000H to 0000270FH (0 to 9999)
	0014	OUT2 hysteresis	00000000H to 0000270FH (0 to 9999)
	0015	Auto-zero time	00000000H to 000000C7H (0.0 to 19.9)
	0016	Startup compensation time	00000000H to 000003E7H (0.0 to 99.9)
	0017 to 0019	(Not assigned)	00000000H (0)
	001A	Display color change	00000000H (0): Green to red 00000001H (1): Always green 00000002H (2): Red to green 00000003H (3): Always red
	001B	Display auto-return time	00000000H to 00000063H (0 to 99)
001C	Move-to-protect-level time	00000000H to 00000013H (0 to 19)	
001D	Send waiting time	00000000H to 00000063H (0 to 99)	

TIPS

Block access to the variable area

A number of contiguously addressed variables of the same type in the variable area can be accessed at a time. For example, you can read the current value and the status simultaneously by setting the read start address to the address of the current value and setting the No. of elements to 2.

Such an access method is called "block access".

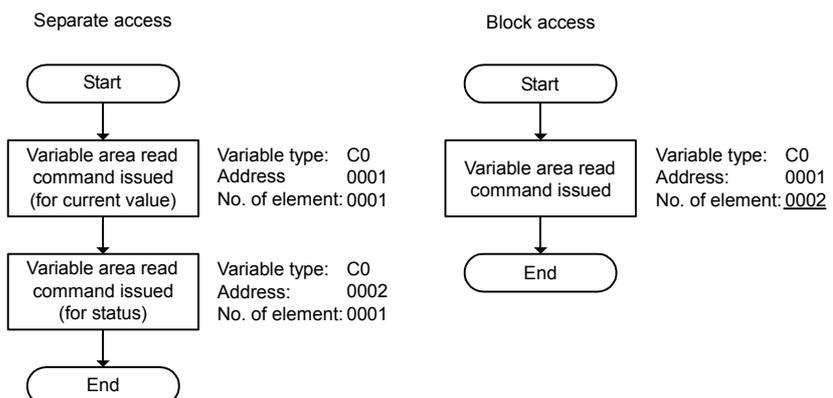

7.11 Communications Control Flow

This section describes the control flow of communications between the product and the host PC. Information in this section will help you make up a program for controlling the product.

■ Communication Reading

Communication reading is performed according to the following flow. It involves no response from the product to the host PC.

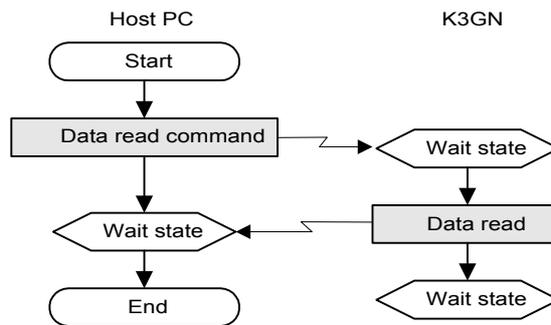

Commands applicable to this flow are shown below.

Applicable commands
Read process value
Read status
Read OUT set value
Read parameter
Read controller attribute
Read controller status
Read version
Echoback test

■ Communication Writing (Setting Area 0)

When the product is in setting area 0, communication writing is performed according to the following flow.

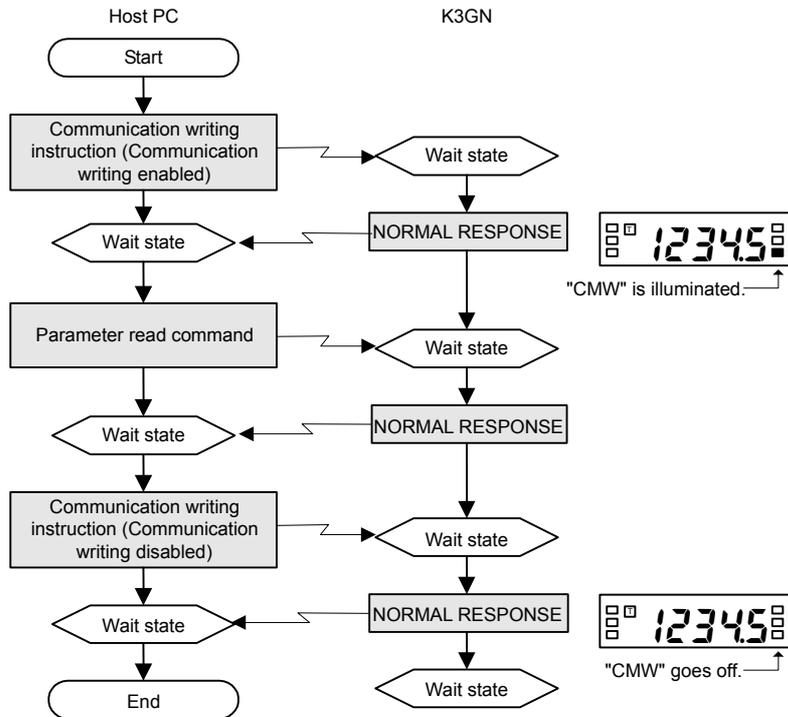

Commands applicable to this flow are as follow.

Applicable commands
Write remote input value
Write OUT set value

Remote input values would often be written with a high frequency. You should therefore keep “communication writing” in “enable” state and then continuously write input values. Doing so will shorten the time for communication writing.

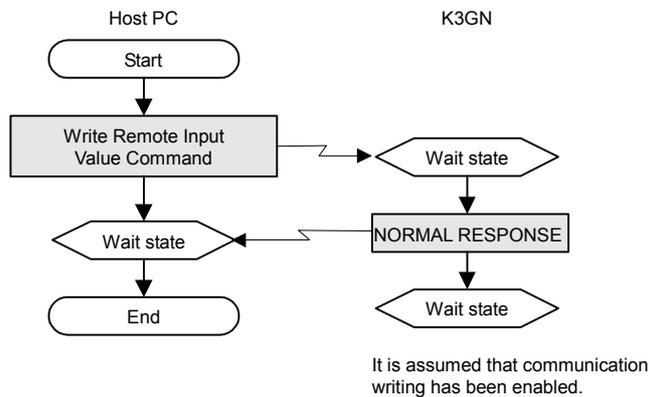

■ Protect Level Parameter Writing

A protect level parameter is written according to the following flow.

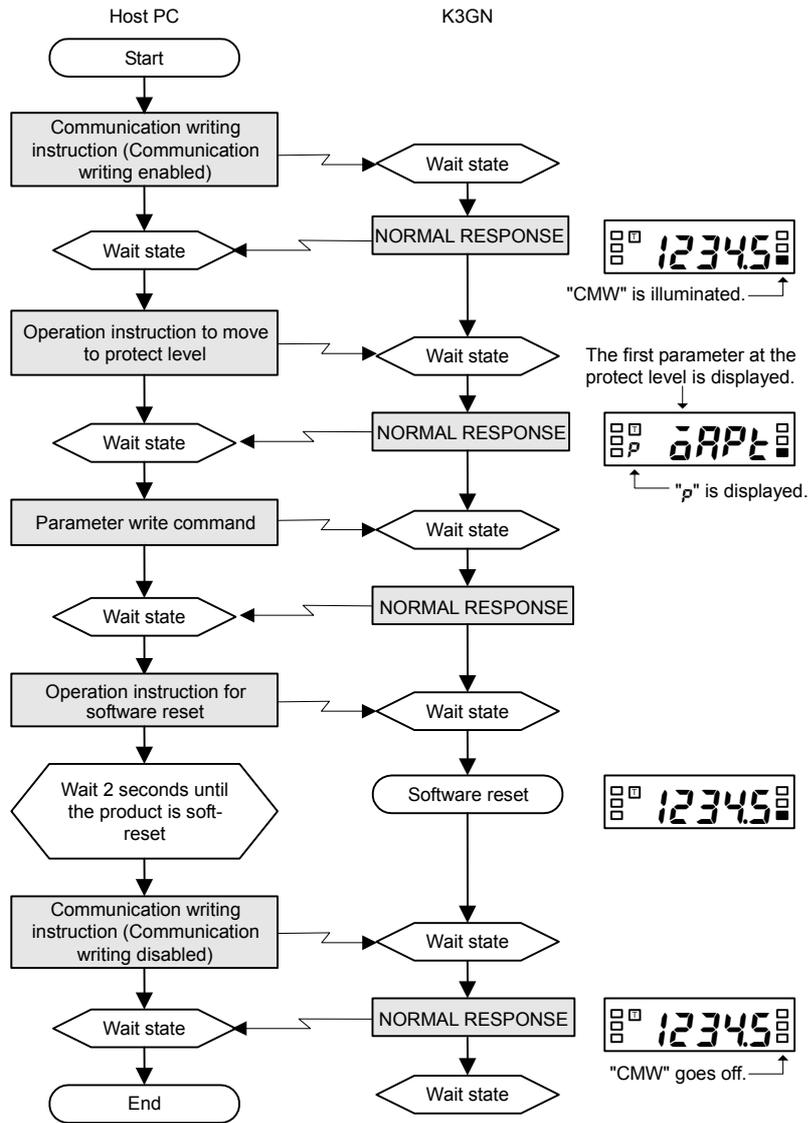

The following command is applicable to this flow.

Applicable command
Write protect level parameter

■ Parameter Writing (Setting Area 1)

When the product is in setting area 1, a parameter is written according to the following flow.

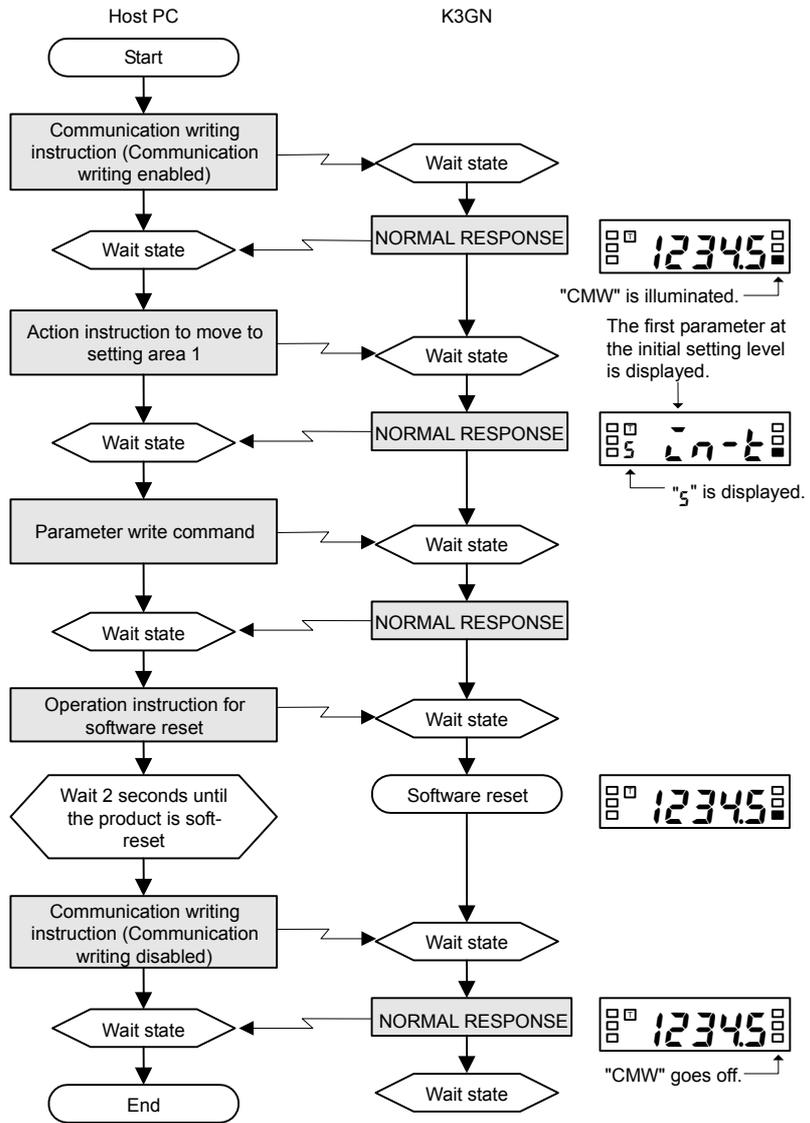

The following command is applicable to this flow.

Applicable command
Write parameter (setting area 1)

■ Operation Instruction

An operation instruction is performed according to the following flow.

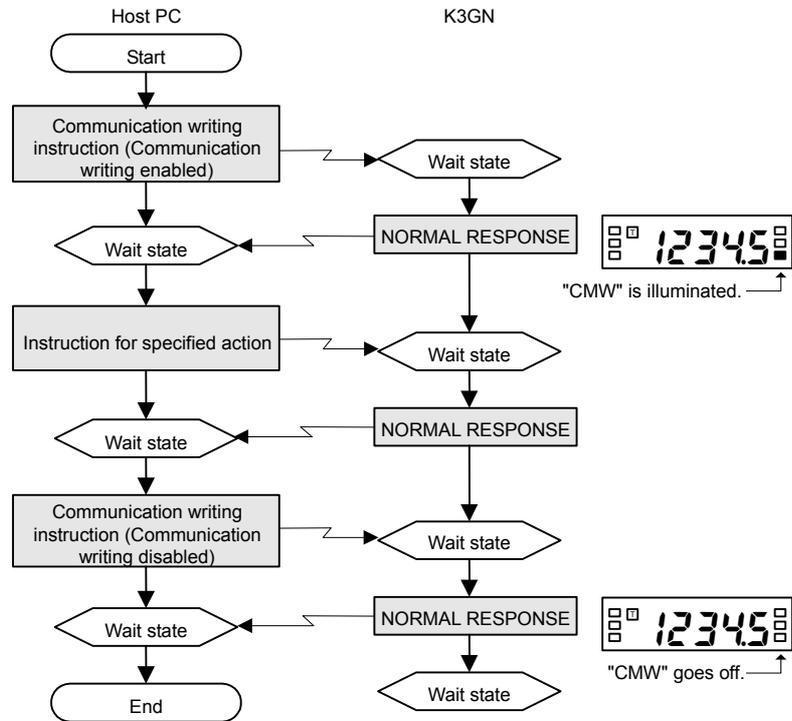

Commands applicable to this flow are shown below.

Applicable commands
Forced-forced-zero execution/cancel
Move to setting area 1
Move to protect level

7.12 Programming Example

■ N88 BASIC

The section shows a programming example where a response from the product is displayed on the screen on the host PC when a command is entered from the keyboard.

This program is created with N88 BASIC.

```

1000 '-----
1010 'PROGRAM: K3GN Communication Sample Program(CompoWay/F)
1020 'VERSION:1.00
1030 '(C)Copyright OMRON Corporation 1999
1040 'All Rights Reserved
1050 '-----
1060 '
1070 '=====  
Baud rate setting (PARITY=EVEN,DATA=7,STOP=2) =====
1080 'COM port settings
1090 OPEN "COM:E73" AS #1
1100 '
1110 *REPEAT
1120 '
1130 '=====  
Transmission processing =====
1140 '
1150 '-----SD input-----
1160 INPUT "SEND DATA:",SEND$
1170 '
1180 '-----If not input, go to end processing-----
1190 "IF SEND$ = "" THEN *EXIT
1200 '
1210 '-----BCC calculation-----
1220 BCC = 0
1230 SEND$ = SEND$+CHR$(3)
1240 FOR I=1 TO LEN(SEND$)
1250 " BCC = BCC XOR ASC(MID$(SEND$,I,1))
1260 NEXT I
1270 BCC$ = CHR$(BCC)
1280 '
1290 '-----Transmission-----
1300 SDATA$ = CHR$(2)+SEND$+BCC$
1310 PRINT #1,SDATA$;
1320 '
1330 '=====  
Reception processing=====
1340 '
1350 RDATA$ = ""
1360 TIMEOUT = 0
1370 *LOOP
1380 '-----No-response detection-----
1390 TIMEOUT = TIMEOUT+1
1400 IF TIMEOUT > 2000 THEN RESP$ = "No Response":GOTO *REND
1410 IF LOC(1) = 0 THEN *LOOP
1420 '
1430 '-----Ending character identification (if not ending character,
continue reading)
1440 RDATA$ = RDATA$+INPUT$(LOC(1),#1)
1450 IF LEN(RDATA$) < 2 THEN *LOOP
1460 IF MID$(RDATA$,LEN(RDATA$)-1,1) <> CHR$(3) THEN *LOOP
1470 RESP$ = MID$(RDATA$,2,LEN(RDATA$)-2)
1480 *REND

```



```

1490  '
1500  '-----Received data display-----
1510  PRINT "RESPONSE:";RESP$
1520  GOTO *REPEAT
1530  '
1540  *EXIT
1550  '=====  
Termination  
=====
1560  CLOSE #1
1570  END
    
```

● Execution example

The current value of unit No. 00 is read.

```

RUN
SEND DATA:000000101C00001000001
RESPONSE:0000001010000000014F
    
```

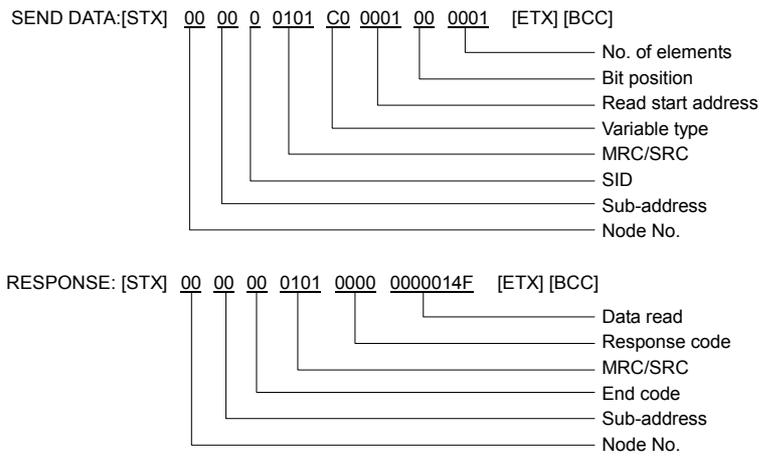

Protocol Macro

What is the protocol macro?

The protocol macro is a ladder routine that, using a PMCR command, provides control to the sequence (protocol) of data communications between PLCs or other communication devices connected via RS-232C or RS-422A/485 interface.

OMRON's CS1W series of serial communication boards come standard with a standard system protocol that allows control of OMRON's components.

For details on the protocol macro, refer to the User's Manual for Model CS1W-SCB21/41/-SCU21 (Cat. No. W336-01).

Connection

The serial communication board CS1W-SCB41 has two ports, port 2 of which allows direct connection via RS-485 interface.

Use this port to connect the board to the product.

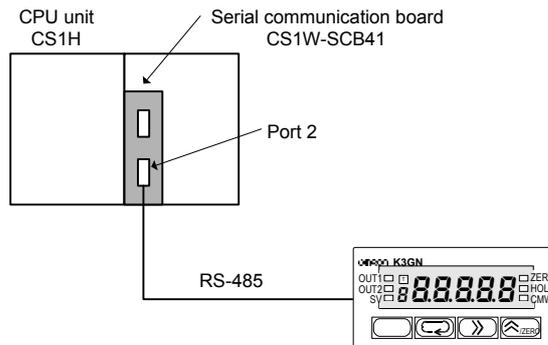

Set the TERM switch to "ON" and the WIRE switch to "2" and connect a terminator to the K3GN.

Ladder Example

The following example is a ladder diagram in which the current process value is read through communications (with responses) with No. 600 ASCII conversion according to the standard system protocol "CompoWay/F for Master Station".

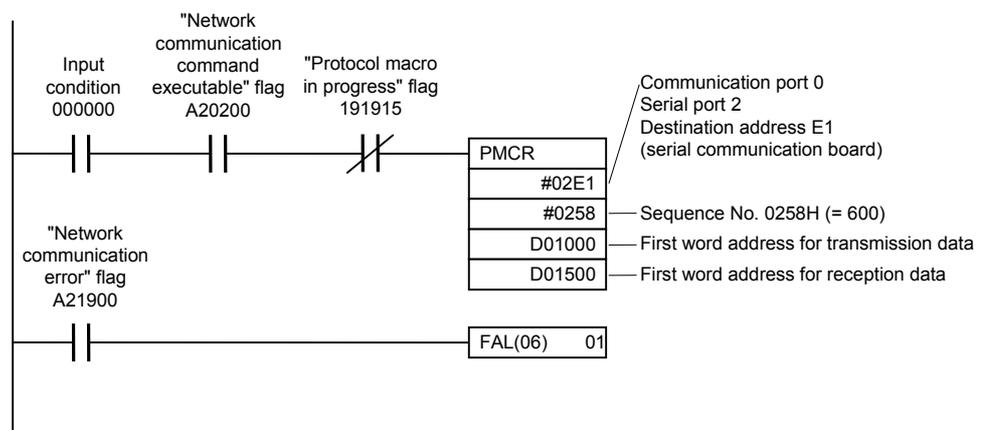

Placing the "read process value" command in D0100 or a higher-numbered location causes the process value to be stored in D0152 ~ D0153.

If a communication error occurs, an FAL command (fault analysis command) is executed.

● Data transmission word assignment

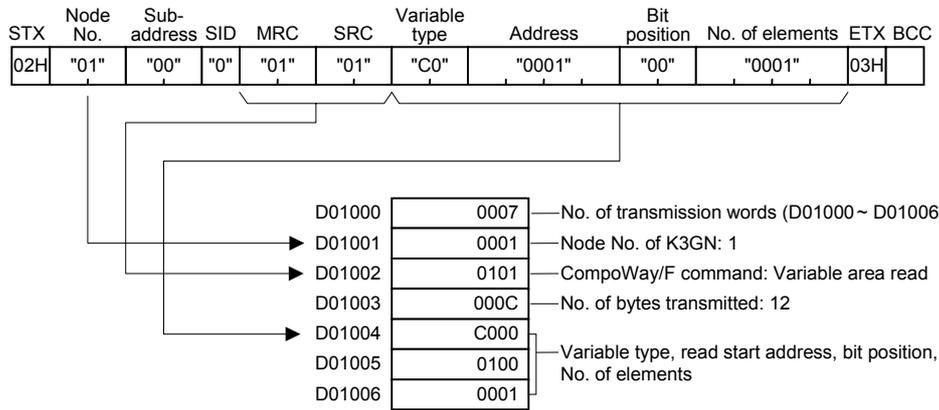

● Data reception word assignment

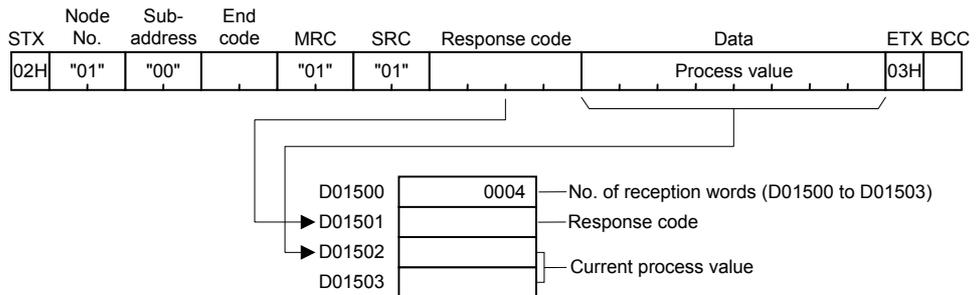

CHAPTER

8

USER CALIBRATION

The product allows the user to perform analog input calibration. This chapter outlines user calibration and describes how to calibrate the product.

8.1	User Calibration	128
8.2	User Calibration Processes	130
	Connection of the Product to a STV/Calibration Procedure	

8.1 User Calibration

As the product has been calibrated at the factory, it does not need to be calibrated in normal use.

The product has the capability of analog input calibration, which enables user calibration as needed.

OMRON assumes no responsibility for the result of user calibration.

Note that, once user calibration is performed, original calibration data is overwritten and cannot be restored.

Devices and tools necessary for user calibration must be made available by the user. For handling of these devices, refer to their respective manuals.

Entry of Calibration data

First store both of calibration values 1 and 2 temporarily. Then save them while the product is in the change state.

Calibration data cannot be saved normally unless calibration values 1 and 2 are both specified.

If calibration data is saved normally, the product keeps a record of the user calibration. When you enters the user calibration level, a calibration record mark will appear on the main indicator as shown below.

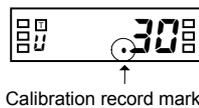

Calibration Flow

The following shows the flow of user calibration.

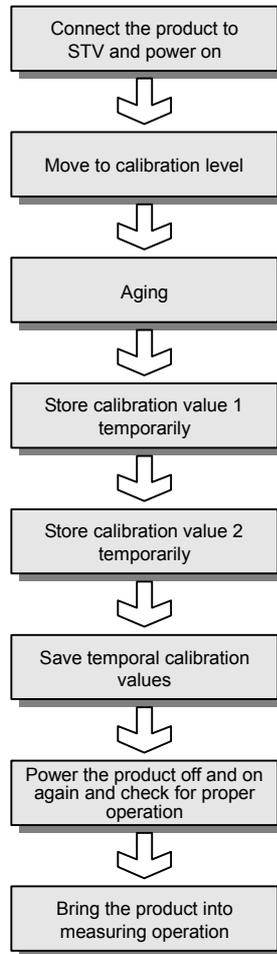

In the above flow, a range specified by the “analog range” parameter undergoes calibration.

If you want to calibrate another range, change the analog range to the desired one at the initial setting level and then perform calibration according to the above flow.

To exit from the calibration level, power the product off and on again.

8.2 User Calibration Processes

■ Connection of the Product to a STV

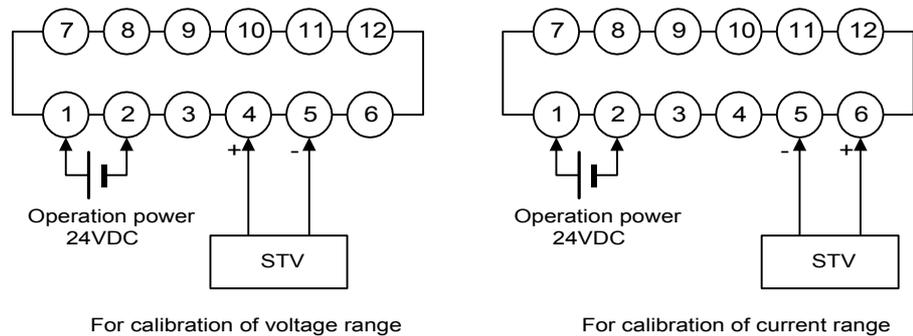

Connect a STV (standard voltage/current generator) to appropriate terminals as shown above.

Use a STV that has accuracy appropriate to the precision of the product.

■ Calibration Procedure

Take the following steps for user calibration.

Move to the Calibration Level

Procedure

A. At the advanced-function setting level, press the key.

- Parameter $\text{E} \cdot \text{h} \cdot \text{a} \cdot \text{w}$ will appear on the main indicator.
- If you cannot move to the calibration level at the first attempt after purchasing the product, set the "initial setting/communication lockout" parameter to "0" at the protect level and then move to the advanced-function setting level.

B. Press the key.

- The set value (password) of the parameter will appear on the main indicator.

C. Press the key again to allow the password to be changed.

D. Use the and keys to enter a password of "01201".

E. Press the key to save the password.

- If the password is correct, the product enters the calibration level.
- If the password is incorrect, the product remains at the advanced-function setting level and its main indicator displays the next parameter.

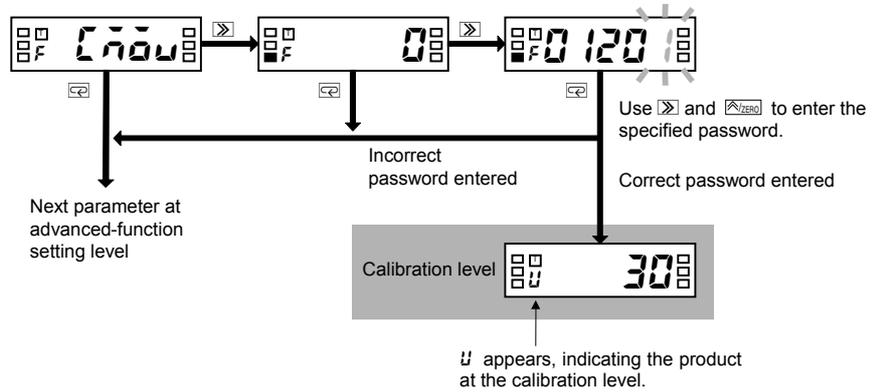

At the Calibration Level

Procedure

A. Follow the above steps to move to the calibration level.

- An aging timer count will appear on the main indicator.
- The aging timer is a 30-minute timer and counts down to 0.
- If a user calibration record is found, a calibration record mark will appear.



Calibration record mark

B. Perform aging until the aging timer counts down to 0. (If the STV needs an aging time longer than 30 minutes, continue aging until the aging requirement of the STV is satisfied).

- If you press the key in the middle of timer counting, aging is skipped and the parameter of calibration value 1 is displayed on the main indicator.



C. Press the key to display the parameter of calibration value 1.

- The parameter corresponding to the current analog range will appear on the main indicator. For the relationship between the analog range and the parameter, refer to the table on the next page.

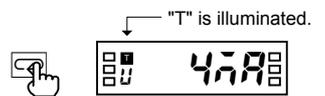

"T" is illuminated.

D. Press the key to display the set value of the parameter.

- The calibration value 1 will appear in hexadecimal on the main indicator.

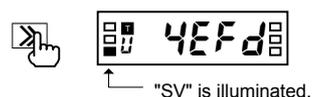

"SV" is illuminated.

E. Use the STV to provide a reference signal corresponding to calibration value 1.

- For the value of reference signals, refer to the table on the next page.

F. Press the  key.

- The teaching indicator will start blinking, indicating the reference signal is given to the product.

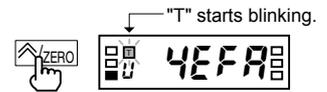

G. Press the  key again to temporarily store calibration value 1.

- If you press the  key instead of the  key, calibration value 1 is not stored and the parameter of calibration value 2 is displayed on the main indicator.



H. Press the  key to display the parameter of calibration value 2.



I. Repeat steps **D** to **H** to temporarily store calibration value 2.

- Parameter **5tr** will appear on the main indicator, indicating the temporal calibration values can be saved.
- This parameter does not appear unless both calibration values 1 and 2 have been stored temporarily.

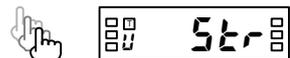

J. Press the  key to display the set value.

- **n0** will appear on the main indicator.

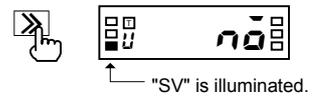

K. Press the  key again.

- The set value will start blinking, indicating the product is in the change state.



L. Press the  key.

- **YES** will appear on the main indicator.



M. Press the  key.

- The calibration values are saved.
- The aging timer count will appear on the main indicator.

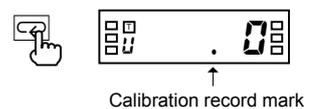

N. Power the product off and on again to exit from the calibration level, and check for proper operation.

• Analog ranges and parameters/reference signals

Analog range	Calibration value 1		Calibration value 2	
	Parameter	Reference signal	Parameter	Reference signal
4 to 20 mA	4mA	4.00 mA	20mA	20.00 mA
1 to 5V	1V	1.000V	5V	5.000V
±5V	5V	5.000V	-5V	-5.000V
±10V	10V	10.000V	-10V	-10.000V

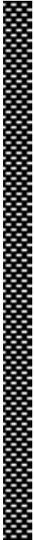

CHAPTER

9

TROUBLESHOOTING GUIDE

This chapter shows the meanings of error indications and the remedial actions to be taken in the event of error. It also contains a troubleshooting table that will be helpful in case a trouble may arise.

9.1	Error Indications	134
9.2	Troubleshooting Table	135

9.1 Error Indications

Level indicator	Main indicator	Error description	Remedy										
(Off)	E 111	RAM error	Turn the K3GN off and on again. <ul style="list-style-type: none"> • If the error persists, RAM needs to be replaced. • If the product is restored to normal operation, the error was possibly caused by noise interference. Check for noise source near the product. 										
5	E 111	EEPROM error	Turn the K3GN off and on again. <ul style="list-style-type: none"> • If the error persists, EEPROM needs to be replaced. • If the product is restored to normal operation, the error was possibly caused by noise interference. Check for noise source near the product. 										
(Off)	5Err blinking at intervals of 0.5 s	<p>The product received an analog value that fell outside the measuring range of the selected analog range.</p> <p>You will see this indication when turning on the product at the first time after purchasing. This is because the input signal value is 0 mA at that time even though the range is factory set to 4 to 20 mA.</p>	<p>Supply analog values that fall within the measuring range.</p> <p>The measuring range of each analog range is as follows.</p> <table border="1"> <thead> <tr> <th>Analog range</th> <th>Measuring range</th> </tr> </thead> <tbody> <tr> <td>4 to 20 mA</td> <td>0 to 22 mA</td> </tr> <tr> <td>1 to 5V</td> <td>0 to 5.5V</td> </tr> <tr> <td>±5V</td> <td>–5.5 to 5.5V</td> </tr> <tr> <td>±10V</td> <td>–11 to 11V</td> </tr> </tbody> </table> <p>At the initial setting level, select an input type and an analog range according to your application.</p>	Analog range	Measuring range	4 to 20 mA	0 to 22 mA	1 to 5V	0 to 5.5V	±5V	–5.5 to 5.5V	±10V	–11 to 11V
Analog range	Measuring range												
4 to 20 mA	0 to 22 mA												
1 to 5V	0 to 5.5V												
±5V	–5.5 to 5.5V												
±10V	–11 to 11V												
(Off)	99999 blinking at intervals of 0.5 s	The scaling display value exceeds 99999.	<p>Enter an appropriate scaling input value.</p> <p>The scaling factor may be inappropriate. Review the scaling factor at the initial setting level.</p>										
(Off)	-19999 blinking at intervals of 0.5 s	The scaling display value is lower than –19999.	<p>Enter an appropriate scaling input value.</p> <p>The scaling factor may be inappropriate. Review the scaling factor at the initial setting level.</p>										

9.2 Troubleshooting Table

Symptom	Probable cause	Remedy	Reference page
The forced-zero function is inoperative even though the  key is pressed.	The “input type” parameter is set to “pulse”.	The forced-zero function is not available.	50 92
	Forced-zero lockout is active.	At the protect level, set the forced-zero function to “enable”.	48
The product does not enter the protect level even though the  +  is held down for 5 seconds.	The “move-to-protect-level” parameter is set to a value more than 5.	Set the “move-to-protect-level” parameter to an appropriate value.	79
Readouts vary greatly or decrease with increasing rotational speed.	The “input-pulse frequency range” parameter is set to “30 Hz”.	If the input pulse frequency exceeds 30 Hz, set the “input-pulse frequency range” parameter to “5 kHz”.	52 90
	The input pulse frequency exceeds 5 kHz.	Lower the input pulse frequency to 5 kHz or less. Note that the product does not generate an out-of-range error if the input pulse frequency exceeds 5 kHz.	
Readouts vary or are incorrect even when the rotational speed is low.	The pulse width of ON/OFF signals is too small.	Supply the product with pulses that have a width specified in this manual. The product cannot recognize input pulses correctly unless their width is as specified, even if the rotational speed is low.	90
The main indicator reads 0 when the rotational speed is low.	The “auto-zero time” parameter is set to a value that is not more than the maximum time interval of input pulses.	Set the “auto-zero time” parameter to a value exceeding the maximum time interval of input pulses.	71
		Otherwise, the auto-zero function may be triggered improperly.	88

Symptom	Probable cause	Remedy	Reference page
The product continues to read "00000" on the main indicator since powered on.	The set value of the "startup compensation timer" parameter is too large.	Set the "startup compensation timer" parameter to an appropriate value. When the input type is set to "pulse", the startup compensation time can be set to up to 99.9 seconds.	73 88
	The "process value hold" function is active.	Cancel "process value hold". If the event input terminal is used for "process value hold", powering on the product in the ON state of the terminal will result in a readout of "00000", which is retained unless the terminal turns off.	91
The event/pulse input terminals cannot be turned on or off at all or sometimes.	The making residual current and/or breaking leakage current of input equipment are outside the specified limits.	Use such input equipment that conforms to the requirements of the making residual current and breaking leakage current specifications. Otherwise, the product cannot detect the ON/OFF signals from input equipment.	13
The product does not return responses at all to the host PC.	Wiring is incorrect.	Check wiring for correct connection and A/B polarity.	14
	The command frame contains a wrong unit No.	Specify a correct unit No. Otherwise, the product will not return a response to the host PC.	99
Comparative output does not turn off even when a process value goes back to normal.	The set value of the "hysteresis" parameter is too large.	Set the "hysteresis" parameter to an appropriate value.	69
			94



APPENDIX

Specifications	138
Parameter List	142
ASCII Code Table	143



Specifications

■ Ratings

Supply voltage	24 VDC
Operating voltage range	85% to 110% of the rated supply voltage
Power consumption (see note)	2.5W max. (at max. DC load with all indicators lit)
Insulation resistance	20 M Ω min. (at 500 VDC) between external terminal and case. Insulation provided between inputs, outputs, and power supply.
Dielectric withstand voltage	1,000 VAC for 1 min between external terminal and case. Insulation provided between inputs, outputs, and power supply.
Noise immunity	\pm 480 V on power supply terminals in normal mode, \pm 1,500 V in common mode, \pm 1 μ s, or 100 ns for square-wave noise with 1 ns
Vibration resistance	Malfunction: 10 to 55 Hz, 10 min each in X, Y, and Z directions; acceleration: 9.8 m/s ² Destruction: 10 to 55 Hz, 30 min each in X, Y, and Z directions; acceleration: 19.6 m/s ²
Shock resistance	Malfunction: Models with transistor outputs: 196 m/s ² for 3 times each in X, Y, and Z directions Models with relay contact outputs: 98 m/s ² for 3 times each in X, Y, and Z directions Destruction: 294 m/s ² for 3 times each in X, Y, and Z directions
Ambient temperature	Operating: -10°C to 55°C (with no condensation or icing) Storage: -25°C to 65°C (with no condensation or icing)
Ambient humidity	Operating: 25% to 85% (with no condensation)
Ambient atmosphere	Must be free of corrosive gas
EMC	Emission Enclosure: EN55011 Group 1 class A Emission AC Mains: EN55011 Group 1 class A Immunity ESD: EN61000-4-2: 4-kV contact discharge (level 2) 8-kV air discharge (level 3) Immunity-RF-interference: ENV50140: 10 V/m (amplitude modulated, 80 MHz to 1 GHz) (level 3) 10 V/m (pulse modulated, 900 MHz) Immunity Conducted Disturbance: ENV50141: 10 V (0.15 to 80 MHz) (level 3) Immunity Burst: EN61000-4-4: 2-kV power line (level 3) 2-kV I/O signal-line (level 4)
Approved standards	UL508 (pending), CSA22.2 (pending); conforms to EN50081-2, EN50082-2, EN61010-1 (IEC61010-1); conforms to VDE106/part 100 (Finger Protection) when the terminal cover is mounted.
Weight	Approx. 100 g

Note: A operation power supply capacity greater than the rated capacity is required when the Digital Panel Meter is turned ON. Do not forget to take this into consideration when using several Digital Panel Meters. When power is supplied, all indicators will light and outputs will be OFF. When using startup compensation time operation, the display will read "00000" and all outputs will be OFF.

■ Input/Output Ratings

Relay Contact Output

(Incorporating G6K Relays)

Item	Resistive load ($\cos\theta = 1$)
Rated load	1 A at 30 VDC
Rated carry current	1 A max. (at COM terminal)
Max. contact voltage	60 VDC
Max. contact current	1 A (at COM terminal)
Max. switching capacity	30 VA
Min. permissible load (P level, reference value)	10 mV, 10 μ A
Mechanical life	50,000,000 times min. (at a switching frequency of 36,000 times/hr)
Electrical life (at an ambient temperature of 23°C)	100,000 times min. (at the rated load with a switching frequency of 1,800 times/hr)

Transistor Output

Rated load voltage	24 VDC
Max. load current	50 mA
Leakage current	100 μ A max.

Linear current output

Item	0 to 20 mA DC, 4 to 20 mA DC
Load	500 Ω max.
Resolution	Approx. 10,000.
Output error	$\pm 0.5\%$ of F.S.

Linear voltage output

Item	0 to 5V DC, 1 to 5V DC, 0 to 10V DC
Load	5k Ω min.
Resolution	Approx. 10,000.
Output error	$\pm 0.5\%$ of F.S. (but $\neq 0.15$ V, 0V for 1V or less)

■ Communications

Item	RS-485
Transmission method	2-wire, half-duplex
Synchronization method	Start-stop synchronization
Baud rate	1,200/2,400/4,800/9,600/19,200 bps
Transmission code	ASCII
Communications	Reading/Writing to the K3GN
	Read/write set values, read/write scaling values, enable/disable the writing of data through communications, forced-zero control, and other data.

■ Measuring Ranges

Process Voltage/Current Inputs

Input	Measuring range	Measuring accuracy	Input impedance	Display range
DC voltage	1.000 to 5.000 V/ 0.000 to 5.000 V	$\pm 0.1\%$ FS ± 1 digit max. (at $23\pm 3^\circ\text{C}$)	1 M Ω min.	-19999 to 99999 (with scaling function)
	-5.000 to 5.000 V	$\pm 0.1\%$ FS ± 1 digit max. (at $23\pm 5^\circ\text{C}$)		
	-10.00 to 10.00 V			
DC current	4.00 to 20.00 mA/ 0.00 to 20.00 mA	$\pm 0.1\%$ FS ± 1 digit max. (at $23\pm 3^\circ\text{C}$)	60 Ω	

No-voltage Contact/Open Collector Inputs

Input	Measuring range	Measuring accuracy (at $23\pm 5^\circ\text{C}$)	Displayable range
No-voltage contact (30 Hz max.) with ON/Off pulse width of 16 ms min.	0.05 to 30.00 Hz	$\pm 0.1\%$ FS ± 1 digit max.	-19999 to 99999 (with scaling function)
Open collector (5 kHz max.) with ON/OFF pulse width of 90 μs min.	0.1 to 5000.0 Hz		

Digital Data Display (By RS-485 Communication)

Displayable range	-19999 to 99999
-------------------	-----------------

■ Characteristics

Input signal	Process voltage (1 to 5V, 0 to 5V, $\pm 5V$, $\pm 10V$) Process current (4 to 20 mA, 0 to 20 mA)	No-voltage contact (30 Hz max. with ON/OFF pulse width of 16 ms min.) Open collector (5 kHz max. with ON/OFF pulse width of 90 μ s min.)	Digital data display (by RS-485 communication)
A/D conversion method	Double integral method	—	
Sampling period	250 ms	—	
Display refresh period	Sampling period (sampling times multiplied by number of averaging times if average processing is selected.)		
Pulse measurement method	—	Periodic measurement	—
Connectable Sensors	—	ON residual voltage: 2.5 V max. OFF leakage current: 0.1 mA max. Load current: Must have a switching capacity of 15 mA min. Must be able to reliably switch load currents of 5 mA max.	
Max. displayed digits	5 digits (–19999 to 99999)		
Display	7-segment digital display, character height: 7.0 mm		
Polarity display	“–” is displayed automatically with a negative input signal.		
Zero display	Leading zeros are not displayed.		
Scaling function	Programmable with front-panel key inputs (range of display: –19999 to 99999). The decimal point position can be set as desired.		
External controls (see note 1)	HOLD: (Measurement value held) ZERO: (Forced-zero)	—	HOLD: (Measurement value held) ZERO: (Forced-zero)
Hysteresis setting	Programmable with front-panel key inputs (0001 to 9999)		
Other functions	Programmable Color Display Selectable output operating action Teaching set values Average processing (simple average) Lockout configuration Communications writing control (communications output models only)		
	Forced-zero set with front panel keys Control inputs (HOLD/ZERO) selection via front panel keys Field calibration	Startup compensation time (0.00 to 99.9 s) Auto-zero time (0.0 to 19.9 s)	Forced-zero set with front panel keys Control inputs (HOLD/ZERO) selection via front panel keys
Output	Relays: 2 SPST-NO Transistors: 3 NPN open collector 3 PNP open collector Linear: Current output Voltage output	—	
	Combinations: Communications output (RS-485) + relay outputs (2 SPST-NO); Communications output (RS-485) + transistor outputs (3 NPN open collector); Communications output (RS-485) + transistor outputs (3 PNP open collector); Linear current output + relay outputs (2 SPST-NO); Linear voltage output + relay outputs (2 SPST-NO); Linear current output + transistor outputs (3NPN open collector); Linear voltage output + transistor outputs (3NPN open collector)		
Communications	Communications function: RS-485		
Delay in comparative outputs (transistor outputs)	750 ms max.		
Enclosure ratings	Front panel: NEMA4X for indoor use (equivalent to IP66) Rear case: IEC standard IP20 Terminals: IEC standard IP20		
Memory protection	Non-volatile memory (EEPROM) (possible to rewrite 100,000 times)		

Note 1: The minimum input time for control signals is 80 ms.

Parameter List

Use this list to note your set values.

Level	Parameter	Indication	Setting range	Default	Unit	Set value
Protect	Operation/adjustment lockouts	ōAPŁ	0 ~ 2	0		
	Initial setting/communication lockouts	ŁCPŁ	0 ~ 2	1		
	Setting change lockout	ŸŁPŁ	ōFF/ōn	ōFF		
	Forced-zero lockout	ŁrPŁ	ōFF/ōn	ōFF		
Operation	OUT1 value	ōŸŁ 1	-19999 ~ 99999	99999		
	OUT1 upper-limit value	ōŸŁ 1H	-19999 ~ 99999	99999		
	OUT1 lower-limit value	ōŸŁ 1L	-19999 ~ 99999	-19999		
	OUT2 value	ōŸŁ 2	-19999 ~ 99999	-19999		
	OUT2 upper-limit value	ōŸŁ 2H	-19999 ~ 99999	99999		
	OUT2 lower-limit value	ōŸŁ 2L	-19999 ~ 99999	-19999		
Adjustment	Communication writing	ŁŃŸŁ	ōFF/ōn	ōFF		
Initial setting	Input type	ŁnŁ	RnRLŁ/PUL SE/rŃŁ	RnRLŁ		
	Analog range	rRnŁŁ	4-20/1-5/5/10	4-20		
	Input-pulse frequency range	P-FrŁ	30/5P	5P	Hz	
	Scaling input value 1	ŁnP.1	-19999 ~ 99999	4.00		
	Scaling display value 1	dSP.1	-19999 ~ 99999	400		
	Scaling input value 2	ŁnP.2	-19999 ~ 99999	20.00		
	Scaling display value 2	dSP.2	-19999 ~ 99999	2000		
	Scaling input value	ŁnP	-19999 ~ 99999	5000.0		
	Scaling display value	dSP	-19999 ~ 99999	50000		
	Decimal point position	dP	0.0000/00.000/000.00/ 0000.0/00000	000.00		
	OUT1 type	ōŸŁ 1Ł	HŁ/Lō/HŁ-Lō	HŁ		
	OUT2 type	ōŸŁ 2Ł	HŁ/Lō/HŁ-Lō	Lō		
	Linear current model	ŁSEŁŁ	0-20/4-20	4-20		
	Linear voltage model	ŁSEŁŸ	0-5/1-5/0-10	1-5		
	Linear output upper limit	ŁSEŁH	-19999 ~ 99999	2000 (current) 5000 (voltage)		
	Linear output lower limit	ŁSEŁL	-19999 ~ 99999	400 (current) 1000 (voltage)		
	Move to advanced-function setting level	RŃōŸ	-19999 ~ 99999	0		
	Communication setting	Communication unit No.	Ÿ-nō	0 ~ 99	1	
Baud rate		bPS	1.2/2.4/4.8/9.6/19.2	9.6	kbps	
Word length		ŁŁn	7/8	7	bit	
Stop bit length		SbŁŁ	1/2	2	bit	
Parity check		PrtŸ	nōnŁ/EuŁŁn/ōdd	EuŁŁn		
Advanced-function setting	Parameter initialization	ŁnŁŁ	ōFF/ōn	ōFF		
	No. of measurements for averaging	RuŁ	ōFF/2/4/8	ōFF	times	
	Event input function selection	EuŁŁŁ	HōŁd/ŁŁrō	HōŁd		
	OUT1 hysteresis	HŸS 1	0 ~ 9999	1		
	OUT2 hysteresis	HŸS 2	0 ~ 9999	1		
	Auto-zero time	RŸŁōŁ	0.0 ~ 19.9	19.9	s	
	Startup compensation timer	SŁŁŃr	0.0 ~ 99.9	0.0	s	
	Display color change	ŁōŁōr	Łrn-r/Łrn/rEd-Ł/rEd	Łrn-r		
	Display auto-return time	rŁŁ	0 ~ 99	10	s	
	Move-to-protect-level time	PŁŁŁ	0 ~ 19	5	s	
	Send waiting time	SdŸŁ	0 ~ 99	20	ms	
Move to calibration level	ŁŃōŸ	-19999 ~ 99999	0			

ASCII Code Table

Upper Lower	0	1	2	3	4	5	6	7
0	NUL	DLE	SPACE	0	@	P		p
1	SOH	DC1	!	1	A	Q	a	q
2	STX	DC2	“	2	B	R	b	r
3	ETX	DC3	#	3	C	S	c	s
4	EOT	DC4	\$	4	D	T	d	t
5	ENQ	NAK	%	5	E	U	e	u
6	ACK	SYN	&	6	F	V	f	v
7	BEL	ETB	‘	7	D	W	g	w
8	BS	CAN	(8	H	X	h	x
9	HT	EM)	9	I	Y	i	y
A	LF	SUB	*	:	J	Z	j	z
B	VT	ESC	+	;	K	[k	{
C	FF	FS	,	<	L	¥	l	
D	CR	GS	-	=	M]	m	}
E	SO	RS	.	>	N	^	n	~
F	SI	US	/	?	O	_	o	DEL

Index

A

adapter 10
address 102
adjustment 38
adjustment level 40
advanced-function setting 38
advanced-function setting level 40
alphabets 44
analog input 5, 13
analog photoelectric sensor 20
analog range 51, 116
ASCII character 99
auto-zero 88
auto-zero function 24
auto-zero time 71, 117
average processing 89

B

baud rate 117
BCC 99, 100

C

calibration 38
change state 44
chattering noise removal 90
check and change OUT set value 45
clearing all parameters 65
command frame 99
command text 99
commands and responses 107
communication 14
communication parameters 63
communication procedure 98
communication reading 118
communication setting 38
communication setting level 40
communication specification 98
communication unit No. 117
communication writing 111
communication writing (setting area 0) 119
comparative output 2, 14, 93
CompoWay/F 98
contact output 5
current leakage with transistor turned ON 13
current value 115

D

decimal point position 58, 117
dimensions 10

display auto-return time 77, 117
display color 75
display color change 95, 117

E

echoback test 101, 114
end code 100
error indications 134
ETX 99, 100
event input 13, 67, 90
event input function 117
event input/pulse input 5

F

FINS 98
forced-forced-zero execution 105
forced-zero 3, 46, 90, 92
forced-zero cancel 105
forced-zero execution/cancel 111
forced-zero lockout 48, 116
frame 99

H

hexadecimal number 99
hysteresis 20, 69, 94

I

I/O circuits 5
I/O terminal connections 12
initial setting 30, 38
initial setting level 40
initial setting/communication lockouts 48, 116
input circuit diagrams 5
input pulse frequency 84, 116
input range over 30
input type 50, 116
input-pulse frequency range 52
inrush current 19
installation 10
installation procedure 11
internal block diagram 6

K

key protect 48

L

levels	38
load	14
load current	13
lower-limit action	18, 22, 24, 93
linear output	6
linear output lower limit	42, 60, 142
linear output upper limit	42, 60, 142
linear current model	142
linear voltage model	142

M

main features	2
measurement	84
Model number legend	4
monitor state	44
move to protect level	105, 112
move to setting area 1	105, 112
move-to-protect-level time	79, 117
MRC	101
MRES	101

N

N88 BASIC	123
node No.	99, 100
number of measurements for averaging	66, 89
numerics	44

O

OFF leakage current	13
ON and OFF pulses	90
ON residual current	13
operating voltage range	13
operation	38
operation instruction	101, 105, 122
operation/adjustment lockouts	48, 116
OUT1 hysteresis	117
OUT1 lower-limit value	46
OUT1 type	117
OUT1 upper-limit value	46
OUT1 value	46
OUT2 hysteresis	117
OUT2 lower-limit value	46
OUT2 type	117
OUT2 upper-limit value	46
OUT2 value	46
output circuit diagrams	5
output operating action	59
outside-the-range action	93

P

panel cutout dimensions	10
-------------------------------	----

parameter	42
parameter writing (setting area 1)	121
parity bit	117
password	40
PMCR command	125
power consumption	13
power supply	13
power supply capacity	13
pressure sensor	22
process meter	30
process value hold	90, 91
programming example	123
protect	38
protect level	40
protect level parameter writing	120
protocol macro	125
pulse input	13, 90

R

read controller attribute	101, 113
read controller status	101, 113
read from variable area	101, 103
read parameter	109
read process value	107
read remote input value	108
read status	107
read version	114
remote indicator	34
remote input value	116
response frame	100
response text	100

S

sampling	84
scaling	2, 86
scaling display value	116
scaling display value 1	116
scaling display value 2	116
scaling factor	53, 55, 86
scaling input value	116
scaling input value 1	116
scaling input value 2	116
scaling operation error	32, 57
send waiting time	81, 117
serial communication board	125
set value	44
setting areas	106
setting change lockout	48, 116
shift	3, 92
SID	99
software reset	105, 106, 112
SRC	101
SRES	101
startup compensation	88
startup compensation time	73, 117
startup compensation timer	24
status	115
stop bit length	117
STV	130

STX	99, 100
sub-address	99, 100
supply voltage	13

T

tachometer	32
teaching function	54, 56
terminal arrangement.....	12
terminal connection	12
tightening torque	11
transistor output.....	6
transmission line connection	98
twisted-pair cable	14

U

ultrasonic displacement sensor	16
upper-limit action	18, 20, 22, 24, 93
user calibration	128

V

variable.....	102
variable area	102
variable area map	115
variable type.....	102
version.....	115

W

waterproof.....	11
watertight packing.....	11
word length	117
write OUT set value	109
write parameter (setting area 1).....	110
write protect level parameter.....	110
write to variable area.....	101, 104

OMRON

OMRON Corporation **Industrial Automation Company**

Control Devices Division H.Q.

Analog Controller Division

Shiokoji Horikawa, Shimogyo-ku,
Kyoto, 600-8530 Japan

Tel: (81)75-344-7080/Fax: (81)75-344-7189

Regional Headquarters

OMRON EUROPE B.V.

Wegalaan 67-69, NL-2132 JD Hoofddorp
The Netherlands

Tel: (31)2356-81-300/Fax: (31)2356-81-388

OMRON ELECTRONICS LLC

1 East Commerce Drive, Schaumburg, IL 60173
U.S.A.

Tel: (1)847-843-7900/Fax: (1)847-843-8568

OMRON ASIA PACIFIC PTE. LTD.

83 Clemenceau Avenue,
#11-01, UE Square,
239920 Singapore

Tel: (65)6835-3011/Fax: (65)6835-2711

OMRON (CHINA) CO., LTD.

Room 2211, Bank of China Tower,
200 Yin Cheng Road (M),
Shanghai, 200120 China

Tel: (86)21-5037-2222/Fax: (86)21-5037-2200

Authorized Distributor: