

Detects Objects in Multiple Directions with High Sensitivity, Ideal for Robotics

- Detects object contact from multiple directions and operates even with a slight force.
- Slow-action switching mechanism used. Movement differential as small as 0.01 mm assures high accuracy of detection.
- Gold-plated contact with coil spring capable of switching micro current/voltage load while providing high contact reliability.
- Highly resistant to dust, fine particles and water or oil splash, conforming to IP67.
- Three sizes (M10, M8, and M5) and three types of actuators (hemispheric, cone-shaped, and wobble stick).

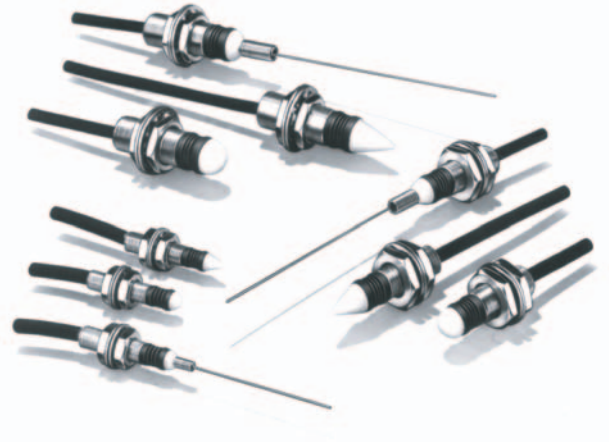

Ordering Information

Model Number Legend

D5B-□□□
1 2 3

1. Size

5: M5
8: M8
1: M10



3. Cable length

1: 1 m
3: 3 m
5: 5 m

2. Actuator

01: Hemispheric
02: Cone-shaped
51: Wobble stick (short spring)
53: Wobble stick (long spring). Only with the M10 type.

List of Models

| Type | Cable length | M5 | M8 | M10 | |
|---|---------------------|----------|----------|----------|----------|
| Hemispheric actuator  | 1 m | D5B-5011 | D5B-8011 | D5B-1011 | |
| | 3 m | D5B-5013 | D5B-8013 | D5B-1013 | |
| | 5 m | D5B-5015 | D5B-8015 | D5B-1015 | |
| Cone-shaped actuator  | 1 m | D5B-5021 | D5B-8021 | D5B-1021 | |
| | 3 m | D5B-5023 | D5B-8023 | D5B-1023 | |
| | 5 m | D5B-5025 | D5B-8025 | D5B-1025 | |
| Wobble stick actuator  | Short spring | 1 m | D5B-5511 | D5B-8511 | D5B-1511 |
| | | 3 m | D5B-5513 | D5B-8513 | D5B-1513 |
| | | 5 m | D5B-5515 | D5B-8515 | D5B-1515 |
| | Long spring | 1 m | --- | --- | D5B-1531 |
| | | 3 m | --- | --- | D5B-1533 |
| | | 5 m | --- | --- | D5B-1535 |

Specifications

■ Ratings

| | |
|-----------------|---|
| Switching power | 1 mA at 5 VDC to 30 mA at 30 VDC (resistive load) |
|-----------------|---|

■ Characteristics

| | |
|------------------------------|---|
| Degree of protection | IP67 |
| Life expectancy (see note 2) | Mechanical: 10,000,000 operations min. Electrical: 5,000,000 operations min. (at 30 VDC, 30-mA resistive load) |
| Operating speed | 5 to 500 mm/s |
| Operating frequency | Mechanical: 120 operations/min. Electrical: 60 operations/min. |
| Insulation resistance | 100 MΩ min. at 250 VDC between each terminal and ground |
| Contact resistance | With 1 m cable: 700 mΩ max. (initial value) With 3 m cable: 1.9 Ω max. (initial value) With 5 m cable: 3.1 Ω max. (initial value) |
| Dielectric strength | 250 VAC, 50/60 Hz for 1 min between terminals of same polarity (TTP) 1,000 VAC, 50/60 Hz for 1 min between current-carrying metal parts and ground (600 VAC for M5 model) |
| Vibration resistance | Malfunction: 10 to 55 Hz, 1.5-mm double amplitude (see note 3) |
| Shock resistance | Mechanical: 1,000 m/s ² min. Malfunction: 300 m/s ² min. (see note 4) |
| Ambient temperature | Operating: -10°C to 70°C (with no icing) |
| Ambient humidity | Operating: 95% max. |
| Actuator strength | 14.7 N {1.5 kgf} (see note 5) |
| Weight | Switch: M5: approx. 14 g, M8: approx. 20 g, M10: approx. 21 g Cable: approx. 10 g/m |

Note: 1. The above figures are initial values.

2. Life expectancy values are calculated at an operating temperature of 5°C to 35°C, and an operating humidity of 40% to 70%. Contact your OMRON sales representative for more detailed information on other operating environments.

3. 16.7 Hz, 1.5-mm double amplitude for wobble stick models.

4. 50 m/s² min. for wobble stick models.

5. Excluding the wobble stick models.

■ Operating Characteristics

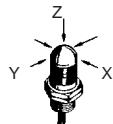
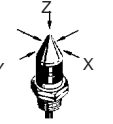
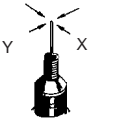
| | | TT (max.) (reference value) | | OF (max.) | | Permissible operating force (max.) | PT (reference value) | |
|---|-----|--------------------------------|--------|--------------------|-----------------|--|-------------------------|--------|
| | | X, Y | Z | X, Y | Z | | X, Y | Z |
| Hemispheric actuator  | M5 | 1.0 mm | 0.8 mm | 0.49 N {50 gf} | 0.74 N {75 gf} | 1.96 N {200 gf} | 0.6 mm | 0.3 mm |
| | M8 | 1.2 mm | 0.9 mm | 0.74 N {75 gf} | 0.98 N {100 gf} | | 0.6 mm | 0.3 mm |
| | M10 | 1.3 mm | 1.0 mm | 0.98 N {100 gf} | 1.47 N {150 gf} | | 0.7 mm | 0.3 mm |
| Cone-shaped actuator  | M5 | 2.2 mm | 0.8 mm | 0.20 N {20 gf} | 0.74 N {75 gf} | 1.96 N {200 gf} | 0.6 mm | 0.3 mm |
| | M8 | 3.0 mm | 0.9 mm | 0.20 N {20 gf} | 0.98 N {100 gf} | | 1.4 mm | 0.3 mm |
| | M10 | 4.0 mm | 1.0 mm | 0.39 N {40 gf} | 1.47 N {150 gf} | | 2.0 mm | 0.3 mm |
| Wobble stick actuator  | M5 | 22 mm | --- | 0.05 N {5 gf} max. | --- | 0.49 N {50 gf} | 11 mm | --- |
| | M8 | 23 mm | | | | | 11 mm | --- |
| | M10 | 30 mm | | | | | 14 mm | --- |

- Note:**
1. The operating characteristic values shown in the above table are measured at the portions indicated by the downward arrows in *Dimensions*.
 2. The operating principle of the Mechanical Touch Switch is similar to that of the ordinary switch in that the Mechanical Touch Switch has a switch inside the housing operated by the movement of the actuator which in turn is moved by the force applied to it. Mechanical Touch Switches differ from ordinary switches mostly in areas of operating direction flexibility, sensitivity and size.

Engineering Data

Electrical Life Expectancy ($\cos\phi = 1$)

Operating temperature: 5°C to 30°C
 Operating humidity: 40% to 70%.

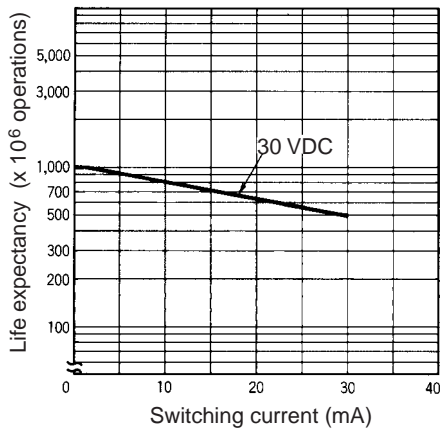

Nomenclature

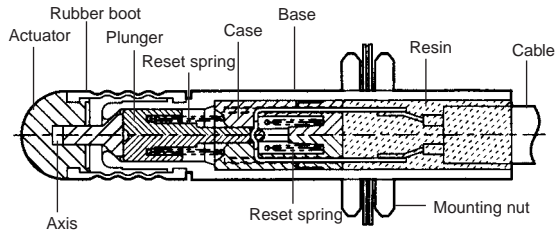

Note: NBR rubber is used with this Switch.

Operation

■ Contact Form

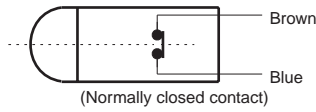

Dimensions

- Note:**
1. All units are in millimeters unless otherwise indicated.
 2. Unless otherwise specified, a tolerance of ± 0.4 mm applies to all dimensions. Values in parentheses () are cumulative values and may exceed tolerance of ± 0.4 mm.
 3. The square □ in the models represents the cable length. Refer to *Ordering Information*.

M5 Type

Hemispheric Plunger

D5B-501□

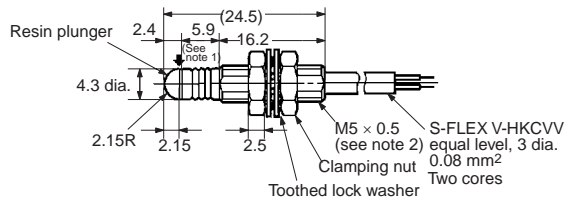
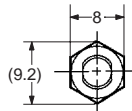

Cone-shaped Plunger

D5B-502□

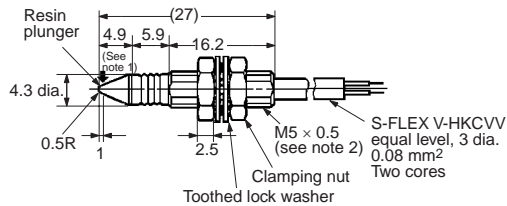
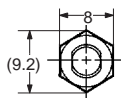

Wobble Stick

D5B-551□

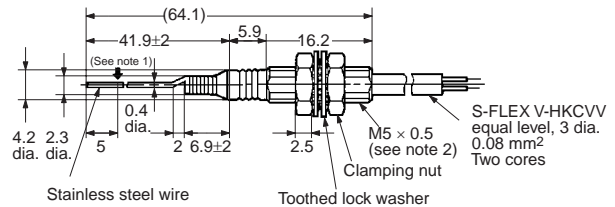
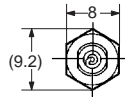
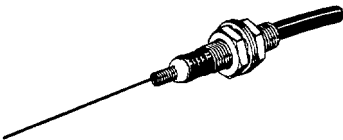

- Note:**
1. Operating characteristics (X, Y) measuring position
 2. The threads of the case are not standard; 0.5-mm pitch. There fore standard tapping to the case is not possible for mounting.

M8 Type

Hemispheric Plunger

D5B-801□

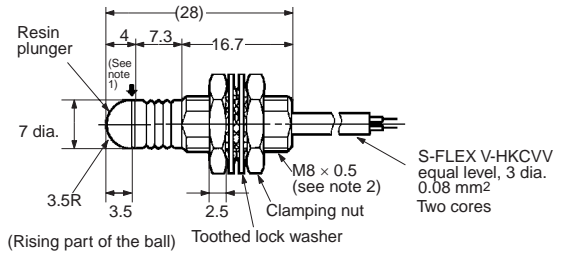
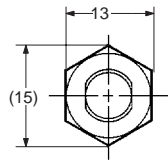
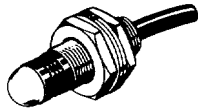

Cone-shaped Plunger

D5B-802□

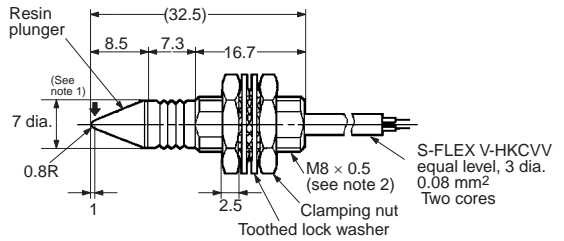
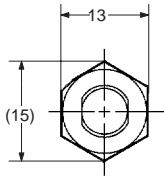
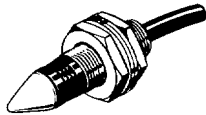

Wobble Stick

D5B-851□

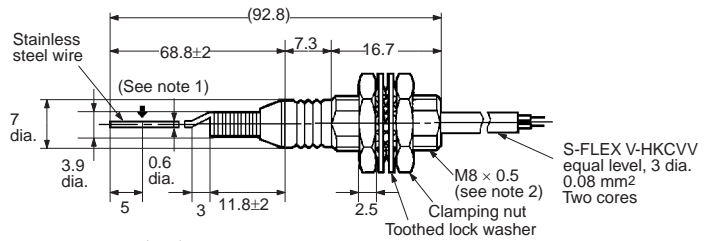
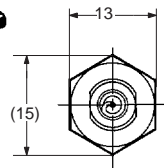
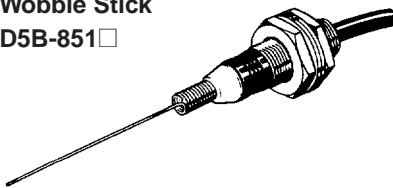

Note: 1. Operating characteristics (X, Y) measuring position
 2. The threads of the case are not standard. Therefore standard tapping to the case is not possible for mounting.

M10 Type

Hemispheric Plunger

D5B-101□

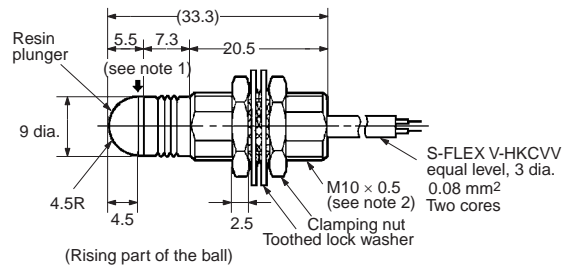
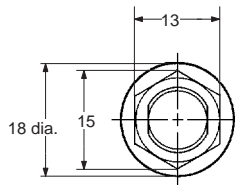
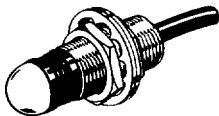

Cone-shaped Plunger

D5B-102□

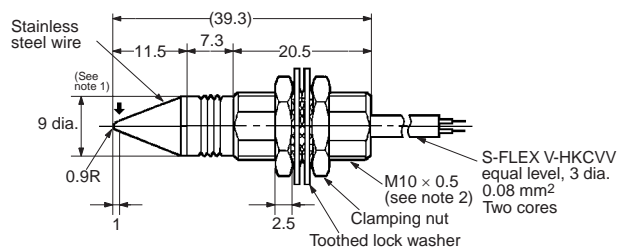
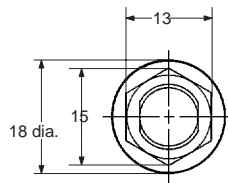
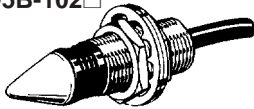

Wobble Stick

D5B-151□

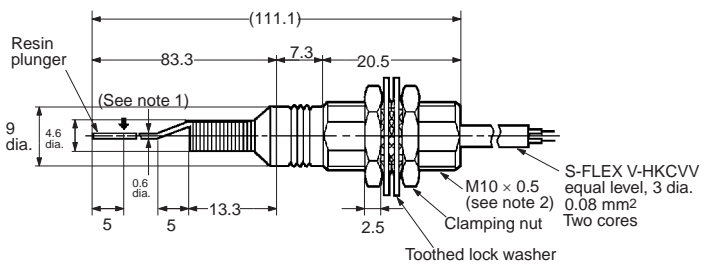
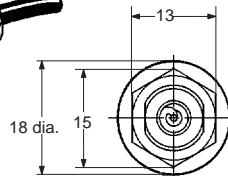
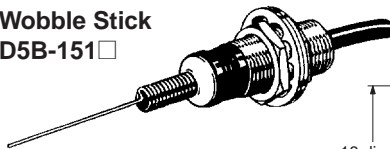

D5B-153□

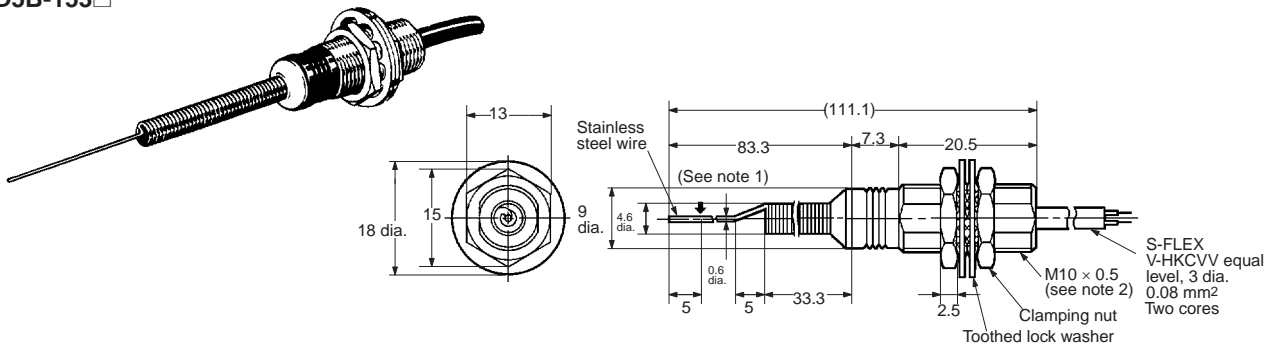

- Note:** 1. Operating characteristics (X, Y) measuring position
 2. The threads of the case are not standard. Therefore standard tapping to the case is not possible for mounting.

Precautions

■ Correct Use

Do not impose a load exceeding 29.42 N on the cord, otherwise the cord may break. If the cord is to be bent repeatedly, make sure that the bending radius is at least 20 mm.

Mounting

Do not tighten the nuts with excessive torque. Refer to the following for the appropriate tightening torque and mounting dimensions of each nut.

The base incorporates special threads that cannot be mounted to plates with standard tap holes.

| Size | Max. tightening torque | Mounting hole dimension |
|------|------------------------|---|
| M5 | 0.98 N • m | 5 dia. ⁺³ / ₀ hole |
| M8 | 2.94 N • m | 8 dia. ⁺³ / ₀ hole |
| M10 | 3.92 N • m | 10 dia. ⁺³ / ₀ hole |

An excessive load may deform the base. When mounting the base, be careful not to impose an excessive load on the base.

Operation

Do not impose excessive force on the actuator. Even though the actuator withstands a maximum force of 14.7N, if the D5B is repeatedly actuated, make sure that the maximum force imposed on the actuator is 1.96 N. If the actuator is, however, a wire spring type, the maximum force imposed must be 0.49 N instead.

The operating characteristics of the D5B vary with the direction (i.e., X, Y, or Z) in which force is imposed. Refer to page 267.

The wobble stick model is actuated when force is imposed on the tip of the wobble stick and the built-in switch unit is closed or opened. This is different from the NL Limit Touch Switch or D5C Column Touch Switch in terms of the main mechanism. The NL or D5C is actuated when the actuator comes into contact with an actuating object.

The wobble stick model may break if the stroke is excessive. Make sure that the total travel (TT) is within the reference value provided in the datasheet.

Attach an appropriate cover for protecting the D5B from direct exposure to sprayed oil or water. No protective cover is, however, provided together with the D5B.

The D5B may be damaged by ozone and failures may result if the D5B is used outdoors. Consult your OMRON representative before attempting to use the D5B outdoors.

Outdoor environmental conditions may have a bad influence on the service life of the D5B. Refer to the general precautions of Limit Switches for details.

ALL DIMENSIONS SHOWN ARE IN MILLIMETERS.
 To convert millimeters into inches, multiply by 0.03937. To convert grams into ounces, multiply by 0.03527.